



Quality Through Experience

# MARINE CABLES



### **Copyright © Notice and Disclaimer:**

All data in this catalogue are only informative. ÜNTEL KABLOLARI SAN. TIC. AS. reserve the right to modify the data at any time shown in this catalogue without notice. No part of this catalogue may be reproduced, distributed, or transmitted in any form or by any means, including photocopying, recording, or other electronic or mechanical methods, without the prior written permission of the Üntel Kablo. The names, trademarks and designs of our products are all protected by law. It does not constitute a warrantee of any kind, expressed or implied, of our products or their suitability for any particular use. There is no responsibility of the manufacturer for damages to persons and property in case of improper use, operation and installation of cables in this catalogue or/and neglecting the recommendations, standards and norms written in this catalogue.

**Rev No. CU-02-2025-R3**

# Marine Cables



Quality Through Experience

# ALMOST 50 YEARS IN PRODUCTION

**ALMOST 50 YEARS IN PRODUCTION**

Exporting Over 70 Countries on 6 Continents

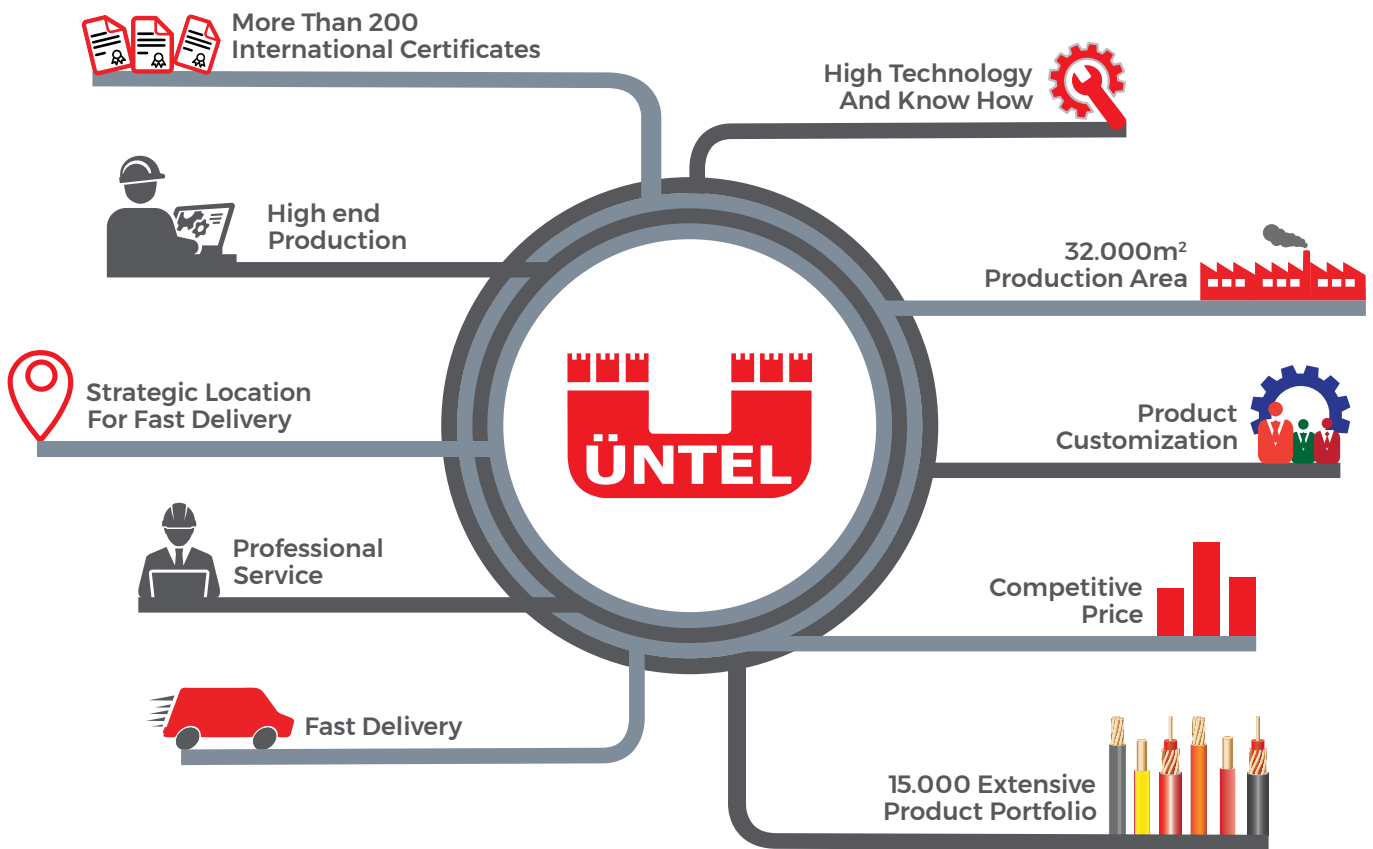

Industrial Cables



Marine Cables



Mining Cables



Offshore Cables



Railway Cables



Airport Runway Cables



Defense Cables



Crane Cables



# ABOUT US

**ÜNTEL KABLO**, one of leading cable manufacturers in the world was established in 1972, Turkey. With almost 50 years of experience, continuously develops and optimize her product range with the help of advanced technology and well trained staff.

Product range consists over 15.000 different types of cables, covers both rubber and thermoplastic cables up to Medium Voltage (MV) range. ÜNTEL's power and instrumentation cables supplies energy for industries which requires experience like marine, offshore, mines and tunnels, airports, railways and have been used in industrial ways such as heavy-duty rubber drum reeling cables, welding cables, control cables and fire resistant cables. ÜNTEL is also able to produce tailor made products for special purposes. Today these products are exported over 70 countries on six continents.

By the end of 2009, ÜNTEL finalized the investment of a new high-tech plant near Istanbul. Now continues her operations on 43.000 m<sup>2</sup> land space with 32.000 m<sup>2</sup> closed area. By having 3.000 tons copper drawing and 4.000 tons different type of

compound processing capacity, ÜNTEL produces 30.000 tones of cable per year. By means of new factory building, state of the art machines and unique ERP system investments ÜNTEL aimed absolute customer satisfaction.

Üntel's laboratories which are approved by organisations that specify the standards are equipped with advanced technology test and measurement devices. Within the scope of Quality System Certificates there is a quality management system presents in Üntel according to ISO, IQnet and TSE quality standards.. Around 200 different types of cables are certified by global organisations like VDE, KEMA, ABS, UL, BV, DNV-GL, RINA and TSE.

Üntel Kablo evaluate customer needs and expectations in a sectoral view and provide effective solutions with hundred percent customer satisfaction and qualified production philosophy. Üntel's biggest value is well trained and experienced staff and believe that exceptional quality comes through this experience.

**Üntel Kablo** offers also UL approved  
Marine cables and variety of Offshore cables



You can find also VG95218 Part 60-66 Navy type cables and  
NEK 606 & BS 6883 and TYPE P offshore cables in our portfolie with approvals.

[www.untel.com.tr](http://www.untel.com.tr)



# MARINE CABLES

Longest journeys start with “trust”.

**Üntel Kablo** is one of the leading manufacturer of marine and shipbuilding cables in Europe and has been producing with approved quality more than **45+ years**

In this catalogue Üntel Kablo presents its series of shipboard energy, control, signal and instrumentation cables for fixed installations on vessels and other marine applications.

Shipbuilding involves the construction, reparation and renewing of ships or all kind of floating vessels like Cruise ships, LNG Tankers, Container ships, FPSOs, offshore support vessels and cargo or passenger vessel. Mainly shipbuilding industry is located at coastal areas called shipyards.

From cargo ships to cruise vessels, the technology used in shipbuilding requires high performance, more reliability and more safety through a complete range of shipboard cables including power, control, instrumentation, data transmission and communication cables with the best quality. Thus, the cables used in electrical installations must be easy to install (peel and bend), light and small, waterproof, fire resistant and low smoke and halogen free.

Üntel marine cables have been approved by its customers for an easy installation, enhanced flexibility, easy pulling, easy strippable and reduced size and weight.

Üntel Kablo produces Shipbuilding Cables in accordance with IEC 60092-350, IEC 60092-353, IEC 60092-354, and IEC 60092-376 features and design principles that developed throughout years of experience.

These cables are ideally suited for permanent installation on ships and boats, especially on desks and in cabins.

Our cables are produced with best quality compounds together with our decades of production experience to create solutions and added value for shipbuilders, owners and shipyards.

Üntel LSZH Shipbuilding cables meet the high requirements of safety on board and have been developed with improved characteristics to reduce the amount of toxic and corrosive gas emitted during combustion and hence do not cause secondary damage to the control, communication and power systems nor is it a threat to human life.

Our Shipbuilding and Marine Cables have been type approved by very reputable classification institutions like TL, ABS, DNV-GL, LR, RINA, RMRS, NKK and BV

While continuously investing on Research & Development and being in the market with more than 45 years of experience, producing wide variety of cables with high-tech production machines and with well trained staff enables Üntel to satisfy customers special requests and needs by supplying the best quality products.

Please go through our product pages for further technical information, if your requirement is for more specialised or for technical support or assistance, our technical team is at your disposal.

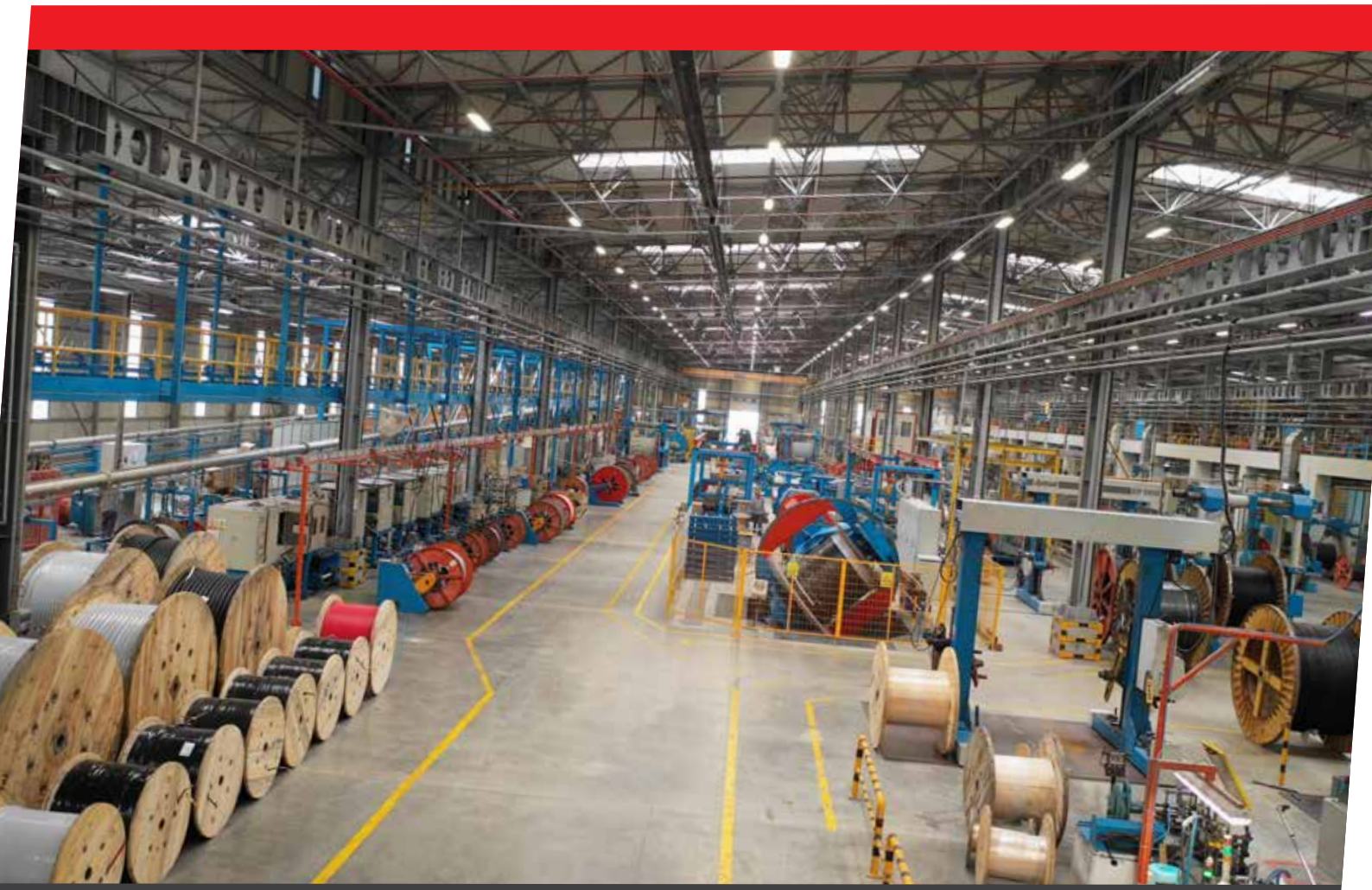

# INDEX

---

	<u>PAGE</u>
• M2X .....	10
• L-M2X .....	12
• M2XH (FI) .....	14
• M2XH (NOFI) .....	18
• M2XCH (FI).....	22
• M2XCH (NOFI) .....	26
• M2XH SECTOR (SmF) .....	30
• M2XCH SECTOR (SmF) .....	32
• M2XH-FFR SECTOR (SmF) .....	34
• M2XCH-FFR SECTOR (SmF) .....	36
• M2XH-FFR (FI) .....	38
• M2XH-FFR (NOFI) .....	42
• M2XCH-FFR (FI) .....	46
• M2XCH-FFR (NOFI) .....	50
• M2XSH .....	54
• MVCECH 3.6/6 kV .....	58
• MVCECH 6/10 kV .....	60
• MVCECH 8.7/15 kV .....	62
• MVCECH 12/20 kV .....	64
• M2XCH-VFD (1,8/3 kV) .....	66
• M2XCH-VFD (0,6/1 kV) .....	68
• M2XCH-EMC (1,8/3 kV) .....	70
• M2XCH - EMC (0,6/1 kV) .....	72
• FM2XH MULTI CORE .....	76
• FM2XCH MULTI CORE .....	80
• FM2XCH .....	84
• FM2XCCH .....	88
• FM2XAH .....	90
• FM2XAAH .....	94
• FM2XCH-FFR .....	98
• FM2XCCH-FFR .....	102
• FM2XAH-FFR .....	104
• FM2XAAH-FFR .....	108
• H07RN-F .....	110
• TECHNICAL DATA .....	116



<b>Conductor</b>	Electrolytic, stranded, annealed bare copper wire IEC 60228 Class 5 (Class 2 and / or tinned on request)
<b>Insulation</b>	Halogen free, flame retardant, cross linked polyolefin compound (HF90).
<b>Color</b>	Black, red, blue and other colours

### STANDARDS & MAIN CHARACTERISTICS

Construction	IEC 60092 / 353
Tests And Material	IEC 60092 / 350-360
Flame Retardant	IEC 60332 / 1-2, IEC 60332 / 3-22 Cat A
Halogen Content	IEC 60754 / 1-2
Smoke Emission	IEC 61034 / 1-2 ( DIN EN 50268 / 1-2)
Ozone Resistance	IEC60811 / 403
Temperature Range	-40°C / + 90°C
Min. Bending Radius (fixed)	4 x D
Rated Voltage	0,6 / 1 kV (1.2 kV)
Test Voltage	3,5 kV
UV and Sunlight Resistance	EN 50289-4-17 A&B, ISO 4892-2&3

Minimum recommended installation temperature -15°C  
 For core identification, diameter tolerances and other details see technical information section

#### Application

Fixed wiring in control panels, switch boards and various electrical enclosures and also used as fixed installation cables in various electromechanical and electronic equipments.



Halogen Free



Low Smoke Density



Flame Retardant



Rated Voltage



Test Voltage



Working Temperature



Bending Radius



No Corrosivity

Cross Section (mm <sup>2</sup> )	Nominal Overall Diameter (mm)	Approximate Weight (kg / km)	Bending Radius Fixed Min. (mm)	Max Resistance of Conductors at 20°C (ohm / km)	Current Carrying Capacity at 45°C (A)
1 x 1	2,7	15	11	19,5	16
1 x 1,5	2,9	19	12	13,3	21
1 x 2,5	3,2	28	13	7,98	29
1 x 4	3,7	41	15	4,95	39
1 x 6	4,2	59	17	3,30	50
1 x 10	5,5	98	22	1,91	71
1 x 16	6,2	148	25	1,21	93
1 x 25	8,6	240	35	0,78	122
1 x 35	9,7	330	39	0,554	152
1 x 50	11,6	464	47	0,386	195
1 x 70	13,0	648	53	0,272	240
1 x 95	14,9	841	60	0,206	286
1 x 120	17,0	1076	68	0,161	332
1 x 150	18,8	1336	76	0,129	382
1 x 185	21,5	1675	86	0,106	432
1 x 240	24,0	2172	96	0,0801	508
1 x 300	26,6	2703	107	0,0641	590



### CABLE STRUCTURE

<b>Conductor</b>	Electrolytic, stranded, annealed copper wire IEC 60228 Class 5 (Class 2 and / or tinned on request)
<b>Insulation</b>	Halogen free, flame retardant, cross linked polyolefin compound (HF90). Double insulation is available on request.
<b>Color</b>	Black, red, blue and other colours

### STANDARDS & MAIN CHARACTERISTICS

Construction	IEC 60092 / 376
Tests And Material	IEC 60092 / 350-360
Flame Retardant	IEC 60332 / 1-2, IEC 60332 / 3-22 Cat A
Halogen Content	IEC 60754 / 1-2
Smoke Emission	IEC 61034 / 1-2 ( DIN EN 50268 / 1-2)
Ozone Resistance	IEC60811 / 403
Temperature Range	-40°C / + 90°C
Min. Bending Radius (fixed)	4 x D
Rated Voltage	300 / 500 V
Test Voltage	1,5 kV
UV and Sunlight Resistance	EN 50289-4-17 A&B, ISO 4892-2&3

Minimum recommended installation temperature -15°C

For core identification, diameter tolerances and other details see technical information section

### Application

Used as fixed installation cables in various electromechanical and electronic equipments. Since it has type approval, it can be used in marine switchboards.



Halogen Free



Low Smoke Density



Flame Retardant



Rated Voltage



Test Voltage



Working Temperature



Bending Radius



No Corrosivity

Cross Section (mm <sup>2</sup> )	Nominal Overall Diameter (mm)	Approximate Weight (kg / km)	Bending Radius Fixed Min. (mm)	Max Resistance of Conductors at 20°C (ohm / km)	Current Carrying Capacity at 45°C (A)
1 x 0,50	2,1	8	10	40,40	11
1 x 0,75	2,3	11	10	26,00	13
1 x 1	2,5	14	10	19,50	16
1 x 1,5	2,9	18	12	13,30	21
1 x 2,5	3,2	28	13	7,98	29



### CABLE STRUCTURE

<b>Conductor</b>	Electrolytic, stranded, annealed copper wire IEC 60228 Class 5 (Class 2 and / or tinned on request)
<b>Insulation</b>	Cross linked polyethylene compound (XLPE).
<b>Inner Covering</b>	Halogen-free bedding compound.
<b>Outer Sheath</b>	Halogen-free, flame retardant, UV resistant, thermoplastic polyolefin based compound (SHF 1).
<b>Color</b>	Black or Grey or Red.
<b>FI</b>	With extruded bedding compound.

### STANDARDS & MAIN CHARACTERISTICS

Construction	IEC 60092 / 353
Tests And Material	IEC 60092 / 350-360
Flame Retardant	IEC 60332 / 1-2, IEC 60332 / 3-22 Cat A
Halogen Content	IEC 60754 / 1-2
Smoke Emission	IEC 61034 / 1-2 (DIN EN 50268 / 1-2) IEC
Ozone Resistance	60811 / 403
Temperature Range	-40°C / + 90°C
Min. Bending Radius (fixed)	For cables D ≤ 25 mm 4xD For cables D > 25 mm 6xD
Rated Voltage	0,6 / 1 kV (1.2 kV)
Test Voltage	3,5 kV
UV and Sunlight Resistance	EN 50289-4-17 A&B, ISO 4892-2&3

Minimum recommended installation temperature -15°C  
For core identification, diameter tolerances and current ratings etc. see technical information section

#### Application

Used as fixed installation cables in various electromechanical and electronic equipments of marine vehicles, in most areas & on open deck in ships.



Halogen Free



Low Smoke Density



Flame Retardant



Rated Voltage



Test Voltage



Working Temperature



Bending Radius



No Corrosivity

Cross Section (mm <sup>2</sup> )	Nominal Overall Diameter (mm)	Approximate Weight (kg / km)	Min. Bending Radius Fixed Installed (mm)	Max Resistance of Conductors at 20°C (ohm / km)	Current Carrying Capacity at 45°C (A)
2x1	9,2	112	37	19,5	14
2x1,5	9,6	127	39	13,3	18
2x2,5	10,5	160	42	7,98	25
2x4	11,7	211	47	4,95	33
2x6	12,8	268	51	3,30	43
2x10	15,2	402	61	1,91	60
2x16	17,4	562	70	1,21	79
2x25	22,0	874	88	0,78	104
2x35	23,8	1109	143	0,554	129
2x50	27,6	1517	166	0,386	166
2x70	32,4	2152	194	0,272	204
2x95	36,0	2724	216	0,206	243
2x120	40,0	3420	240	0,161	282
2x150	44,4	4250	266	0,129	324
2x185	49,40	5185	296	0,106	367
2x240	56,40	6893	338	0,0801	432
3x1	9,7	127	39	19,5	12
3x1,5	10,1	145	41	13,3	15
3x2,5	11,3	193	45	7,98	21
3x4	12,4	253	50	4,95	28
3x6	13,6	326	54	3,30	35
3x10	16,1	494	64	1,91	50
3x16	18,5	703	74	1,21	66
3x25	23,4	1087	140	0,78	86
3x35	25,6	1420	154	0,554	107
3x50	29,4	1927	176	0,386	137
3x70	34,8	2770	209	0,272	168
3x95	38,6	3515	232	0,206	201
3x120	43,3	4471	260	0,161	233
3x150	47,6	5503	286	0,129	268
3x185	53,4	6759	320	0,106	303
3x240	60,7	8970	364	0,0801	356

Cross Section (mm <sup>2</sup> )	Nominal Overall Diameter (mm)	Approximate Weight (kg / km)	Min. Bending Radius Fixed Installed (mm)	Max Resistance of Conductors at 20°C (ohm / km)	Current Carrying Capacity at 45°C (A)
4x1	10,4	145	42	19,5	12
4x1,5	10,9	168	44	13,3	15
4x2,5	12,2	225	49	7,98	21
4x4	13,4	300	54	4,95	28
4x6	14,9	396	60	3,30	35
4x10	17,8	610	71	1,91	50
4x16	20,4	878	82	1,21	66
4x25	25,9	1356	104	0,78	86
4x35	28,2	1775	170	0,554	107
4x50	33,2	2474	199	0,386	137
4x70	38,6	3498	232	0,272	168
4x95	43,1	4476	259	0,206	201
4x120	48,1	5664	289	0,161	233
4x150	53,3	7030	320	0,129	268
4x185	59,2	8542	355	0,106	303
4x240	67,9	11452	407	0,0801	356
5x1	11,4	173	46	19,5	10
5x1,5	11,9	201	48	13,3	13
5x2,5	13,2	266	53	7,98	17
5x4	14,7	362	59	4,95	23
5x6	16,2	474	65	3,30	29
5x10	19,6	744	78	1,91	42
5x16	22,5	1067	90	1,21	54
5x25	28,6	1650	114	0,78	71
5x35	31,7	2202	190	0,554	89
5x50	36,7	3020	220	0,386	114
5x70	43,2	4322	259	0,272	140
7x1,5	12,7	240	51	13,3	11
7x2,5	14,3	328	57	7,98	16
10x1,5	15,8	343	63	13,3	10
12x1,5	16,3	378	65	13,3	10
14x1,5	17,3	433	69	13,3	9
19x1,5	18,9	521	76	13,3	8
24x1,5	22,2	667	89	13,3	8





### CABLE STRUCTURE

<b>Conductor</b>	Electrolytic, stranded, annealed copper wire IEC 60228 Class 5 (Class 2 and / or tinned on request)
<b>Insulation</b>	Cross linked polyethylene compound (XLPE).
<b>Inner Covering</b>	Separating foil.
<b>Outer Sheath</b>	Halogen-free, flame retardant, UV resistant, polyolefin based compound (SHF 1).
<b>Color</b>	Black or Grey or Red.
<b>NOFI</b>	With separating foil

### STANDARDS & MAIN CHARACTERISTICS

Construction	IEC 60092 / 353
Tests And Material	IEC 60092 / 350-360
Flame Retardant Halogen Content	IEC 60332 / 1, IEC 60332 / 3-22 Cat A
Smoke Emission	IEC 60754 / 1-2
Ozone Resistance Working Temperature	IEC 61034 / 1-2 (DIN EN 50268 / 1-2)
Min. Bending Radius (fixed)	IEC 60811 / 403 -40°C / + 90°C
Rated Voltage	For cables D ≤ 25 mm 4xD For cables D > 25 mm 6xD
Test Voltage	0,6 / 1 kV (1.2 kV)
UV and Sunlight Resistant	3,5 kV EN 50289-4-17 A&B, ISO 4892-2&3

Minimum recommended installation temperature -15°C  
For core identification, diameter tolerances and current ratings etc. see technical information section

#### Application

Used as fixed installation cables in various electromechanical and electronic equipments of marine vehicles, in most areas & on open deck in ships.



Halogen Free



Low Smoke Density



Flame Retardant



Rated Voltage



Test Voltage



Working Temperature



Bending Radius



No Corrosivity

Cross Section (mm <sup>2</sup> )	Overall Diameter (mm)	Approximate Weight (kg / km)	Min. Bending Radius Fixed Installed (mm)	Max Resistance of Conductors at 20°C (ohm / km)	Current Carrying Capacity at 45°C (A)
1x1	4,8	32	19	19,5	16
1x1,5	5,0	37	20	13,3	21
1x2,5	5,5	48	22	7,98	29
1x4	6,0	64	24	4,95	39
1x6	6,5	83	26	3,30	50
1x10	7,6	127	30	1,91	71
1x16	8,8	187	35	1,21	93
1x25	10,9	280	44	0,78	122
1x35	12,0	376	72	0,554	152
1x50	13,9	518	83	0,386	195
1x70	16,0	731	96	0,272	240
1x95	17,8	938	107	0,206	286
1x120	19,9	1192	119	0,161	332
1x150	21,7	1464	130	0,129	382
1x185	24,2	1780	145	0,106	432
1x240	27,7	2390	166	0,0801	508
1x300	30,5	2936	183	0,0641	590
2x1	7,5	58	30	13,3	14
2x1,5	7,9	68	32	7,98	18
2x2,5	9,0	95	36	4,95	25
2x4	10,0	127	40	3,30	35
2x6	11,3	173	46	1,91	43
2x10	13,3	280	54	1,21	60
2x16	15,7	407	63	1,21	79
3x1	7,9	72	32	13,3	12
3x1,5	8,6	91	35	7,98	15
3x2,5	9,5	123	38	7,98	21
3x4	10,6	170	43	4,95	28
3x6	12,0	233	48	3,30	35
3x10	14,5	370	58	1,91	50
3x16	16,9	566	68	1,21	66
4x1	8,9	93	36	19,5	12
4x1,5	9,4	112	38	13,3	15

Cross Section (mm <sup>2</sup> )	Overall Diameter (mm)	Approximate Weight (kg / km)	Min. Bending Radius Fixed Installed (mm)	Max Resistance of Conductors at 20°C (ohm / km)	Current Carrying Capacity at 45°C (A)
4x2,5	10,5	154	42	7,98	21
4x4	11,9	220	48	4,95	28
4x6	13,2	297	53	3,30	35
4x10	16,1	480	65	1,91	50
4x16	18,7	707	75	1,21	66
5x1	9,7	133	39	19,5	10
5x1,5	10,2	136	41	13,3	13
5x2,5	11,7	195	47	7,98	17
5x4	13,0	271	52	4,95	23
5x6	14,7	375	59	3,30	29
5x10	17,9	601	72	1,91	42
5x16	20,8	887	84	1,21	54
7x1,5	11,2	176	45	13,3	11
7x2,5	12,6	247	51	7,98	16
7x4	14,4	365	58	4,95	21
10x1,5	14,3	257	58	13,3	10
10x2,5	16,3	367	65	7,98	14
12x1,5	14,8	287	60	13,3	10
12x4	19,5	614	78	4,95	18
14x1,5	15,6	325	63	13,3	9
14x2,5	18,0	481	72	7,98	12
16x2,5	19,0	544	76	7,98	12
19x1,5	17,4	427	70	13,3	8
20x2,5	21,2	683	85	7,98	11
24x1,5	24,3	792	98	13,3	8
30x1,5	22,0	668	88	13,3	7
30x2,5	25,3	983	127	7,98	10





## CABLE STRUCTURE

<b>Conductor</b>	Electrolytic, stranded, annealed copper wire IEC 60228 Class 5 (Class 2 and / or tinned on request)
<b>Insulation</b>	Cross linked polyethylene compound (XLPE).
<b>Inner Covering Screen</b>	Halogen-free bedding compound. Electrolytic copper braided screen (90% coverage). (Tinned copper wire braid on request)
<b>Outer Sheath</b>	Halogen-free, flame retardant, UV resistant, polyolefin based compound (SHF 1).
<b>Color</b>	Black or Grey.
<b>FI</b>	With extruded bedding compound.

## STANDARDS & MAIN CHARACTERISTICS

Construction	IEC 60092 / 353
Tests And Material	IEC 60092 / 350-360
Flame Retardant	IEC 60332 / 1-2, IEC 60332 / 3-22 Cat A
Halogen Content	IEC 60754 / 1-2
Smoke Emission	IEC 61034 / 1-2 (DIN EN 50268 / 1-2)
Ozone Resistance	IEC 60811 / 403
Working Temperature	-40°C / + 90°C
Min. Bending Radius (fixed)	6 x D
Rated Voltage	0,6 / 1 kV (1.2 kV)
Test Voltage	3,5 kV
UV and Sunlight Resistance	EN 50289-4-17 A&B, ISO 4892-2&3

Minimum recommended installation temperature -15°C

For core identification, diameter tolerances and current ratings etc. see technical information section

### Application

Used as fixed installation cables in various electromechanical and electronic equipments of marine vehicles, in most areas & open deck in ships. Due to its' overall screen the electromagnetic interference is minimized.



Halogen Free



Low Smoke Density



Flame Retardant



Rated Voltage



Test Voltage



Working Temperature



Bending Radius



No Corrosivity

Cross Section (mm <sup>2</sup> )	Overall Diameter (mm)	Approximate Weight (kg / km)	Min. Bending Radius Fixed Installed (mm)	Max Resistance of Conductors at 20°C (ohm / km)	Current Carrying Capacity at 45°C (A)
2x1	10,1	157	61	19,5	14
2x1,5	10,5	172	63	13,3	18
2x2,5	11,6	216	70	7,98	25
2x4	12,6	269	76	4,95	35
2x6	14,3	367	86	3,30	43
2x10	16,7	520	101	1,91	60
2x16	18,7	690	113	1,21	79
2x25	23,3	1034	140	0,78	104
2x35	25,3	1296	152	0,554	129
2x50	28,9	1720	174	0,386	166
2x70	33,9	2408	204	0,272	204
2x95	37,7	3078	226	0,206	243
2x120	41,9	3833	252	0,161	282
2x150	46,3	4709	278	0,129	324
2x185	51,1	5672	307	0,106	367
2x240	58,3	7477	350	0,0801	432
3x1	10,6	173	64	19,5	12
3x1,5	11,2	200	68	13,3	15
3x2,5	12,2	247	74	7,98	21
3x4	13,9	350	84	4,95	28
3x6	15,1	432	91	3,30	35
3x10	17,6	620	106	1,91	50
3x16	20,0	848	120	1,21	66
3x25	24,9	1271	150	0,78	86
3x35	26,9	1607	162	0,554	107
3x50	30,9	2158	186	0,386	137
3x70	36,7	3130	220	0,272	168
3x95	40,3	3896	242	0,206	201
3x120	45,2	4919	271	0,161	233
3x150	49,5	5995	297	0,129	268
3x185	55,3	7311	332	0,106	303
3x240	62,6	9600	376	0,0801	356

Cross Section (mm <sup>2</sup> )	Overall Diameter (mm)	Approximate Weight (kg / km)	Min. Bending Radius Fixed Installed (mm)	Max Resistance of Conductors at 20°C (ohm / km)	Current Carrying Capacity at 45°C (A)
4x1	11,5	200	69	19,5	12
4x1,5	12,0	226	72	13,3	15
4x2,5	13,1	284	79	7,98	21
4x4	14,9	403	90	4,95	28
4x6	16,2	504	97	3,30	35
4x10	19,3	749	116	1,91	50
4x16	21,7	1028	130	1,21	66
4x25	27,4	1561	165	0,78	86
4x35	29,5	1983	177	0,554	107
4x50	34,5	2719	207	0,386	137
4x70	40,3	3876	242	0,272	168
4x95	45,0	4922	270	0,206	201
4x120	50,0	6162	300	0,161	233
4x150	55,2	7581	332	0,129	263
4x185	61,1	9160	367	0,106	303
4x240	69,6	12122	418	0,0801	356
5x1	12,3	228	74	19,5	10
5x1,5	12,8	260	77	13,3	13
5x2,5	14,7	368	88	7,98	17
5x4	16,0	470	96	4,95	23
5x6	17,7	601	107	3,30	29
5x10	20,9	887	126	1,91	42
5x16	23,8	1232	143	1,21	54
5x25	30,1	1879	181	0,78	71
5x35	33,2	2453	200	0,524	89
5x50	38,6	3398	232	0,386	114
5x70	45,1	4769	271	0,272	140
7x1,5	14,2	338	86	13,3	11
7x2,5	15,6	432	94	7,98	16
10x1,5	17,3	463	104	13,3	10
12x1,5	17,8	503	107	13,3	10
14x1,5	18,6	555	112	13,3	9
19x1,5	20,4	666	123	13,3	8
24x1,5	23,5	824	141	13,3	8





## CABLE STRUCTURE

<b>Conductor</b>	Electrolytic, stranded, annealed copper wire IEC 60228 Class 5 (Class 2 and / or tinned on request)
<b>Insulation</b>	Cross linked polyethylene compound (XLPE).
<b>Inner Covering</b>	Separating foil.
<b>Screen</b>	Electrolytic copper braided screen (90% coverage). (Tinned copper wire braid on request)
<b>Outer Sheath</b>	Halogen-free, flame retardant, UV resistant, polyolefin based compound (SHF 1).
<b>Color</b>	Black or Grey.
<b>NOFI</b>	With separating foil

## STANDARDS & MAIN CHARACTERISTICS

Construction	IEC 60092 / 353
Tests And Material	IEC 60092 / 350-360
Flame Retardant	IEC 60332 / 1-2, IEC 60332 / 3-22 Cat A
Halogen Content	IEC 60754 / 1-2
Smoke Emission	IEC 61034 / 1-2 (DIN EN 50268 / 1-2)
Ozone Resistance	IEC 60811 / 403
Temperature Range	-40°C / + 90°C
Min. Bending Radius (fixed)	6 x D
Rated Voltage	0,6 / 1 kV (1.2 kV)
Test Voltage	3,5 kV
UV and Sunlight Resistance	EN 50289-4-17 A&B, ISO 4892-2&3

Minimum recommended installation temperature -15°C

For core identification, diameter tolerances and current ratings etc. see technical information section

### Application

Used as fixed installation cables in various electromechanical and electronic equipments of marine vehicles, in most areas & open deck in ships. Due to its' overall screen the electromagnetic interference is minimized.



Halogen  
Free



Low Smoke  
Density



Flame  
Retardant



Rated  
Voltage



Test  
Voltage



Working  
Temperature



Bending  
Radius



No  
Corrosivity

Cross Section (mm <sup>2</sup> )	Overall Diameter (mm)	Approximate Weight (kg / km)	Min. Bending Radius Fixed Installed (mm)	Max Resistance of Conductors at 20°C (ohm / km)	Current Carrying Capacity at 45°C (A)
1x1	5,6	56	34	19,5	16
1x1,5	5,8	60	35	13,3	21
1x2,5	6,3	71	38	7,98	29
1x4	6,8	90	41	4,95	39
1x6	7,3	111	44	3,30	50
1x10	8,6	165	52	1,91	71
1x16	9,6	225	58	1,21	93
1x25	11,9	335	72	0,78	122
1x35	12,8	431	77	0,554	152
1x50	15,1	614	91	0,386	195
1x70	17,4	851	105	0,272	240
1x95	19,0	1062	114	0,206	286
1x120	21,1	1332	127	0,161	332
1x150	23,1	1631	139	0,129	382
1x185	25,6	1963	154	0,106	432
1x240	28,9	2586	173	0,0801	508
1x300	31,7	3152	191	0,0641	590
2x1	8,5	95	51	19,5	14
2x1,5	8,9	107	54	13,3	18
2x2,5	9,8	134	59	7,98	25
2x4	10,8	174	65	4,95	35
2x6	12,1	224	73	3,30	43
2x10	14,9	381	90	1,91	60
2x16	17,1	525	103	1,21	79
3x1	8,9	110	54	19,5	12
3x1,5	9,4	130	68	13,3	15
3x2,5	10,3	165	74	7,98	21
3x4	11,6	224	85	4,95	28
3x6	12,8	290	91	3,30	35
3x10	15,7	470	104	1,91	50
3x16	18,1	690	118	1,21	66
4x1	9,7	135	68	19,5	12
4x1,5	10,2	160	73	13,3	15

Cross Section (mm <sup>2</sup> )	Overall Diameter (mm)	Approximate Weight (kg / km)	Min. Bending Radius Fixed Installed (mm)	Max Resistance of Conductors at 20°C (ohm / km)	Current Carrying Capacity at 45°C (A)
4x2,5	11,5	210	80	7,98	21
4x4	12,7	275	92	4,95	28
4x6	14,6	395	100	3,30	35
4x10	17,5	605	113	1,91	50
4x16	20,1	850	129	1,21	66
5x1	10,5	156	63	19,5	10
5x1,5	11,2	188	67	13,3	13
5x2,5	12,5	248	75	7,98	17
5x4	14,4	368	87	4,95	23
5x6	15,9	478	96	3,30	29
5x10	19,3	736	116	1,91	42
5x16	22,2	1045	133	1,21	54
7x1,5	12,0	230	72	13,3	11
7x2,5	14,0	342	84	7,98	16
10x1,5	15,5	355	93	13,3	10
10x2,5	17,5	480	105	7,98	14
12x1,5	16,0	390	96	13,3	10
14x1,5	17,0	445	102	13,3	9
14x2,5	19,4	613	116	7,98	12
16x1,5	17,9	491	107	13,3	9
19x1,5	18,6	548	112	13,3	8
20x1,5	19,8	600	119	13,3	8
20x2,5	22,6	839	136	7,98	11
24x1,5	21,7	690	130	13,3	8
30x1,5	23,2	817	139	13,3	7





## CABLE STRUCTURE

<b>Conductor</b>	Electrolytic, stranded, annealed sector shaped copper wire to IEC 60228 Class 5 SM (Tinned on request)
<b>Insulation</b>	Cross linked polyethylene compound (XLPE).
<b>Inner Covering</b>	Separating foil.
<b>Outer Sheath</b>	Halogen-free, flame retardant, UV resistant, polyolefin based compound (SHF 1).
<b>Color</b>	Black or Grey.

## STANDARDS & MAIN CHARACTERISTICS

Construction	IEC 60092 / 353
Tests And Material	IEC 60092 / 350-360
Flame Retardant Halogen Content	IEC 60332 / 1, IEC 60332 / 3-22 Cat A
Smoke Emission	IEC 60754 / 1-2
Ozone Resistance Working Temperature Min. Bending Radius (fixed)	IEC 61034 / 1-2 (DIN EN 50268 / 1-2)
	IEC 60811 / 403
	-40°C / + 90°C
	For cables D ≤ 25 mm 4xD
	For cables D > 25 mm 6xD
Rated Voltage	0,6 / 1 kV(1,2 kV)
Test Voltage	3,5 kV
UV and Sunlight Resistance	EN 50289-4-17 A&B, ISO 4892-2&3

Minimum recommended installation temperature -15°C  
 For core identification, diameter tolerances and current ratings etc. see technical information section

### Application

Used as fixed installation cables in various electromechanical and electronic equipments of marine vehicles, in most areas & on open deck in ships.



Halogen Free



Low Smoke Density



Flame Retardant



Rated Voltage



Test Voltage



Working Temperature



Bending Radius



No Corrosivity

Cross Section (mm <sup>2</sup> )	Overall Diameter (mm) (*)	Approximate Weight (kg / km)	Min. Bending Radius Fixed Installed (mm)	Max Resistance of Conductors at 20°C (ohm / km)	Current Carrying Capacity at 45°C (A)
3x35	21,2	1125	128	0,554	107
3x50	25,6	1575	154	0,386	137
3x70	29,1	2240	175	0,272	168
3x95	31,8	2845	191	0,206	201
3x120	37,4	3640	225	0,161	233
3x150	41,3	4415	248	0,129	268
3x185	46,0	5350	276	0,106	303
3x240	51,5	7150	309	0,0801	356
4x35	25,1	1495	151	0,554	107
4x50	28,8	2045	173	0,386	137
4x70	33,7	2960	203	0,272	168
4x95	37,0	3760	222	0,206	201
4x120	41,3	4795	248	0,161	233
4x150	45,5	5795	273	0,129	268
4x185	51,0	7050	306	0,106	303
4x240	56,3	9420	338	0,0801	356

(\*) Cable diameter tolerances are  $\pm 7\%$



## CABLE STRUCTURE

<b>Conductor</b>	Electrolytic, stranded, annealed sector shaped copper wire to IEC 60228 Class 5 (Tinned on request)
<b>Insulation</b>	Cross linked polyethylene compound (XLPE).
<b>Inner Covering</b>	Separating foil.
<b>Screen</b>	Electrolytic copper braided screen (90% coverage). (Tinned copper wire braid on request)
<b>Outer Sheath</b>	Halogen-free, flame retardant, UV resistant, polyolefin based compound (SHFI).
<b>Color</b>	Black or Grey.

## STANDARDS & MAIN CHARACTERISTICS

Construction	IEC 60092 / 353
Tests And Material	IEC 60092 / 350-360
Flame Retardant	IEC 60332 / 1-2, IEC 60332 / 3-22 Cat A
Halogen Content	IEC 60754 / 1-2
Smoke Emission	IEC 61034 / 1-2 (DIN EN 50268 / 1-2)
Ozone Resistance	IEC 60811 / 403
Temperature Range	-40°C / + 90°C
Min. Bending Radius (fixed)	8 x D
Rated Voltage	0,6 / 1 kV(1,2 kV)
Test Voltage	3,5 kV
UV and Sunlight Resistance	EN 50289-4-17 A&B, ISO 4892-2&3

Minimum recommended installation temperature -15°C

For core identification, diameter tolerances and current ratings etc. see technical information section

### Application

Used as fixed installation cables in various electromechanical and electronic equipments of marine vehicles, in most areas & open deck in ships. Due to its' overall screen the electromagnetic interference is minimized.



Halogen Free



Low Smoke Density



Flame Retardant



Rated Voltage



Test Voltage



Working Temperature



Bending Radius



No Corrosivity

Cross Section (mm <sup>2</sup> )	Overall Diameter (mm) (*)	Approximate Weight (kg / km)	Min. Bending Radius Fixed Installed (mm)	Max Resistance of Conductors at 20°C (ohm / km)	Current Carrying Capacity at 45°C (A)
3x35	22,6	1275	181	0,554	107
3x50	26,8	1740	215	0,386	137
3x70	30,5	2425	244	0,272	168
3x95	33,2	3050	266	0,206	201
3x120	39,2	3970	314	0,161	233
3x150	43,0	4845	344	0,129	268
3x185	47,8	5806	383	0,106	303
3x240	53,2	7662	426	0,0801	356
4x35	26,3	1655	211	0,554	107
4x50	30,2	2240	242	0,386	137
4x70	35,0	3160	280	0,272	168
4x95	38,7	4085	310	0,206	201
4x120	43,0	5140	344	0,161	233
4x150	47,3	6255	378	0,129	263
4x185	52,7	7565	422	0,106	303
4x240	58,1	9990	465	0,0801	356

(\*) Cable diameter tolerances are  $\pm 7\%$



## CABLE STRUCTURE

<b>Conductor</b>	Electrolytic, stranded, annealed sector shaped copper wire to IEC 60228 Class 5 SM (Tinned on request)
<b>Fire Barrier</b>	Mica tape.
<b>Insulation</b>	Cross linked polyethylene compound (XLPE).
<b>Inner Covering</b>	Separating foil
<b>Outer Sheath</b>	Halogen-free, flame retardant and fire resistant, UV resistant, thermoplastic polyolefin based compound (SHFI).
<b>Color</b>	Orange or Green or Black.

## STANDARDS & MAIN CHARACTERISTICS

Construction	IEC 60092 / 353
Tests And Material	IEC 60092 / 350-360
Flame Retardant	IEC 60332 / 1-2, IEC 60332 / 3-22 Cat A
Fire Resistance	IEC 60331 / 21, IEC 60331 / 1-2
Halogen Content	IEC 60754 / 1-2
Smoke Emission	IEC 61034 / 1-2 (DIN EN 50268 / 1-2)
Ozone Resistance	IEC 60811 / 403
Working Temperature	-40°C / +90°C
Min. Bending Radius (fixed)	For cables D ≤ 25 mm 4xD For cables D > 25 mm 6xD
Rated Voltage	0,6 / 1kV(1,2 kV)
Test Voltage	3,5 kV
UV and Sunlight Resistance	EN 50289 -4-17 A&B, ISO 4892-2&3

Minimum recommended installation temperature -15°C

For core identification, diameter tolerances and current ratings etc. see technical information section

### Application

Used on marine vehicles as fixed installation cables of various electromechanical and electronic equipments, where sustainable connection during fire is required.



Halogen Free



Low Smoke Density



Flame Retardant



Rated Voltage



Test Voltage



Working Temperature



Bending Radius



No Corrosivity

Cross Section (mm <sup>2</sup> )	Overall Diameter (mm) (*)	Approximate Weight (kg / km)	Min. Bending Radius Fixed Installed (mm)	Max Resistance of Conductors at 20°C (ohm / km)	Current Carrying Capacity at 45°C (A)
3x35	22,4	1150	134	0,554	107
3x50	26,6	1600	160	0,386	137
3x70	30,3	2200	182	0,272	168
3x95	32,8	2865	197	0,206	201
3x120	38,6	3660	232	0,161	233
3x150	42,3	4445	254	0,129	268
3x185	47,2	5525	284	0,106	303
3x240	52,6	7110	316	0,0801	356
4x35	26,2	1525	158	0,554	107
4x50	30,1	2115	181	0,386	137
4x70	35,0	2900	210	0,272	168
4x95	38,2	3775	230	0,206	201
4x120	43,7	4850	263	0,161	233
4x150	46,8	5850	281	0,129	268
4x185	52,2	7275	314	0,106	303
4x240	57,7	9365	347	0,0801	356

(\*) Cable diameter tolerances are  $\pm 7\%$



## CABLE STRUCTURE

<b>Conductor</b>	Electrolytic, stranded, annealed sector shaped copper wire to IEC 60228 Class 5 SM (Tinned on request)
<b>Fire Barrier</b>	Mica tape.
<b>Insulation</b>	Cross linked polyethylene compound (XLPE).
<b>Inner Covering</b>	Separating foil
<b>Screen</b>	Electrolytic copper braided screen (min 90 % coverage) (Tinned copper wire braid on request)
<b>Outer sheath</b>	Halogen-free, flame retardant and fire resistant, UV resistant, thermoplastic polyolefin based compound (SHF1).
<b>Color</b>	Orange or Green or Black.

## STANDARDS & MAIN CHARACTERISTICS

Construction	IEC 60092 / 353
Tests And Material	IEC 60092 / 350-360
Flame Retardant	IEC 60332 / 1-2, IEC 60332 / 3-22 Cat A
Fire Resistance	IEC 60331 / 21, IEC 60331 / 1-2
Halogen Content	IEC 60754 / 1-2
Smoke Emission	IEC 61034 / 1-2 (DIN EN 50268 / 1-2)
Ozone Resistance	IEC 60811 / 403
Working Temperature	-40°C / + 90°C
Min. Bending Radius (fixed)	6xD
Rated Voltage	0,6 / 1 kV(1,2 kV)
Test Voltage	3,5 kV
UV and Sunlight Resistance	EN 50289-4-17 A&B, ISO 4892-2&3

Minimum recommended installation temperature -15°C  
For core identification, diameter tolerances and current ratings etc. see technical information section

### Application

Used on marine vehicles as fixed installation cables of various electromechanical and electronic equipments, where sustainable connection during fire is required.



Halogen Free



Low Smoke Density



Flame Retardant



Rated Voltage



Test Voltage



Working Temperature



Bending Radius



No Corrosivity

Cross Section (mm <sup>2</sup> )	Overall Diameter (mm) (*)	Approximate Weight (kg / km)	Min. Bending Radius Fixed Installed (mm)	Max Resistance of Conductors at 20°C (ohm / km)	Current Carrying Capacity at 45°C (A)
3x35	23,6	1310	142	0,554	107
3x50	28,0	1800	168	0,386	137
3x70	31,5	2415	189	0,272	168
3x95	34,0	3075	204	0,206	201
3x120	40,2	4035	242	161	233
3x150	44,1	4870	265	0,129	268
3x185	49,0	6000	294	0,106	303
3x240	54,4	7640	327	0,0801	356
4x35	27,6	1720	166	0,554	107
4x50	31,3	2330	188	0,386	137
4x70	36,7	3250	221	0,272	168
4x95	40,0	4140	240	0,206	201
4x120	45,3	5250	272	0,161	233
4x150	48,4	6310	291	0,129	268
4x185	53,8	7780	323	0,106	303
4x240	59,3	9920	356	0,0801	356

(\*) Cable diameter tolerances are  $\pm 7\%$



### CABLE STRUCTURE

<b>Conductor</b>	Electrolytic, stranded, annealed copper wire IEC 60228 Class 5 (Class 2 and / or tinned on request)
<b>Fire Barrier</b>	Mica tape.
<b>Insulation</b>	Cross linked polyethylene compound (XLPE).
<b>Inner Covering</b>	Halogen-free compound
<b>Outer Sheath</b>	Halogen-free, flame retardant, UV resistant, thermoplastic polyolefin based compound (SHF 1).
<b>Color</b>	Orange or Green.
<b>FI</b>	With extruded bedding compound.

### STANDARDS & MAIN CHARACTERISTICS

Construction	IEC 60092 / 353
Tests And Material	IEC 60092 / 350-360
Flame Retardant	IEC 60332 / 1-2, IEC 60332 / 3-22 Cat A
Fire Resistance	IEC 60331 / 21, IEC 60331 / 1-2
Halogen Content	IEC 60754 / 1-2
Smoke Emission	IEC 61034 / 1-2 (DIN EN 50268 / 1-2)
Ozone Resistance	IEC 60811 / 403
Working Temperature	-40°C / + 90°C
Min. Bending Radius (fixed)	For cables D ≤ 25 mm 4xD For cables D > 25 mm 6xD
Rated Voltage	0,6 / 1 kV(1,2 kV)
Test Voltage	3,5 kV
UV and Sunlight Resistance	EN 50289-4-17 A&B, ISO 4892-2&3

Minimum recommended installation temperature -15°C  
For core identification, diameter tolerances and current ratings etc. see technical information section

#### Application

Used on marine vehicles as fixed installation cables of various electromechanical and electronic equipments, where sustainable connection during fire is required.



Halogen Free



Low Smoke Density



Flame Retardant



Rated Voltage



Test Voltage



Working Temperature



Bending Radius



No Corrosivity

Cross Section (mm <sup>2</sup> )	Overall Diameter (mm)	Approximate Weight (kg / km)	Min. Bending Radius Fixed Installed (mm)	Max Resistance of Conductors at 20°C (ohm / km)	Current Carrying Capacity at 45°C (A)
2x1	10,0	130	40	19,5	14
2x1,5	10,4	145	42	13,3	18
2x2,5	11,5	184	46	7,98	25
2x4	12,6	236	51	4,95	33
2x6	13,6	291	55	3,30	43
2x10	16,0	428	64	1,91	60
2x16	18,2	593	73	1,21	79
2x25	22,8	912	94	0,78	104
2x35	24,8	1162	148	0,554	129
2x50	28,4	1564	171	0,386	166
2x70	33,4	2223	200	0,272	204
2x95	36,8	2785	221	0,206	243
2x120	41,0	3510	246	0,161	282
2x150	45,2	4324	272	0,129	324
2x185	50,2	5268	301	0,106	367
2x240	57,4	7015	345	0,0801	432
3x1	10,5	144	42	19,5	12
3x1,5	11,2	170	45	13,3	15
3x2,5	12,1	212	49	7,98	21
3x4	13,3	276	54	4,95	28
3x6	14,6	354	59	3,30	35
3x10	17,1	527	69	1,91	50
3x16	19,5	742	78	1,21	66
3x25	24,3	1130	144	0,78	86
3x35	26,3	1452	158	0,554	107
3x50	30,4	1985	183	0,386	137
3x70	35,7	2827	215	0,272	168
3x95	39,3	3565	236	0,206	201
3x120	44,3	4552	266	0,161	233
3x150	48,8	5560	290	0,129	268
3x185	54,1	6817	325	0,106	303
3x240	61,3	9030	368	0,0801	356

Cross Section (mm <sup>2</sup> )	Overall Diameter (mm)	Approximate Weight (kg / km)	Min. Bending Radius Fixed Installed (mm)	Max Resistance of Conductors at 20°C (ohm / km)	Current Carrying Capacity at 45°C (A)
4x1	11,6	153	46	19,5	12
4x1,5	12,0	174	48	13,3	15
4x2,5	13,1	223	53	7,98	21
4x4	14,7	306	59	4,95	28
4x6	15,9	390	64	3,30	35
4x10	18,7	594	75	1,91	50
4x16	21,4	855	86	1,21	66
4x25	26,8	1310	161	0,78	86
4x35	29,2	1720	176	0,554	107
4x50	34,1	2380	205	0,386	137
4x70	39,6	3370	238	0,272	168
4x95	44,3	4320	266	0,206	201
4x120	49,3	5463	296	0,161	233
4x150	54,4	6762	327	0,129	268
4x185	60,4	8210	363	0,106	303
4x240	68,9	10960	414	0,0801	356
5x1	12,5	200	50	19,5	10
5x1,5	13,0	230	52	13,3	13
5x2,5	14,4	300	58	7,98	17
5x4	15,9	400	64	4,95	23
5x6	17,5	518	70	3,30	29
5x10	20,7	785	83	1,91	42
5x16	23,6	1113	100	1,21	54
5x25	29,7	1708	178	0,78	71
5x35	33,0	2280	16,8	0,554	89
5x50	37,8	3100	227	0,386	114
5x70	44,5	4430	267	0,272	140
7x1,5	14,1	278	57	13,3	11
7x2,5	15,5	362	62	7,98	16
10x1,5	17,6	395	71	13,3	10
12x1,5	18,1	434	73	13,3	10
14x1,5	19,3	410	78	13,3	9
19x1,5	21,1	595	85	13,3	8
24x1,5	24,8	760	146	13,3	8





## CABLE STRUCTURE

<b>Conductor</b>	Electrolytic, stranded, annealed copper wire IEC 60228 Class 5 (Class 2 and / or tinned on request)
<b>Fire Barrier</b>	Mica tape.
<b>Insulation</b>	Cross linked polyethylene compound (XLPE).
<b>Inner Covering</b>	Separating foil
<b>Outer Sheath</b>	Halogen-free, flame retardant and fire resistant, UV resistant, thermoplastic polyolefin based compound (SHF 1).
<b>Color</b>	Orange or Green.
<b>NOFI</b>	With separating foil

## STANDARDS & MAIN CHARACTERISTICS

Construction	IEC 60092 / 353
Tests And Material	IEC 60092 / 350-360
Flame Retardant	IEC 60332 / 1-2, IEC 60332 / 3-22 Cat A
Fire Resistance	IEC 60331 / 21, IEC 60331 / 1-2
Halogen Content	IEC 60754 / 1-2
Smoke Emission	IEC 61034 / 1-2 (DIN EN 50268 / 1-2)
Ozone Resistance	IEC 60811 / 403
Working Temperature	-40°C / + 90°C
Min. Bending Radius (fixed)	For cables D ≤ 25 mm 4xD For cables D > 25 mm 6xD
Rated Voltage	0,6 / 1 kV(1,2 kV)
Test Voltage	3,5 kV
UV and Sunlight Resistance	EN 50289-4-17 A&B, ISO 4892-2&3

Minimum recommended installation temperature -15°C

For core identification, diameter tolerances and current ratings etc. see technical information section

### Application

Used on marine vehicles as fixed installation cables of various electromechanical and electronic equipments, where sustainable connection during fire is required.



Halogen Free



Low Smoke Density



Flame Retardant



Rated Voltage



Test Voltage



Working Temperature



Bending Radius



No Corrosivity

Cross Section (mm <sup>2</sup> )	Overall Diameter (mm)	Approximate Weight (kg / km)	Min. Bending Radius Fixed Installed (mm)	Max Resistance of Conductors at 20°C (ohm / km)	Current Carrying Capacity at 45°C (A)
1x1	5,2	36	21	19,5	16
1x1,5	5,4	41	22	13,3	21
1x2,5	5,9	52	24	7,98	29
1x4	6,4	70	26	4,95	39
1x6	6,9	88	28	3,30	50
1x10	8,0	133	32	1,91	71
1x16	9,3	193	37	1,21	93
1x25	11,5	293	46	0,78	122
1x35	12,4	384	50	0,554	152
1x50	14,0	530	58	0,386	195
1x70	16,6	750	67	0,272	240
1x95	18,2	950	73	0,206	286
1x120	20,3	1205	82	0,161	332
1x150	22,3	1490	90	0,129	382
1x185	24,8	1807	148	0,106	432
1x240	28,1	2408	170	0,0801	508
1x300	30,9	2956	186	0,0641	590
2x1	8,5	70	34	19,5	14
2x1,5	8,9	80	36	13,3	18
2x2,5	9,8	105	40	7,98	25
2x4	10,9	140	44	4,95	33
2x6	12,1	185	49	3,30	43
2x10	14,5	300	58	1,91	60
2x16	16,7	430	67	1,21	79
3x1	9,0	90	36	19,5	12
3x1,5	9,4	105	38	13,3	15
3x2,5	10,4	135	42	7,98	21
3x4	11,8	190	48	4,95	28
3x6	12,9	250	52	3,30	35
3x10	15,4	390	62	1,91	50
3x16	17,8	590	72	1,21	66
4x1	9,9	110	40	19,5	12
4x1,5	10,3	130	42	13,3	15
4x2,5	11,6	180	47	7,98	21

Cross Section (mm <sup>2</sup> )	Overall Diameter (mm)	Approximate Weight (kg / km)	Min. Bending Radius Fixed Installed (mm)	Max Resistance of Conductors at 20°C (ohm / km)	Current Carrying Capacity at 45°C (A)
4x4	13,0	240	52	4,95	28
4x6	14,4	320	58	3,30	35
4x10	17,2	505	69	1,91	50
4x16	19,8	740	80	1,21	66
5x1	10,8	130	44	19,5	10
5x1,5	11,5	160	46	13,3	13
5x2,5	12,7	215	51	7,98	17
5x4	14,4	305	58	4,95	23
5x6	15,8	400	64	3,30	29
5x10	19,0	630	76	1,91	42
5x16	22,1	930	89	1,21	54
7x1,5	12,4	200	50	13,3	11
7x2,5	14,0	275	56	7,98	16
10x1,5	15,9	290	64	13,3	10
12x1,5	16,6	330	67	13,3	10
14x1,5	17,6	380	71	13,3	9
19x1,5	19,6	490	79	13,3	8
24x1,5	24,3	780	130	13,3	8



UNTEL



### CABLE STRUCTURE

<b>Conductor</b>	Electrolytic, stranded, annealed copper wire IEC 60228 Class 5 (Class 2 and / or tinned on request)
<b>Fire Barrier</b>	Mica tape.
<b>Insulation</b>	Cross linked polyethylene compound (XLPE).
<b>Inner Covering</b>	Halogen - free bedding compound
<b>Screen</b>	Electrolytic copper braided screen (min 90 % coverage) (Tinned copper wire braid on request)
<b>Outer Sheath</b>	Halogen-free, flame retardant and fire resistant, UV resistant, thermoplastic polyolefin based compound (SHF 1).
<b>Color</b>	Orange or Green.
<b>FI</b>	With extruded bedding compound.

### STANDARDS & MAIN CHARACTERISTICS

Construction	IEC 60092 / 353
Tests And Material	IEC 60092 / 350-360
Flame Retardant	IEC 60332 / 1-2, IEC 60332 / 3-22 Cat A
Fire Resistance	IEC 60331 / 21, IEC 60331 / 1-2
Halogen Content	IEC 60754 / 1-2
Smoke Emission	IEC 61034 / 1-2 (DIN EN 50268 / 1-2)
Ozone Resistance	IEC 60811 / 403
Working Temperature	-40°C / + 90°C
Min. Bending Radius (fixed)	6xD
Rated Voltage	0,6 / 1 kV(1,2 kV)
Test Voltage	3,5 kV
UV and Sunlight Resistance	EN 50289-4-17 A&B, ISO 4892-2&3

Minimum recommended installation temperature -15°C  
For core identification, diameter tolerances and current ratings etc. see technical information section

#### Application

Used on marine vehicles as fixed installation cables of various electromechanical and electronic equipments, where sustainable connection during fire is required.



Halogen Free



Low Smoke Density



Flame Retardant



Rated Voltage



Test Voltage



Working Temperature



Bending Radius



No Corrosivity

Cross Section (mm <sup>2</sup> )	Overall Diameter (mm)	Approximate Weight (kg / km)	Min. Bending Radius Fixed Installed (mm)	Max Resistance of Conductors at 20°C (ohm / km)	Current Carrying Capacity at 45°C (A)
2x1	10,9	180	66	19,5	14
2x1,5	11,5	200	69	13,3	18
2x2,5	12,4	240	75	7,98	25
2x4	14,1	335	85	4,95	33
2x6	15,1	400	91	3,30	43
2x10	17,5	555	105	1,91	60
2x16	19,7	735	119	1,21	79
2x25	24,1	1080	145	0,78	104
2x35	26,1	1350	157	0,554	129
2x50	29,7	1780	178	0,386	166
2x70	34,7	2470	209	0,272	204
2x95	38,7	3165	233	0,206	243
2x120	42,7	3900	257	0,161	282
2x150	47,1	4795	283	0,129	324
2x185	52,1	5790	313	0,106	367
2x240	59,1	7585	375	0,0801	432
3x1	11,6	200	70	19,5	12
3x1,5	12,0	225	72	13,3	15
3x2,5	12,9	270	78	7,98	21
3x4	14,8	380	89	4,95	28
3x6	15,9	460	96	3,30	35
3x10	18,4	652	111	1,91	50
3x16	20,8	885	125	1,21	66
3x25	25,8	1330	155	0,78	86
3x35	27,8	1660	167	0,554	107
3x50	31,7	2210	191	0,386	137
3x70	37,3	3175	224	0,272	168
3x95	41,2	3970	248	0,206	201
3x120	45,9	4984	276	0,161	233
3x150	50,2	6058	301	0,129	268
3x185	55,9	7380	335	0,106	303
3x240	63,2	9670	380	0,0801	356

Cross Section (mm <sup>2</sup> )	Overall Diameter (mm)	Approximate Weight (kg / km)	Min. Bending Radius Fixed Installed (mm)	Max Resistance of Conductors at 20°C (ohm / km)	Current Carrying Capacity at 45°C (A)
4x1	12,5	230	75	19,5	12
4x1,5	12,9	255	78	13,1	15
4x2,5	14,6	350	88	7,98	21
4x4	16,0	445	96	4,95	28
4x6	17,4	550	105	3,30	35
4x10	20,2	790	122	1,91	50
4x16	22,9	1086	138	1,21	66
4x25	28,3	1615	170	0,78	86
4x35	30,7	2060	184	0,554	107
4x50	36,0	2890	216	0,386	137
4x70	41,5	3980	249	0,272	168
4x95	46,0	5015	276	0,206	201
4x120	51,0	6265	306	0,161	233
4x150	56,1	7685	337	0,129	268
4x185	62,1	9280	373	0,106	303
4x240	70,8	12296	425	0,0801	356
5x1	14,0	300	84	19,5	10
5x1,5	14,5	330	87	13,3	13
5x2,5	15,7	405	95	7,98	17
5x4	17,4	530	105	4,95	23
5x6	18,8	650	113	3,30	29
5x10	22,2	950	134	1,91	42
5x16	25,1	1300	151	1,21	54
5x25	31,2	1950	188	0,78	71
5x35	34,3	2525	206	0,554	89
5x50	39,7	3490	238	0,386	114
5x70	46,4	4895	278	0,272	140
7x1,5	15,4	380	93	13,3	11
7x2,5	17,0	482	102	7,98	16
10x1,5	18,9	525	114	13,3	10
12x1,5	19,6	580	118	13,3	10
14x1,5	20,6	640	124	13,3	9
19x1,5	22,6	760	136	13,3	8
24x1,5	26,1	946	157	13,3	8





### CABLE STRUCTURE

<b>Conductor</b>	Electrolytic, stranded, annealed copper wire IEC 60228 Class 5 (Class 2 and / or tinned on request)
<b>Fire Barrier</b>	Mica tape.
<b>Insulation</b>	Cross linked polyethylene compound (XLPE).
<b>Inner Coving</b>	Separating foil
<b>Screen</b>	Electrolytic copper braided screen (min 90 % coverage) (Tinned copper wire braid on request)
<b>Outer sheath</b>	Halogen-free, flame retardant and fire resistant, UV resistant thermoplastic polyolefin based compound (SHF 1).
<b>Color</b>	Orange or Green.
<b>NOFI</b>	With separating foil

### STANDARDS & MAIN CHARACTERISTICS

Construction	IEC 60092 / 353
Tests And Material	IEC 60092 / 350-360
Flame Retardant	IEC 60332 / 1-2, IEC 60332 / 3-22 Cat A
Fire Resistance	IEC 60331 / 21, IEC 60331 / 1-2
Halogen Content	IEC 60754 / 1-2
Smoke Emission	IEC 61034 / 1-2 (DIN EN 50268 / 1-2)
Ozone Resistance	IEC 60811 / 403
Working Temperature	-40°C / + 90°C
Min. Bending Radius (fixed)	6xD
Rated Voltage	0,6 / 1 kV(1,2 kV)
Test Voltage	3,5 kV
UV and Sunlight Resistance	EN 50289-4-17 A&B, ISO 4892-2&3

Minimum recommended installation temperature -15°C  
For core identification, diameter tolerances and current ratings etc. see technical information section

#### Application

Used on marine vehicles as fixed installation cables of various electromechanical and electronic equipments, where sustainable connection during fire is required.



Halogen Free



Low Smoke Density



Flame Retardant



Rated Voltage



Test Voltage



Working Temperature



Bending Radius



No Corrosivity

Cross Section (mm <sup>2</sup> )	Overall Diameter (mm)	Approximate Weight (kg / km)	Min. Bending Radius Fixed Installed (mm)	Max Resistance of Conductors at 20°C (ohm / km)	Current Carrying Capacity at 45°C (A)
1x1	6,0	58	36	19,5	16
1x1,5	6,2	65	38	13,3	21
1x2,5	6,7	80	41	7,98	29
1x4	7,2	96	44	4,95	39
1x6	7,7	120	47	3,30	50
1x10	9,0	175	54	1,91	71
1x16	10,0	240	60	1,21	93
1x25	12,3	345	74	0,78	122
1x35	13,6	480	82	0,554	152
1x50	15,5	630	93	0,386	195
1x70	17,8	870	107	0,272	240
1x95	19,6	1090	118	0,206	286
1x120	21,5	1350	129	0,161	332
1x150	23,5	1650	141	0,129	382
1x185	26,0	1985	156	0,106	432
1x240	29,3	2610	176	0,0801	508
1x300	32,1	3180	193	0,0641	590
2x1	9,3	110	56	19,5	14
2x1,5	9,7	120	59	13,3	18
2x2,5	10,6	150	64	7,98	25
2x4	11,9	195	72	4,95	33
2x6	12,9	240	78	3,30	43
2x10	15,7	402	95	1,91	60
2x16	17,9	548	108	1,21	79
3x1	9,8	130	59	19,5	12
3x1,5	10,2	145	62	13,3	15
3x2,5	11,4	190	69	7,98	21
3x4	12,6	245	76	4,95	28
3x6	14,3	345	86	3,30	35
3x10	16,8	504	101	1,91	50
3x16	19,0	710	114	1,21	66
4x1	10,7	152	65	19,5	12
4x1,5	11,3	178	68	13,1	15

Cross Section (mm <sup>2</sup> )	Overall Diameter (mm)	Approximate Weight (kg / km)	Min. Bending Radius Fixed Installed (mm)	Max Resistance of Conductors at 20°C (ohm / km)	Current Carrying Capacity at 45°C (A)
4x2,5	12,4	225	75	7,98	21
4x4	14,4	340	87	4,95	28
4x6	15,6	425	94	3,30	35
4x10	18,4	625	110	1,91	50
4x16	21,0	880	126	1,21	66
5x1	11,8	185	71	19,5	10
5x1,5	12,3	210	74	13,3	13
5x2,5	14,1	306	85	7,98	17
5x4	15,6	405	94	4,95	23
5x6	17,2	518	104	3,30	29
5x10	20,4	770	123	1,91	42
5x16	23,3	1085	140	1,21	54
7x1,5	13,6	290	82	13,3	11
7x2,5	15,2	372	92	7,98	16
10x1,5	17,3	410	104	13,3	10
12x1,5	17,8	446	107	13,3	10
14x1,5	18,8	498	113	13,3	9
19x1,5	20,8	626	125	13,3	8
24x1,5	24,3	780	146	13,3	8





## CABLE STRUCTURE

<b>Conductor</b>	Electrolytic, stranded, annealed copper wire IEC 60228 Class 5 (Class 2 and / or tinned on request)
<b>Insulation</b>	Cross linked polyethylene compound (XLPE).
<b>Inner Sheath</b>	Halogen-free bedding compound.
<b>Armor</b>	Galvanized steel wire braided armor (Min. 90% coverage).
<b>Outer sheath</b>	Halogen-free, flame retardant, UV resistant, polyolefin based compound (SHF 1).
<b>Color</b>	Black or Grey.

## STANDARDS & MAIN CHARACTERISTICS

Construction	IEC 60092 / 353
Tests And Material	IEC 60092 / 350-360
Flame Retardant	IEC 60332 / 1-2, IEC 60332 / 3-22 Cat A
Halogen Content	IEC 60754 / 1-2
Smoke Emission	IEC 61034 / 1-2 (DIN EN 50268 / 1-2)
Ozon Resistance	IEC 60811 / 403
Working Temperature	-40°C / + 90°C
Min. Bending Radius (fixed)	6xD
Rated Voltage	0,6 / 1 kV(1,2 kV)
Test Voltage	3,5 kV
UV and Sunlight Resistance	EN 50289-4-17 A&B, ISO 4892-2&3

Minimum recommended installation temperature -15°C

For core identification, diameter tolerances and current ratings etc. see technical information section

### Application

Used as fixed installation cables in various electromechanical and electronic equipments of marine vehicles, in most areas & open deck in ships.



Halogen Free



Low Smoke Density



Flame Retardant



Rated Voltage



Test Voltage



Working Temperature



Bending Radius



No Corrosivity

Cross Section (mm <sup>2</sup> )	Overall Diameter (mm)	Approximate Weight (kg / km)	Min. Bending Radius Fixed Installed (mm)	Max Resistance of Conductors at 20°C (ohm / km)	Current Carrying Capacity at 45°C (A)
2x1	10,4	165	63	19,5	14
2x1,5	10,8	178	65	13,3	18
2x2,5	11,6	215	70	7,98	25
2x4	12,6	266	76	4,95	35
2x6	14,0	350	84	3,30	43
2x10	16,8	515	101	1,91	60
2x16	18,2	656	110	1,21	79
2x25	23,4	1025	140	0,78	104
2x35	25,8	1300	155	0,554	129
2x50	29,8	1760	179	0,386	166
2x70	33,4	2326	201	0,272	204
3x1	10,8	180	65	19,5	12
3x1,5	11,4	205	69	13,3	15
3x2,5	12,1	245	73	7,98	21
3x4	13,1	310	79	4,95	28
3x6	14,6	408	88	3,30	35
3x10	17,6	610	106	1,91	50
3x16	19,3	810	116	1,21	66
3x25	24,9	1255	150	0,78	86
3x35	27,4	1605	165	0,554	107
3x50	31,8	2190	190	0,386	137
3x70	36,1	3036	217	0,272	168
3x95	40,4	3840	243	0,206	201
3x120	45,8	4925	275	0,161	233
3x150	50,0	5925	300	0,129	268
3x185	56,6	7410	340	0,106	303
3x240	62,6	9365	376	0,0801	356
4x1	11,7	210	71	19,5	12
4x1,5	12,2	235	74	13,3	15
4x2,5	13,0	285	78	7,98	21
4x4	14,6	390	88	4,95	28
4x6	15,8	490	95	3,30	35
4x10	19,3	750	116	1,91	50
4x16	21,0	995	126	1,21	66

Cross Section (mm <sup>2</sup> )	Overall Diameter (mm)	Approximate Weight (kg / km)	Min. Bending Radius Fixed Installed (mm)	Max Resistance of Conductors at 20°C (ohm / km)	Current Carrying Capacity at 45°C (A)
4x25	27,4	1570	165	0,78	86
4x35	30,3	2030	182	0,554	107
4x50	36,3	2940	218	0,386	137
4x70	39,8	3845	239	0,272	168
4x95	45,3	4955	272	0,206	201
4x120	50,7	6280	304	0,161	233
4x150	55,9	7630	336	0,129	263
4x185	63,0	9505	378	0,106	303
4x240	69,9	12076	420	0,0801	356
5x1	12,5	240	75	19,5	10
5x1,5	13,1	270	79	13,3	13
5x2,5	14,3	352	86	7,98	17
5x4	15,7	455	95	4,95	23
5x6	17,2	585	103	3,30	29
5x10	21,0	890	126	1,91	42
5x16	23,1	1200	139	1,21	54
5x25	30,2	1890	182	0,78	71
5x35	33,8	2480	203	0,524	89
5x50	40,0	3536	240	0,386	114
5x70	44,6	4720	268	0,272	140
7x1,5	14,2	335	86	13,3	11
7x2,5	15,1	415	91	7,98	16
10x1,5	17,3	450	104	13,3	10
10x2,5	18,5	565	111	7,98	14
12x1,5	17,8	496	107	13,3	10
12x2,5	19,0	630	114	7,98	13
14x1,5	18,6	555	112	13,3	9
14x2,5	20,1	715	121	7,98	12
18x1,5	20,4	670	123	13,3	8
18x2,5	22,1	874	133	7,98	11
24x1,5	23,5	830	141	13,3	8
24x2,5	25,5	1096	153	7,98	11





### CABLE STRUCTURE

<b>Conductor</b>	Electrolytic, stranded, annealed copper wire IEC 60228 Class 2 (Class 5 and / or tinned on request)
<b>Conductor Screen</b>	Semiconductive layer
<b>Insulation</b>	HF HEPR Compound
<b>Insulation Screen</b>	Semiconductive layer
<b>Core Screen</b>	Copper Tape
<b>Bedding</b>	Halogen-free bedding compound
<b>Screen</b>	Electrolytic copper braided screen (90% coverage) (Tinned copper wire braid on request)
<b>Outer Sheath</b>	Halogen-free, flame retardant, UV resistant polyolefin compound, SHF 1 (SHF2 on request)
<b>Color</b>	Red

### STANDARDS & MAIN CHARACTERISTICS

Construction	IEC 60092 / 354
Tests And Material	IEC 60092 / 350-360
Flame Retardant	IEC 60332 / 1-2, IEC 60332 / 3-22 Cat A
Halogen Content	IEC 60754 / 1-2
Smoke Emission	IEC 61034 / 1-2 (DIN EN 50268 / 1-2)
Ozone Resistance	IEC 60811 / 403
Shielding Effectiveness (For Emc Types)	DIN EN 50147-1
Working Temperature	-40°C / + 90°C
Min. Bending Radius (fixed)	For Single Core Cables 12 x D For 3 Core Cables 9 x D
Rated Voltage	3,6 / 6 kV
Test Voltage	12,5 kV
UV and Sunlight Resistance	EN 50289-4-17 A&B, ISO 4892-2&3

Minimum recommended installation temperature -15°C

For core identification, diameter tolerances and current ratings etc. see technical information section

#### Application

Medium Voltage power distribution, electric power transport between the engine room generator and electrical machines. Used as fixed installation cables in various electromechanical and electronic equipments. Due to its' overall screen the electromagnetic interference is minimized.



Halogen Free



Low Smoke Density



Flame Retardant



Rated Voltage



Test Voltage



Working Temperature



Bending Radius



No Corrosivity

Cross Section (mm <sup>2</sup> )	Nominal Overall Diameter (mm)	Approximate Weight (kg / km)	Min. Bending Radius Fixed Installed (mm)	Max Resistance of Conductors at 20°C (ohm / km)	Current Carrying Capacity at 45°C (A)
1 x 10	19,4-22,3	610	268	1,83	72
1 x 16	20,3-23,5	710	282	1,15	96
1 x 25	21,5-24,9	855	298	0,727	127
1 x 35	23,0-26,7	1000	320	0,524	157
1 x 50	23,9-27,7	1160	332	0,387	196
1 x 70	25,4-29,4	1400	352	0,268	242
1 x 95	27,3-31,6	1720	379	0,193	293
1 x 120	28,8-33,4	2020	400	0,153	339
1 x 150	30,7-35,6	2330	415	0,124	389
1 x 185	33,0-38,2	2780	458	0,0991	444
1 x 240	35,9-41,5	3530	498	0,0754	522
1 x 300	38,6-44,7	4250	536	0,0601	601
3 x 10	35,1-40,6	1950	365	1,83	50
3 x 16	36,9-42,7	2275	384	1,15	67
3 x 25	39,8-46,0	2770	414	0,727	89
3 x 35	43,4-50,2	3330	451	0,524	110
3 x 50	45,3-52,4	3875	472	0,387	137
3 x 70	48,7-56,4	4710	508	0,268	159
3 x 95	52,8-61,1	5850	550	0,193	205
3 x 120	56,3-65,2	6900	586	0,153	237
3 x 150	60,8-70,3	8050	632	0,124	272
3 x 185	64,6-74,8	9500	673	0,0991	311
3 x 240	70,3-81,3	11915	732	0,0754	365
3 x 300	76,2-88,3	14500	794	0,0601	421



## CABLE STRUCTURE

<b>Conductor</b>	Electrolytic, stranded, annealed copper wire IEC 60228 Class 2 (Class 5 and / or tinned on request)
<b>Conductor Screen</b>	Semiconductive layer
<b>Insulation</b>	HF HEPR Compound
<b>Insulation Screen</b>	Semiconductive layer
<b>Core Screen</b>	Copper Tape
<b>Bedding</b>	Halogen-free bedding compound
<b>Screen</b>	Electrolytic copper braided screen (90% coverage) (Tinned copper wire braid on request)
<b>Outer Sheath</b>	Halogen-free, flame retardant, UV resistant, polyolefin compound, SHF 1 (SHF2 on request)
<b>Color</b>	Red

## STANDARDS & MAIN CHARACTERISTICS

Construction	IEC 60092 / 354
Tests And Material	IEC 60092 / 350-360
Flame Retardant	IEC 60332 / 1-2, IEC 60332 / 3-22 Cat A
Halogen Content	IEC 60754 / 1-2
Smoke Emission	IEC 61034 / 1-2 (DIN EN 50268 / 1-2)
Ozone Resistance	IEC 60811 / 403
Shielding Effectiveness (For Emc Types)	DIN EN 50147-1
Working Temperature	-40°C / + 90°C
Min. Bending Radius (fixed)	For Single Core Cables 12 x D For 3 Core Cables 9 x D
Rated Voltage	6 / 10 kV
Test Voltage	21 kV
UV and Sunlight Resistance	EN 50289-4-17 A&B, ISO 4892-2&3

Minimum recommended installation temperature -15°C

For core identification, diameter tolerances and current ratings etc. see technical information section

### Application

Medium Voltage power distribution, electric power transport between the engine room generator and electrical machines. Used as fixed installation cables in various electromechanical and electronic equipments. Due to its' overall screen the electromagnetic interference is minimized.



Halogen Free



Low Smoke Density



Flame Retardant



Rated Voltage



Test Voltage



Working Temperature



Bending Radius



No Corrosivity

Cross Section (mm <sup>2</sup> )	Nominal Overall Diameter (mm)	Approximate Weight (kg / km)	Min. Bending Radius Fixed Installed (mm)	Max Resistance of Conductors at 20°C (ohm / km)	Current Carrying Capacity at 45°C (A)
1 x 16	22,0-25,5	810	306	1,15	96
1 x 25	23,4-27,1	970	325	0,727	127
1 x 35	24,7-28,6	1110	343	0,524	157
1 x 50	25,8-29,9	1280	358	0,387	196
1 x 70	27,3-31,6	1530	379	0,268	242
1 x 95	29,2-33,8	1860	406	0,193	293
1 x 120	30,5-35,4	2020	424	0,153	339
1 x 150	34,2-39,6	2540	475	0,124	389
1 x 185	35,3-40,9	3040	490	0,0991	444
1 x 240	38,0-44,0	3735	528	0,0754	522
1 x 300	40,5-46,9	4450	562	0,0601	601
3 x 16	41,0-47,5	2690	427	1,15	67
3 x 25	44,2-51,2	3270	460	0,727	89
3 x 35	47,3-54,7	3800	492	0,524	110
3 x 50	49,4-57,1	4380	514	0,387	137
3 x 70	52,8-61,1	5250	550	0,268	169
3 x 95	57,0-66,0	6450	594	0,193	205
3 x 120	63,6-73,6	7750	662	0,153	237
3 x 150	67,5-78,1	9050	703	0,124	272
3 x 185	68,4-79,2	10150	713	0,0991	311
3 x 240	74,1-85,8	12560	772	0,0754	365
3 x 300	80,1-92,8	15260	835	0,0601	421



## CABLE STRUCTURE

<b>Conductor</b>	Electrolytic, stranded, annealed copper wire IEC 60228 Class 2 (Class 5 and / or tinned on request)
<b>Conductor Screen</b>	Semiconductive layer
<b>Insulation</b>	HF HEPR Compound
<b>Insulation Screen</b>	Semiconductive layer
<b>Core Screen</b>	Copper Tape
<b>Bedding</b>	Halogen-free bedding compound
<b>Screen</b>	Electrolytic copper braided screen (90% coverage) (Tinned copper wire braid on request)
<b>Outer Sheath</b>	Halogen-free, flame retardant, UV resistant, polyolefin compound, SHF 1 (SHF2 on request)
<b>Color</b>	Red

## STANDARDS & MAIN CHARACTERISTICS

Construction	IEC 60092 / 354
Tests And Material	IEC 60092 / 350-360
Flame Retardant	IEC 60332 / 1-2, IEC 60332 / 3-22 Cat A
Halogen Content	IEC 60754 / 1-2
Smoke Emission	IEC 61034 / 1-2 (DIN EN 50268 / 1-2)
Ozone Resistance	IEC 60811 / 403
Shielding Effectiveness (For Emc Types)	DIN EN 50147-1
Working Temperature	-40°C / + 90°C
Min. Bending Radius (fixed)	For Single Core Cables 12 x D For 3 Core Cables 9 x D
Rated Voltage	8,7 / 15 kV
Test Voltage	30,5 kV
UV and Sunlight Resistance	EN 50289-4-17 A&B, ISO 4892-2&3

Minimum recommended installation temperature -15°C

For core identification, diameter tolerances and current ratings etc. see technical information section

### Application

Medium Voltage power distribution, electric power transport between the engine room generator and electrical machines. Used as fixed installation cables in various electromechanical and electronic equipments. Due to its' overall screen the electromagnetic interference is minimized.



Halogen Free



Low Smoke Density



Flame Retardant



Rated Voltage



Test Voltage



Working Temperature



Bending Radius



No Corrosivity

Cross Section (mm <sup>2</sup> )	Nominal Overall Diameter (mm)	Approximate Weight (kg / km)	Min. Bending Radius Fixed Installed (mm)	Max Resistance of Conductors at 20°C (ohm / km)	Current Carrying Capacity at 45°C (A)
1 x 25	25,5-29,5	1100	354	0,727	127
1 x 35	27,0-31,3	1260	376	0,524	157
1 x 50	29,1-33,7	1490	404	0,387	196
1 x 70	29,6-34,3	1700	412	0,268	242
1 x 95	31,3-36,2	2000	434	0,193	293
1 x 120	33,9-39,2	2420	470	0,153	339
1 x 150	35,8-41,4	2840	496	0,124	389
1 x 185	37,6-43,5	3250	522	0,0991	444
1 x 240	40,3-46,7	3970	560	0,0754	522
1 x 300	42,6-49,3	4650	592	0,0601	601
3 x 25	49,2-56,9	3900	512	0,727	89
3 x 35	52,2-60,4	4450	544	0,524	110
3 x 50	54,5-63,0	5070	567	0,387	137
3 x 70	58,1-67,3	6030	606	0,268	169
3 x 95	62,0-71,8	7220	646	0,193	205
3 x 120	65,0-75,3	8300	678	0,153	237
3 x 150	69,9-80,9	9600	728	0,124	272
3 x 185	73,8-85,4	11150	768	0,0991	311
3 x 240	79,1-91,6	13550	824	0,0754	365
3 x 300	85,0-98,4	16300	886	0,0601	421



### CABLE STRUCTURE

<b>Conductor</b>	Electrolytic, stranded, annealed copper wire IEC 60228 Class 2 (Class 5 and / or tinned on request)
<b>Conductor Screen</b>	Semiconductive layer
<b>Insulation</b>	HF HEPR Compound
<b>Insulation Screen</b>	Semiconductive layer
<b>Core Screen</b>	Copper Tape
<b>Bedding</b>	Halogen-free bedding compound
<b>Screen</b>	Electrolytic copper braided screen (90% coverage) (Tinned copper wire braid on request)
<b>Outer Sheath</b>	Halogen-free, flame retardant, UV resistant, polyolefin compound, SHF 1 (SHF2 on request)
<b>Color</b>	Red

### STANDARDS & MAIN CHARACTERISTICS

Construction	IEC 60092 / 354
Tests And Material	IEC 60092 / 350-360
Flame Retardant	IEC 60332 / 1-2, IEC 60332 / 3- 22 Cat A
Halogen Content	IEC 60754 / 1-2
Smoke Emission	IEC 61034 / 1-2 (DIN EN 50268 / 1-2) IEC 60811 / 403
Ozone Resistance	
Shielding Effectiveness (For Emc Types)	DIN EN 50147-1
Working Temperature	-40°C / + 90°C
Min. Bending Radius (fixed)	For Single Core Cables 12 x D For 3 Core Cables 9 x D
Rated Voltage	12 / 20 kV
Test Voltage	42 kV
UV and Sunlight Resistance	EN 50289-4-17 A&B, ISO 4892-2&3

Minimum recommended installation temperature -15°C

For core identification, diameter tolerances and current ratings etc. see technical information section

#### Application

Medium Voltage power distribution, electric power transport between the engine room generator and electrical machines. Used as fixed installation cables in various electromechanical and electronic equipments. Due to its' overall screen the electromagnetic interference is minimized.



Halogen Free



Low Smoke Density



Flame Retardant



Rated Voltage



Test Voltage



Working Temperature



Bending Radius



No Corrosivity

Cross Section (mm <sup>2</sup> )	Nominal Overall Diameter (mm)	Approximate Weight (kg / km)	Min. Bending Radius Fixed Installed (mm)	Max Resistance of Conductors at 20°C (ohm / km)	Current Carrying Capacity at 45°C (A)
1 x 35	29,1-33,7	1410	404	0,524	157
1 x 50	31,0-35,9	1600	430	0,387	196
1 x 70	31,7-36,7	1860	440	0,268	242
1 x 95	33,8-39,1	2210	470	0,193	293
1 x 120	36,3-42,1	2700	505	0,153	339
1 x 150	37,9-43,8	3030	526	0,124	389
1 x 185	39,5-45,7	3450	548	0,0991	444
1 x 240	42,-48,9	4170	586	0,0754	522
1 x 300	45,1-52,2	4950	626	0,0601	601
3 x 35	56,9-65,8	5120	592	0,524	110
3 x 50	58,9-68,1	5730	613	0,387	137
3 x 70	62,4-72,2	6710	650	0,268	169
3 x 95	66,5-76,9	7970	692	0,193	205
3 x 120	69,9-80,9	9130	728	0,153	237
3 x 150	74,1-85,8	10400	772	0,124	272
3 x 185	78,2-90,6	12020	815	0,0991	311
3 x 240	83,4-96,5	14450	868	0,0754	365
3 x 300	89,3-103,3	17300	930	0,0601	421



## CABLE STRUCTURE

Conductor	Electrolytic, stranded, annealed copper wire IEC 60228 Class 2 (Class 5 and / or tinned on request)
Insulation	Cross linked polyethylene compound (XLPE).
Inner	Separating foil and / or halogen-free compound
Covering	Copper / polyester tape coverage 100% and copper wire braided
Screen	screen min.coverage 90% (Tinned copper wire braid on request)
Outer sheath	Halogen-free, flame retardant, UV resistant, polyolefin based compound (SHFI).
Color	Black or Grey

## STANDARDS & MAIN CHARACTERISTICS

Construction	IEC 60092 / 353
Tests And Material	IEC 60092 / 350-360
Flame Retardant	IEC 60332 / 1-2, IEC 60332 / 3-22 Cat A
Halogen Content	IEC 60754 / 1-2
Smoke Emission	IEC 61034 / 1-2 (DIN EN 50268 / 1-2)
Ozone Resistance	IEC 60811 / 403
Shielding Effectiveness (For Emc Types)	DIN EN 50147-1
Working Temperature	-40°C / + 90°C
Min. Bending Radius (fixed)	6 x D
Rated Voltage	1,8 / 3 (3,6) kV
Test Voltage	6,5 kV
UV and Sunlight Resistance	EN 50289-4-17 A&B, ISO 4892-2&3

Minimum recommended installation temperature -15°C

For core identification, diameter tolerances and current ratings etc. see technical information section

### Application

Used as fixed installation cables in various electromechanical and electronic equipments. Due to its' overall screen the electromagnetic interference is minimized. It can be used as motor supply cable and for frequency converters controlled low voltage AC drives on ships, called VDF (Variable Frequency Drivers) applications.



Halogen  
Free



Low Smoke  
Density



Flame  
Retardant



Rated  
Voltage



Test  
Voltage



Working  
Temperature



Bending  
Radius



No  
Corrosivity

Cross Section (mm <sup>2</sup> )	Nominal Overall Diameter (mm)	Approximate Weight (kg / km)	Min. Bending Radius Fixed Installed (mm)	Max Resistance of Conductors at 20°C (ohm / km)	Current Carrying Capacity at 45°C (A)
1x10	13,0	295	78	1,83	72
1x16	14,6	412	88	1,15	96
1x25	15,7	512	95	0,727	127
1x35	17,2	630	103	0,524	157
1x50	18,5	790	111	0,387	196
1x70	20,2	1022	121	0,268	242
1x95	22,3	1324	134	0,193	293
1x120	23,8	1585	143	0,153	339
1x150	25,7	1980	154	0,124	389
1x185	27,8	2315	167	0,0991	444
1x240	30,4	2920	183	0,0754	522
3x16 + 3x6	27,5	1412	165	1,15	67
3x25 + 3x6	31,0	1835	186	0,727	89
3x35 + 3x6	34,0	2295	204	0,524	110
3x50 + 3x10	38,4	3014	230	0,387	137
3x70 + 3x16	41,2	3810	247	0,268	169
3x95 + 3x16	47,0	4920	282	0,193	205
3x120 + 3x25	50,4	5870	303	0,153	237
3x150 + 3x25	53,6	6804	322	0,124	272
3x185 + 3x35	59,4	8452	357	0,0991	311
3x240 + 3x50	64,8	10840	389	0,0754	365



## CABLE STRUCTURE

Conductor	Electrolytic, stranded, annealed copper wire IEC 60228 Class 2 (Class 5 and / or tinned on request)
Insulation	Cross linked polyethylene compound (XLPE). Separating foil and / or halogen-free compound
Inner Covering	Copper / polyester tape coverage 100% and copper wire braided
Screen	screen min.coverage 90% (Tinned copper wire braid on request)
Outer sheath	Halogen-free, flame retardant, UV resistant, polyolefin based compound (SHFI).
Color	Black or Grey.

## STANDARDS & MAIN CHARACTERISTICS

Construction	IEC 60092 / 353
Tests And Material	IEC 60092 / 350-360
Flame Retardant	IEC 60332 / 1-2, IEC 60332 / 3-22 Cat A
Halogen Content	IEC 60754 / 1-2
Smoke Emission	IEC 61034 / 1-2 (DIN EN 50268 / 1-2)
Ozone Resistance	IEC 60811 / 403
Shielding Effectiveness (For Emc Types)	DIN EN 50147-1
Working Temperature	-40°C / + 90°C
Min. Bending Radius (fixed)	6 x D
Rated Voltage	0,6 / 1 kV(1,2 kV)
Test Voltage	3,5 kV
UV and Sunlight Resistance	EN 50289-4-17 A&B, ISO 4892-2&3

Minimum recommended installation temperature -15°C

For core identification, diameter tolerances and current ratings etc. see technical information section

### Application

Used as fixed installation cables in various electromechanical and electronic equipments. Due to its' overall screen the electromagnetic interference is minimized. It can be used as motor supply cable and for frequency converters controlled low voltage AC drives on ships, called VFD (Variable Frequency Drivers) applications.



Halogen  
Free



Low Smoke  
Density



Flame  
Retardant



Rated  
Voltage



Test  
Voltage



Working  
Temperature



Bending  
Radius



No  
Corrosivity

Cross Section (mm <sup>2</sup> )	Nominal Overall Diameter (mm)	Approximate Weight (kg / km)	Min. Bending Radius Fixed Installed (mm)	Max Resistance of Conductors at 20°C (ohm / km)	Current Carrying Capacity at 45°C (A)
1x10	8,8	180	53	1,83	72
1x16	9,9	245	60	1,15	96
1x25	12,0	332	72	0,727	127
1x35	13,6	480	82	0,524	157
1x50	15,6	644	94	0,387	196
1x70	17,5	895	105	0,268	242
1x95	19,7	1105	118	0,193	293
1x120	21,6	1359	130	0,153	339
1x150	24,0	1698	144	0,124	389
1x185	26,7	2106	160	0,0991	444
1x240	29,8	2656	179	0,0754	522
3x16 + 3x6	22,8	1180	137	1,15	67
3x25 + 3x6	25,8	1432	155	0,727	89
3x35 + 3x6	28,4	1830	171	0,524	110
3x50 + 3x10	33,3	2589	200	0,387	137
3x70 + 3x16	36,9	3474	222	0,268	169
3x95 + 3x16	41,4	4420	248	0,193	205
3x120 + 3x25	47,2	5592	283	0,153	237
3x150+ 3x25	51,2	6150	307	0,124	272
3x185 + 3x35	54,9	7650	330	0,0991	311
3x240 + 3x50	61,1	9700	367	0,0754	365



## CABLE STRUCTURE

Conductor	Electrolytic, stranded, annealed copper wire IEC 60228 Class 2 (Class 5 and / or tinned on request)
Insulation	Cross linked polyethylene compound (XLPE).
Inner	Separating foil and / or halogen-free compound
Covering	Copper / polyester tape coverage 100% and copper wire braided
Screen	Screen min.coverage 90% (Tinned copper wire braid on request)
Outer sheath	Halogen-free, flame retardant, UV resistant, polyolefin based compound (SHFI).
Color	Black or Grey

## STANDARDS & MAIN CHARACTERISTICS

Construction	IEC 60092 / 353
Tests And Material	IEC 60092 / 350-360
Flame Retardant	IEC 60332 / 1-2, IEC 60332 / 3-22 Cat A
Halogen Content	IEC 60754 / 1-2
Smoke Emission	IEC 61034 / 1-2 (DIN EN 50268 / 1-2)
Ozone Resistance	IEC 60811 / 403
Shielding Effectiveness (For Emc Types)	DIN EN 50147-1
Working Temperature	-40°C / + 90°C
Min. Bending Radius (fixed)	6 x D
Rated Voltage	1,8 / 3 (3,6) kV
Test Voltage	6,5 kV
UV and Sunlight Resistance	EN 50289-4-17 A&B, ISO 4892-2&3

Minimum recommended installation temperature -15°C

For core identification, diameter tolerances and current ratings etc. see technical information section

### Application

Used as fixed installation cables in various electromechanical and electronic equipments. Due to its' overall screen the electromagnetic interference is minimized. It can be used as motor supply cable and for frequency converters controlled low voltage AC drives on ships, called VFD applications.



Halogen Free



Low Smoke Density



Flame Retardant



Rated Voltage



Test Voltage



Working Temperature



Bending Radius



No Corrosivity

Cross Section (mm <sup>2</sup> )	Nominal Overall Diameter (mm)	Approximate Weight (kg / km)	Min. Bending Radius Fixed Installed (mm)	Max Resistance of Conductors at 20°C (ohm / km)	Current Carrying Capacity at 45°C (A)
1x10	13,0	295	78	1,83	72
1x16	14,6	411	88	1,15	96
1x25	15,7	512	95	0,727	127
1x35	17,2	631	103	0,524	157
1x50	18,5	791	111	0,387	196
1x70	20,2	1022	121	0,268	242
1x95	22,3	1324	134	0,193	293
1x120	23,8	1585	143	0,153	339
1x150	25,7	1908	154	0,124	389
1x185	27,8	2315	167	0,0991	444
1x240	30,4	2919	183	0,0754	522
3x10	23,4	933	140	1,83	50
3x16	25,8	1214	155	1,15	67
3x25	28,3	1564	170	0,727	89
3x35	31,3	1950	188	0,524	110
3x50	34,7	2540	208	0,387	137
3x70	38,7	3400	232	0,268	169
3x95	43,0	4390	258	0,193	205
3x120	47,1	5382	283	0,153	237
3x150	50,9	6464	305	0,124	272
3x185	53,8	7928	323	0,0991	311
3x240	63,3	9480	380	0,0754	365



## CABLE STRUCTURE

Conductor	Electrolytic, stranded, annealed copper wire IEC 60228 Class 2 (Class 5 and / or tinned on request)
Insulation	Cross linked polyethylene compound (XLPE).
Inner Covering	Separating foil and / or halogen-free compound
Screen	Copper / polyester tape coverage 100% and copper wire braided screen min.coverage 90% (Tinned copper wire braid on request)
Outer sheath	Halogen-free, flame retardant, UV resistant, polyolefin based compound (SHF1).
Color	Black or Grey.

## STANDARDS & MAIN CHARACTERISTICS

Construction	IEC 60092 / 353
Tests And Material	IEC 60092 / 350-360
Flame Retardant	IEC 60332 / 1-2, IEC 60332 / 3-22 Cat A
Halogen Content	IEC 60754 / 1-2
Smoke Emission	IEC 61034 / 1-2 (DIN EN 50268 / 1-2)
Ozone Resistance	IEC 60811 / 403
Shielding Effectiveness (For Emc Types)	DIN EN 50147-1
Working Temperature	-40°C / + 90°C
Min. Bending Radius (fixed)	6 x D
Rated Voltage	0,6 / 1 kV(1,2 kV)
Test Voltage	3,5 kV
UV and Sunlight Resistance	EN 50289-4-17 A&B, ISO 4892-2&3

Minimum recommended installation temperature -15°C

For core identification, diameter tolerances and current ratings etc. see technical information section

### Application

Used as fixed installation cables in various electromechanical and electronic equipments. Due to its' overall screen the electromagnetic interference is minimized. It can be used as motor supply cable and for frequency converters controlled low voltage AC drives on ships, called VFD applications.



Halogen Free



Low Smoke Density



Flame Retardant



Rated Voltage



Test Voltage



Working Temperature



Bending Radius



No Corrosivity

Cross Section (mm <sup>2</sup> )	Nominal Overall Diameter (mm)	Approximate Weight (kg / km)	Min. Bending Radius Fixed Installed (mm)	Max Resistance of Conductors at 20°C (ohm / km)	Current Carrying Capacity at 45°C (A)
2x1	10,4	175	62	18,1	15
2x1,5	11,2	205	67	12,1	20
2x2,5	12,0	244	72	7,41	26
2x4	13,6	336	82	4,61	35
2x6	14,8	412	89	3,08	44
2x10	16,8	556	101	1,83	61
2x16	19,0	748	114	1,15	82
2x25	22,4	1056	135	0,727	108
2x35	25,2	1342	151	0,524	133
2x50	28,4	1766	170	0,387	167
2x70	32,4	2377	194	0,268	206
2x95	36,8	3183	221	0,193	249
2x120	40,4	3895	242	0,153	288
2x150	45,4	4853	272	0,124	331
2x185	50,6	6014	304	0,0991	337
2x240	56,4	7641	338	0,0754	444
3x1	10,8	197	65	18,1	13
3x1,5	11,8	223	71	12,1	16
3x2,5	12,6	274	76	7,41	21
3x4	14,7	390	88	4,61	28
3x6	15,7	479	94	3,08	36
3x10	17,7	659	106	1,83	50
3x16	20,3	915	122	1,15	67
3x25	23,6	1294	142	0,727	89
3x35	26,7	1654	160	0,524	110
3x50	30,2	2199	181	0,387	137
3x70	34,5	2990	207	0,268	169
3x95	39,4	4036	236	0,193	205
3x120	43,3	4970	260	0,153	237
3x150	48,5	6171	291	0,124	272
3x185	54,0	7657	324	0,0991	311
3x240	60,5	9837	363	0,0754	365

Cross Section (mm <sup>2</sup> )	Nominal Overall Diameter (mm)	Approximate Weight (kg / km)	Min. Bending Radius Fixed Installed (mm)	Max Resistance of Conductors at 20°C (ohm / km)	Current Carrying Capacity at 45°C (A)
4x1	11,7	220	70	18,1	13
4x1,5	12,6	264	76	12,1	16
4x2,5	13,7	328	82	7,41	21
4x4	15,6	462	94	4,61	28
4x6	17,1	589	103	3,08	36
4x10	19,3	810	116	1,83	50
4x16	22,0	1123	132	1,15	67
4x25	26,0	1608	156	0,727	89
4x35	29,4	2030	176	0,524	110
4x50	33,9	2818	204	0,387	137
4x70	38,5	3881	231	0,268	169
4x95	43,4	5123	260	0,193	205
4x120	48,5	6398	291	0,153	237
4x150	54,0	7913	324	0,124	272
4x185	60,6	9905	364	0,0991	311
4x240	67,9	12722	408	0,0754	365
5x1	12,4	247	75	18,1	10
5x1,5	13,4	294	81	12,1	13
5x2,5	15,4	407	93	7,41	17
5x4	17,1	538	103	4,61	24
5x6	18,5	679	111	3,08	30
5x10	21,1	951	127	1,83	42
5x16	24,0	1355	144	1,15	56
5x25	28,6	1937	172	0,727	74
5x35	32,9	2539	198	0,524	91
5x50	37,6	3400	226	0,387	114
5x70	42,7	4709	256	0,268	140
5x95	50,0	6380	300	0,193	170
5x120	54,9	7883	330	0,153	197
5x150	60,9	9670	366	0,124	226
5x185	68,1	12006	409	0,0991	258
5x240	76,2	15466	457	0,0754	303





### CABLE STRUCTURE

<b>Conductor</b>	Electrolytic, stranded, annealed copper wire IEC 60228 Class 2 (Class 5 and / or tinned on request)
<b>Insulation</b>	Cross linked polyethylene compound (XLPE).
<b>Inner Covering</b>	Separating foil.
<b>Outer sheath</b>	Halogen-free, flame retardant, UV resistant, polyolefin based compound (SHF 1).
<b>Color</b>	Black or Grey

### STANDARDS & MAIN CHARACTERISTICS

Construction	IEC 60092 /376
Tests and Material	IEC 60092 / 350-360
Flame Retardant	IEC 60332 /1,IEC 60332 - 3-22 CatA
Halogen Content	IEC 60754 / 1-2
Smoke Emission	IEC 61034 / 1-2 (DIN EN 50268 / 1-2
Ozone Resistance	IEC 60811 / 403
Working Temperature	-40°C / +90°C
Min. Bending Radius (fixed)	For cables D ≤ 25 mm 4xD For cables D > 25 mm 6xD
Rated Voltage	150 / 250 V (300)
Test Voltage	1,5 kV
UV and Sunlight Resistance	EN 50289-4-17 A&Bi ISO 4892-2&3

Minimum recommended installation temperature -15°C

For core identification, diameter tolerances and current ratings etc. see technical information section

#### Application

Used as control and signal cables in various electromechanical and electronic equipments of marine vehicles, in most areas & on open deck in ships.



Halogen Free



Low Smoke Density



Flame Retardant



Rated Voltage



Test Voltage



Working Temperature



Bending Radius



No Corrosivity

Cross Section (mm <sup>2</sup> )	Overall Diameter (mm)	Approximate Weight (kg / km)	Min. Bending Radius Fixed Installed (mm)	Max Resistance of Conductors at 20°C (ohm / km)	Current Carrying Capacity at 45°C (A)
2x0,5	5,5	36	22	40,4	11
3x0,5	5,8	44	24	40,4	9
4x0,5	6,3	53	26	40,4	9
5x0,5	6,8	63	28	40,4	7
7x0,5	7,2	76	29	40,4	7
10x0,5	9,1	108	37	40,4	6
12x0,5	9,4	123	38	40,4	6
16x0,5	10,4	155	42	40,4	5
19x0,5	10,8	175	44	40,4	5
24x0,5	12,7	222	51	40,4	5
30x0,5	13,4	265	54	40,4	4
36x0,5	14,6	315	59	40,4	4
2x0,75	6,3	47	26	26,0	13
3x0,75	6,7	60	27	26,0	11
4x0,75	7,2	70	29	26,0	11
5x0,75	7,9	86	32	26,0	9
7x0,75	8,6	110	35	26,0	8
10x0,75	10,7	150	43	26,0	7
12x0,75	11,3	180	46	26,0	7
16x0,75	12,5	225	75	26,0	6
19x0,75	13,0	255	52	26,0	6
24x0,75	15,3	324	62	26,0	6
30x0,75	16,2	390	65	26,0	5
36x0,75	17,6	455	71	26,0	5
2x1	6,6	54	27	19,2	16
3x1	7,0	70	28	19,2	13
4x1	7,6	82	31	19,2	13
5x1	8,5	104	34	19,2	11
7x1	9,1	128	37	19,2	10
10x1	11,5	182	46	19,2	9
12x1	11,9	208	48	19,2	8
16x1	13,1	265	53	19,2	8
19x1	14,0	310	56	19,2	7

Cross Section (mm <sup>2</sup> )	Overall Diameter (mm)	Approximate Weight (kg / km)	Min. Bending Radius Fixed Installed (mm)	Max Resistance of Conductors at 20°C (ohm / km)	Current Carrying Capacity at 45°C (A)
24x1	16,2	384	65	19,2	7
30x1	17,3	465	70	19,2	6
36x1	17,3	550	75	19,2	6
2x1,5	7,7	72	31	12,8	20
3x1,5	8,1	90	33	12,8	17
4x1,5	9,0	118	36	12,8	17
5x1,5	9,8	142	40	12,8	14
7x1,5	10,6	180	43	12,8	12
10x1,5	13,6	260	55	12,8	11
12x1,5	14,2	304	57	12,8	11
16x1,5	15,8	390	64	12,8	10
19x1,5	16,7	448	67	12,8	9
24x1,5	19,7	570	79	12,8	9
30x1,5	20,8	690	84	12,8	8
36x1,5	22,6	820	91	12,8	7
2x2,5	8,8	100	36	7,86	27
3x2,5	9,3	132	38	7,86	22
4x2,5	10,1	164	41	7,86	22
5x2,5	11,3	208	46	7,86	18
7x2,5	12,2	265	49	7,86	17
10x2,5	15,6	378	63	7,86	15
12x2,5	16,1	440	65	7,86	14
16x2,5	18,1	575	73	7,86	13
19x2,5	19,0	655	76	7,86	12
24x2,5	22,6	848	91	7,86	11
30x2,5	23,9	1020	120	7,86	10
36x2,5	26,0	1225	156	7,86	10





## CABLE STRUCTURE

<b>Conductor</b>	Electrolytic, stranded, annealed copper wire IEC 60228 Class 2 (Class 5 and / or tinned on request)
<b>Insulation</b>	Cross linked polyethylene compound (XLPE).
<b>Inner Covering</b>	Separating foil.
<b>Screen</b>	Electrolytic copper braided screen (Min. 90% coverage). (Tinned copper wire braid on request)
<b>Outer sheath</b>	Halogen-free, flame retardant, UV resistant polyolefin based compound (SHF 1).
<b>Color</b>	Black or Grey.

## STANDARDS & MAIN CHARACTERISTICS

Construction	IEC 60092 / 376
Tests and Material	IEC 60092 / 350-360
Flame Retardant	IEC 60332 / 1, IEC 60332 / 3-22 Cat A
Halogen Content	IEC 60754 / 1-2
Smoke Emission	IEC 61034 / 1-2 (DIN EN 50268 / 1-2)
Ozone Resistance	IEC 60811 / 403
Working Temperature	-40°C / + 90°C
Min. Bending Radius (fixed)	6xD
Rated Voltage	150 / 250 V
Test Voltage	1,5 kV
UV and Sunlight Resistance	EN 50289-4-17 A&B, ISO 4892-2&3

Minimum recommended installation temperature -15°C

For core identification, diameter tolerances and current ratings etc. see technical information section

### Application

Used as control and signal cables in various electromechanical and electronic equipments of marine vehicles, in most areas & open deck in ships. Due to its' overall screen the electromagnetic interference is minimized.



Halogen  
Free



Low Smoke  
Density



Flame  
Retardant



Rated  
Voltage



Test  
Voltage



Working  
Temperature



Bending  
Radius



No  
Corrosivity

Cross Section (mm <sup>2</sup> )	Overall Diameter (mm)	Approximate Weight (kg / km)	Min. Bending Radius Fixed Installed (mm)	Max Resistance of Conductors at 20°C (ohm / km)	Current Carrying Capacity at 45°C (A)
2x0,5	6,3	60	38	40,4	11
3x0,5	6,6	68	40	40,4	9
4x0,5	7,0	80	42	40,4	9
5x0,5	7,6	92	46	40,4	7
7x0,5	8,0	108	48	40,4	7
10x0,5	9,9	149	60	40,4	6
12x0,5	10,2	164	62	40,4	6
16x0,5	11,3	205	68	40,4	5
19x0,5	11,8	230	71	40,4	5
24x0,5	14,1	317	85	40,4	5
30x0,5	14,8	365	89	40,4	4
36x0,5	15,8	412	95	40,4	4
2x0,75	7,1	74	43	26,0	13
3x0,75	7,5	88	45	26,0	11
4x0,75	8,0	102	48	26,0	11
5x0,75	8,9	125	54	26,0	9
7x0,75	9,4	147	57	26,0	8
10x0,75	11,7	205	71	26,0	7
12x0,75	12,1	225	73	26,0	7
16x0,75	13,9	318	84	26,0	6
19x0,75	14,4	352	87	26,0	6
24x0,75	16,7	438	101	26,0	6
30x0,75	17,6	509	106	26,0	5
36x0,75	18,8	587	113	26,0	5
2x1	7,4	81	45	19,2	16
3x1	7,8	98	47	19,2	13
4x1	8,6	120	52	19,2	13
5x1	9,3	140	56	19,2	11
7x1	9,9	170	60	19,2	10
10x1	12,3	234	74	19,2	9
12x1	12,7	265	77	19,2	8
16x1	14,5	364	87	19,2	8
19x1	15,2	410	92	19,2	7

Cross Section (mm <sup>2</sup> )	Overall Diameter (mm)	Approximate Weight (kg / km)	Min. Bending Radius Fixed Installed (mm)	Max Resistance of Conductors at 20°C (ohm / km)	Current Carrying Capacity at 45°C (A)
24x1	17,6	506	106	19,2	7
30x1	18,5	592	111	19,2	6
36x1	20,1	696	121	19,2	6
2x1,5	8,7	110	53	12,8	20
3x1,5	9,1	132	55	12,8	17
4x1,5	9,8	155	59	12,8	17
5x1,5	10,6	180	64	12,8	14
7x1,5	11,6	234	70	12,8	12
10x1,5	15,0	360	90	12,8	11
12x1,5	15,4	400	93	12,8	11
16x1,5	17,2	500	104	12,8	10
19x1,5	17,9	565	108	12,8	9
24x1,5	20,9	710	126	12,8	9
30x1,5	22,2	840	134	12,8	8
36x1,5	23,8	981	143	12,8	7
2x2,5	9,6	139	58	7,86	27
3x2,5	10,1	173	61	7,86	22
4x2,5	10,9	210	66	7,86	22
5x2,5	12,1	252	73	7,86	18
7x2,5	13,0	321	78	7,86	17
10x2,5	17,0	495	102	7,86	15
12x2,5	17,5	555	105	7,86	14
16x2,5	19,5	705	117	7,86	13
19x2,5	20,4	806	123	7,86	12
24x2,5	23,8	1000	143	7,86	11
30x2,5	25,3	1210	152	7,86	10
36x2,5	27,4	1425	165	7,86	10





## CABLE STRUCTURE

<b>Conductor</b>	Electrolytic, stranded, annealed copper wire IEC 60228 Class 2 (Class 5 and / or tinned on request)
<b>Insulation</b>	Cross linked polyethylene compound (XLPE). Each pair formed by white cores with black numbers.
<b>Inner Covering</b>	Separating foil.
<b>Screen</b>	Electrolytic copper braided screen (Min. 90% coverage). (Tinned copper wire braid on request)
<b>Outer sheath</b>	Halogen-free, flame retardant, UV resistant, polyolefin based compound (SHF 1).
<b>Color</b>	Black or Grey.

## STANDARDS & MAIN CHARACTERISTICS

Construction	IEC 60092 / 376
Tests and Material	IEC 60092 / 350-360
Flame Retardant	IEC 60332 / 1, IEC 60332 / 3-22 Cat A
Halogen Content	IEC 60754 / 1-2
Smoke Emission	IEC 61034 / 1-2 (DIN EN 50268 / 1-2)
Ozone Resistance	IEC 60811 / 403
Working Temperature	-40°C / + 90°C
Min. Bending Radius (fixed)	6xD
Rated Voltage	150 / 250 V
Test Voltage	1,5 kV
UV and Sunlight Resistance	EN 50289-4-17 A&B, ISO 4892-2&3

Minimum recommended installation temperature -15°C

For core identification, diameter tolerances and current ratings etc. see technical information section

### Application

Used as control and signal cables in various electromechanical and electronic equipments of marine vehicles, in most areas & open deck in ships. Due to its' overall screen the electromagnetic interference is minimized.



Halogen Free



Low Smoke Density



Flame Retardant



Rated Voltage



Test Voltage



Working Temperature



Bending Radius



No Corrosivity

Cross Section (mm <sup>2</sup> )	Overall Diameter (mm)	Approximate Weight (kg / km)	Min. Bending Radius Fixed Installed (mm)	Max Resistance of Conductors at 20°C (ohm / km)	Current Carrying Capacity at 45°C (A)
1x2x0,5	6,3	58	38	40,4	11
1x4x0,5	7,0	71	42	40,4	9
2x2x0,5	8,7	98	53	40,4	9
4x2x0,5	9,2	134	56	40,4	6
5x2x0,5	10,7	155	65	40,4	6
7x2x0,5	11,7	194	71	40,4	5
8x2x0,5	12,6	217	76	40,4	5
10x2x0,5	15,1	300	91	40,4	5
12x2x0,5	15,5	330	93	40,4	5
14x2x0,5	16,2	372	98	40,4	4
16x2x0,5	17,3	420	104	40,4	4
18x2x0,5	18,1	456	109	40,4	4
19x2x0,5	18,1	468	109	40,4	4
20x2x0,5	19,0	490	114	40,4	4
24x2x0,5	19,4	560	117	40,4	4
37x2x0,5	24,1	810	145	40,4	3
1x2x0,75	7,1	75	43	26,0	13
1x4x0,75	8,0	102	48	26,0	11
2x2x0,75	10,0	124	60	26,0	11
4x2x0,75	11,7	183	71	26,0	8
5x2x0,75	12,7	213	77	26,0	7
6x2x0,75	14,3	280	86	26,0	7
7x2x0,75	14,3	300	86	26,0	7
8x2x0,75	15,3	332	92	26,0	6
10x2x0,75	17,9	414	108	26,0	6
12x2x0,75	18,5	460	111	26,0	6
14x2x0,75	19,5	520	117	26,0	5
16x2x0,75	20,6	574	124	26,0	5
18x2x0,75	21,6	628	130	26,0	5
19x2x0,75	21,6	648	130	26,0	5
20x2x0,75	22,8	695	137	26,0	5
24x2x0,75	25,4	820	153	26,0	5
37x2x0,75	29,1	1138	175	26,0	4

Cross Section (mm <sup>2</sup> )	Overall Diameter (mm)	Approximate Weight (kg / km)	Min. Bending Radius Fixed Installed (mm)	Max Resistance of Conductors at 20°C (ohm / km)	Current Carrying Capacity at 45°C (A)
1x2x1	7,4	80	45	19,2	16
1x4x1	8,6	118	52	19,2	13
2x2x1	10,5	138	63	19,2	13
4x2x1	12,3	208	74	19,2	9
5x2x1	14,0	280	84	19,2	9
6x2x1	15,0	318	90	19,2	8
7x2x1	15,0	342	90	19,2	8
8x2x1	16,2	380	98	19,2	8
10x2x1	18,9	474	114	19,2	7
12x2x1	19,7	540	119	19,2	7
14x2x1	20,6	600	124	19,2	6
16x2x1	21,7	665	131	19,2	6
18x2x1	23,0	740	138	19,2	6
19x2x1	23,0	765	138	19,2	6
20x2x1	24,1	805	145	19,2	6
24x2x1	24,7	918	149	19,2	6
37x2x1	31,0	1348	186	19,2	5
1x2x1,5	8,7	108	53	12,8	20
1x4x1,5	9,8	155	59	12,8	17
2x2x1,5	12,4	187	75	12,8	17
4x2x1,5	14,9	320	90	12,8	12
5x2x1,5	16,2	372	98	12,8	11
6x2x1,5	17,7	435	107	12,8	10
7x2x1,5	17,7	470	107	12,8	10
8x2x1,5	19,3	538	116	12,8	9
10x2x1,5	22,6	670	136	12,8	9
12x2x1,5	23,3	750	140	12,8	9
14x2x1,5	24,4	840	147	12,8	8
16x2x1,5	26,0	950	156	12,8	8
18x2x1,5	27,5	1050	165	12,8	7
19x2x1,5	27,5	1090	165	12,8	7
20x2x1,5	28,9	1150	174	12,8	7
24x2x1,5	29,3	1300	176	12,8	7
37x2x1,5	37,5	2040	225	12,8	6





### CABLE STRUCTURE

<b>Conductor</b>	Electrolytic, stranded, annealed copper wire. IEC 60228 Class 2 (Class 5 and / or tinned on request)
<b>Insulation</b>	Cross linked polyethylene compound (XLPE). Each pair formed by white cores with black numbers.
<b>Separator</b>	Separating tape over pairs.
<b>Individual Screen</b>	Electrolytic, tinned, stranded, copper drain wire and aluminum tape screen over each pair
<b>Inner Covering</b>	Separating foil.
<b>Overall Screen</b>	Electrolytic copper braided screen (Min. 90%coverage) (Tinned copper wire braid on request)
<b>Outer sheath</b>	Halogen-free, flame retardant, UV resistant, polyolefin based compound (SHF 1).
<b>Color</b>	Black or Grey.

### STANDARDS & MAIN CHARACTERISTICS

Construction	IEC 60092 / 376
Tests and Material	IEC 60092 / 350-360
Flame Retardant	IEC 60332 / 1, IEC 60332 / 3-22 Cat A
Halogen Content	IEC 60754 / 1-2
Smoke Emission	IEC 61034 / 1-2 (DIN EN 50268 / 1-2)
Ozone Resistance	IEC 60811 / 403
Working Temperature	-40°C / + 90°C
Min. Bending Radius (fixed)	6xD
Rated Voltage	150 / 250 V
Test Voltage	1,5 kV
UV and Sunlight Resistance	EN 50289-4-17 A&B, ISO 4892-2&3

Minimum recommended installation temperature -15°C  
 For core identification, diameter tolerances and current ratings etc. see technical information section

#### Application

Used as signal and communication cables in radio, radar and information systems of marine vehicles. It's twisted pairs enables proper transmission of high frequency signals, while it's overall screen minimizes environmental electromagnetic interference.



Halogen Free



Low Smoke Density



Flame Retardant



Rated Voltage



Test Voltage



Working Temperature



Bending Radius



No Corrosivity

Cross Section (mm <sup>2</sup> )	Overall Diameter (mm)	Approximate Weight (kg / km)	Min. Bending Radius Fixed Installed (mm)	Max Resistance of Conductors at 20°C (ohm / km)	Current Carrying Capacity at 45°C (A)
2x2x0,5	9,9	124	60	40,4	9
4x2x0,5	11,5	182	69	40,4	6
7x2x0,5	14,0	296	84	40,4	5
12x2x0,5	18,0	540	108	40,4	5
16x2x0,5	20,0	570	120	40,4	4
18x2x0,5	21,0	618	126	40,4	4
24x2x0,5	22,6	765	136	40,4	4
2x2x0,75	11,5	158	69	26,0	11
4x2x0,75	13,2	235	80	26,0	8
7x2x0,75	16,2	375	98	26,0	7
12x2x0,75	21,3	594	128	26,0	6
16x2x0,75	24,3	750	146	26,0	5
18x2x0,75	25,7	835	155	26,0	5
24x2x0,75	30,3	1090	182	26,0	5
2x2x1	12,1	175	73	19,2	13
4x2x1	14,5	295	87	19,2	9
7x2x1	17,2	428	104	19,2	8
12x2x1	22,6	680	136	19,2	7
16x2x1	25,8	860	155	19,2	6
18x2x1	27,1	942	163	19,2	6
24x2x1	31,9	1230	192	19,2	6
2x2x1,5	14,7	260	89	12,8	17
4x2x1,5	17,2	390	104	12,8	12
7x2x1,5	20,5	575	123	12,8	10
12x2x1,5	27,8	934	167	12,8	9
16x2x1,5	31,0	1175	186	12,8	8
18x2x1,5	32,8	1305	197	12,8	7
24x2x1,5	39,0	1790	234	12,8	7



### CABLE STRUCTURE

<b>Conductor</b>	Electrolytic, stranded, annealed copper wire IEC 60228 Class 2 (Class 5 and / or tinned on request)
<b>Insulation</b>	Cross linked polyethylene compound (XLPE). Each pair formed by white cores with black numbers.
<b>Inner Covering</b>	Separating foil.
<b>Screen</b>	Electrolytic, tinned, stranded, copper drain wire and aluminum tape overall screen.
<b>Separator (Optional)</b>	Separating foil above screen.
<b>Outer sheath</b>	Halogen-free, flame retardant, UV resistant, polyolefin based compound (SHF 1).
<b>Color</b>	Black or Grey.

### STANDARDS & MAIN CHARACTERISTICS

Construction	IEC 60092 / 376
Tests and Material	IEC 60092 / 350-360
Flame Retardant	IEC 60332 / 1, IEC 60332 / 3-22 Cat A
Halogen Content	IEC 60754 / 1-2
Smoke Emission	IEC 61034 / 1-2 (DIN EN 50268 / 1-2)
Ozone Resistance	IEC 60811 / 403
Working Temperature	-40°C / + 90°C
Min. Bending Radius (fixed)	6xD
Rated Voltage	150 / 250 V
Test Voltage	1,5 kV
UV and Sunlight Resistance	EN 50289-4-17 A&B, ISO 4892-2&3

Minimum recommended installation temperature -15°C

For core identification, diameter tolerances and current ratings etc. see technical information section

#### Application

Used as signal and communication cables in radio, radar and information systems of marine vehicles. It's twisted pairs enables proper transmission of high frequency signals, while it's overall screen minimizes environmental electromagnetic interference.



Halogen Free



Low Smoke Density



Flame Retardant



Rated Voltage



Test Voltage



Working Temperature



Bending Radius



No Corrosivity

Cross Section (mm <sup>2</sup> )	Overall Diameter (mm)	Approximate Weight (kg / km)	Min. Bending Radius Fixed Installed (mm)	Max Resistance of Conductors at 20°C (ohm / km)	Current Carrying Capacity at 45°C (A)
1x2x0,5	5,7	42	35	40,4	11
2x2x0,5	7,9	68	48	40,4	9
4x2x0,5	9,3	105	56	40,4	6
7x2x0,5	10,9	150	66	40,4	5
10x2x0,5	14,1	220	85	40,4	5
12x2x0,5	14,5	244	87	40,4	5
14x2x0,5	15,2	274	92	40,4	4
16x2x0,5	16,1	315	97	40,4	4
18x2x0,5	17,1	345	103	40,4	4
24x2x0,5	20,1	450	121	40,4	4
37x2x0,5	23,1	640	139	40,4	3
1x2x0,75	6,5	55	39	26,0	13
2x2x0,75	9,4	90	57	26,0	11
4x2x0,75	10,9	140	66	26,0	8
7x2x0,75	13,1	210	79	26,0	7
10x2x0,75	16,9	310	102	26,0	6
12x2x0,75	17,5	350	105	26,0	6
14x2x0,75	18,4	395	111	26,0	5
16x2x0,75	19,6	450	118	26,0	5
18x2x0,75	20,6	496	124	26,0	5
24x2x0,75	24,2	648	146	26,0	5
37x2x0,75	28,1	952	169	26,0	4
1x2x1	6,8	60	41	19,2	16
2x2x1	9,9	105	60	19,2	13
4x2x1	11,7	164	71	19,2	9
7x2x1	14,0	255	84	19,2	8
10x2x1	17,9	360	108	19,2	7
12x2x1	18,5	410	111	19,2	7
14x2x1	19,6	470	118	19,2	6
16x2x1	20,8	530	125	19,2	6
18x2x1	22,0	596	132	19,2	6
24x2x1	25,9	780	156	19,2	6
37x2x1	29,8	1132	179	19,2	5

Cross Section (mm <sup>2</sup> )	Overall Diameter (mm)	Approximate Weight (kg / km)	Min. Bending Radius Fixed Installed (mm)	Max Resistance of Conductors at 20°C (ohm / km)	Current Carrying Capacity at 45°C (A)
1x2x1,5	7,9	80	48	12,8	20
1x3x1,5	8,6	101	52	12,8	17
2x2x1,5	11,8	145	71	12,8	17
4x2x1,5	13,9	234	84	12,8	12
7x2x1,5	16,7	370	101	12,8	10
10x2x1,5	21,4	520	129	12,8	9
12x2x1,5	22,3	610	134	12,8	9
14x2x1,5	23,5	690	141	12,8	8
16x2x1,5	25,1	782	151	12,8	8
18x2x1,5	26,3	864	158	12,8	7
24x2x1,5	31,3	1150	188	12,8	7
37x2x1,5	36,2	1694	218	12,8	6
1x2x2,5	9,1	107	55	7,86	27
1x3x2,5	9,7	138	58	7,86	22





### CABLE STRUCTURE

<b>Conductor</b>	Electrolytic, stranded, annealed copper wire. IEC 60228 Class 2 (Class 5 and / or tinned on request)
<b>Insulation</b>	Cross linked polyethylene compound (XLPE). Each pair formed by white cores with black numbers.
<b>Separator</b>	Separating foil over each pair.
<b>Individual Screen</b>	Electrolytic, tinned, stranded, copper drain wire and aluminum tape screen over each pair.
<b>Separator</b>	Separating tape over each screen pair.
<b>Overall Screen</b>	Electrolytic, tinned, stranded, copper drain wire and aluminum tape screen.
<b>Separator (Optional)</b>	Overall separating foil above overall screen
<b>Outer sheath</b>	Halogen-free, flame retardant, UV resistant, polyolefin based compound (SHF1).
<b>Color</b>	Black or Grey.

### STANDARDS & MAIN CHARACTERISTICS

Construction	IEC 60092 / 376
Tests and Material	IEC 60092 / 350-360
Flame Retardant	IEC 60332 / 1, IEC 60332 / 3-22 Cat A
Halogen Content	IEC 60754 / 1-2
Smoke Emission	IEC 61034 / 1-2 (DIN EN 50268 / 1-2)
Ozone Resistance	IEC 60811 / 403
Working Temperature	-40°C / + 90°C
Min. Bending Radius (fixed)	6xD
Rated Voltage	150 / 250 V
Test Voltage	1,5 kV
UV and Sunlight Resistance	EN 50289-4-17 A&B, ISO 4892-2&3

Minimum recommended installation temperature -15°C

For core identification, diameter tolerances and current ratings etc. see technical information section

#### Application

Used as signal and communication cables in radio, radar and information systems of marine vehicles. It's twisted pairs enables proper transmission of high frequency signals, while it's overall screen minimizes environmental electromagnetic interference.



Halogen Free



Low Smoke Density



Flame Retardant



Rated Voltage



Test Voltage



Working Temperature



Bending Radius



No Corrosivity

Cross Section (mm <sup>2</sup> )	Overall Diameter (mm)	Approximate Weight (kg / km)	Min. Bending Radius Fixed Installed (mm)	Max Resistance of Conductors at 20°C (ohm / km)	Current Carrying Capacity at 45°C (A)
2x2x0,5	9,2	88	56	40,4	9
4x2x0,5	10,6	132	64	40,4	6
6x2x0,5	12,1	179	73	40,4	6
7x2x0,5	12,8	206	77	40,4	5
12x2x0,5	17,1	340	103	40,4	5
15x2x0,5	17,9	390	107	40,4	4
16x2x0,5	18,9	430	114	40,4	4
18x2x0,5	20,2	485	122	40,4	4
24x2x0,5	23,8	635	143	40,4	4
2x2x0,75	10,6	110	64	26,0	11
4x2x0,75	12,6	176	76	26,0	8
6x2x0,75	15,1	248	91	26,0	7
7x2x0,75	15,2	275	92	26,0	7
10x2x0,75	19,5	393	117	26,0	6
12x2x0,75	20,4	455	123	26,0	6
15x2x0,75	22,6	552	136	26,0	5
16x2x0,75	22,8	585	137	26,0	5
18x2x0,75	24,0	646	144	26,0	5
20x2x0,75	25,3	710	152	26,0	5
24x2x0,75	28,6	862	172	26,0	5
2x2x1	11,4	130	69	19,2	13
4x2x1	13,2	200	80	19,2	9
7x2x1	16,0	315	96	19,2	8
12x2x1	21,5	520	129	19,2	7
16x2x1	24,1	670	145	19,2	6
18x2x1	25,6	754	154	19,2	6
24x2x1	30,4	1005	183	19,2	6
2x2x1,5	13,4	164	81	12,8	17
4x2x1,5	15,9	272	96	12,8	12
6x2x1,5	19,4	395	116	12,8	11
7x2x1,5	19,4	440	117	12,8	10
8x2x1,5	22,0	508	132	12,8	10
10x2x1,5	25,1	629	151	12,8	9
12x2x1,5	26,1	730	157	12,8	9

Cross Section (mm <sup>2</sup> )	Overall Diameter (mm)	Approximate Weight (kg / km)	Min. Bending Radius Fixed Installed (mm)	Max Resistance of Conductors at 20°C (ohm / km)	Current Carrying Capacity at 45°C (A)
14x2x1,5	27,5	831	165	12,8	8
15x2x1,5	29,0	887	174	12,8	8
16x2x1,5	29,3	942	176	12,8	8
18x2x1,5	31,1	1060	187	12,8	7
20x2x1,5	32,8	1161	197	12,8	7
24x2x1,5	36,9	1405	222	12,8	7
2x2x2,5	15,3	223	92	7,86	22
7x2x2,5	22,0	610	132	7,86	13





### CABLE STRUCTURE

<b>Conductor</b>	Electrolytic, stranded, annealed copper wire IEC 60228 Class 2 (Class 5 and / or tinned on request)
<b>Fire Barrier</b>	Mica Tape
<b>Insulation</b>	Cross linked polyethylene compound (XLPE). Each pair formed by white cores with black numbers.
<b>Inner Covering</b>	Separating foil.
<b>Screen</b>	Electrolytic copper braided screen (Min. 90% coverage). (Tinned copper wire braid on request)
<b>Outer sheath</b>	Halogen-free, flame retardant, UV Resistant, polyolefin based compound (SHF 1).
<b>Color</b>	Orange or Green.

### STANDARDS & MAIN CHARACTERISTICS

Construction	IEC 60092 / 376
Tests and Material	IEC 60092 / 350-360
Flame Retardant	IEC 60332 / 1, IEC 60332 / 3-22 Cat A
Fire Resistance	IEC 60331 / 21, IEC 60331 / 1-2
Halogen Content	IEC 60754 / 1-2
Smoke Emission	IEC 61034 / 1-2 (DIN EN 50268 / 1-2)
Ozon Resistance	IEC 60811 / 403
Working Temperature	-40°C / + 90°C
Min. Bending Radius (fixed)	6xD
Rated Voltage	150 / 250 V
Test Voltage	1,5 kV
UV and Sunlight Resistance	EN 50289-4-17 A&B, ISO 4892-2&3

Minimum recommended installation temperature -15°C  
 For core identification, diameter tolerances and current ratings etc. see technical information section

#### Application

Used as control and signal cables in various electromechanical and electronic equipments of marine vehicles, in most areas & open deck in ships. Due to its' overall screen the electromagnetic interference is minimized.



Halogen Free



Low Smoke Density



Flame Retardant



Rated Voltage



Test Voltage



Working Temperature



Bending Radius



No Corrosivity

Cross Section (mm <sup>2</sup> )	Overall Diameter (mm)	Approximate Weight (kg / km)	Min. Bending Radius Fixed Installed (mm)	Max Resistance of Conductors at 20°C (ohm / km)	Current Carrying Capacity at 45°C (A)
1x2x0,5	7,2	70	44	40,4	11
1x4x0,5	8,1	95	49	40,4	9
2x2x0,5	10,2	120	62	40,4	9
4x2x0,5	11,9	175	72	40,4	6
5x2x0,5	12,9	202	78	40,4	6
7x2x0,5	14,5	280	87	40,4	5
8x2x0,5	15,6	310	94	40,4	5
10x2x0,5	18,3	390	110	40,4	5
12x2x0,5	18,8	424	113	40,4	5
14x2x0,5	19,9	480	120	40,4	4
16x2x0,5	21,0	530	126	40,4	4
18x2x0,5	22,2	585	134	40,4	4
19x2x0,5	22,2	605	134	40,4	4
20x2x0,5	23,2	630	140	40,4	4
24x2x0,5	23,6	705	142	40,4	4
37x2x0,5	29,6	1025	180	40,4	3
1x2x0,75	8,1	90	49	26,0	13
1x4x0,75	9,4	125	57	26,0	11
2x2x0,75	11,9	155	72	26,0	11
4x2x0,75	14,3	260	86	26,0	8
5x2x0,75	15,5	300	93	26,0	7
6x2x0,75	16,9	346	102	26,0	7
7x2x0,75	16,9	368	102	26,0	7
8x2x0,75	18,3	413	110	26,0	6
10x2x0,75	21,4	510	129	26,0	6
12x2x0,75	22,3	580	134	26,0	6
14x2x0,75	23,4	640	141	26,0	5
16x2x0,75	24,8	716	149	26,0	5
18x2x0,75	26,1	786	157	26,0	5
19x2x0,75	26,1	810	157	26,0	5
20x2x0,75	27,6	864	166	26,0	5
24x2x0,75	30,7	1020	185	26,0	5
37x2x0,75	35,8	1510	215	26,0	4

Cross Section (mm <sup>2</sup> )	Overall Diameter (mm)	Approximate Weight (kg / km)	Min. Bending Radius Fixed Installed (mm)	Max Resistance of Conductors at 20°C (ohm / km)	Current Carrying Capacity at 45°C (A)
1x2x1	8,5	96	51	19,2	16
1x4x1	9,7	136	59	19,2	13
2x2x1	12,2	170	74	19,2	13
4x2x1	14,7	280	89	19,2	9
5x2x1	16,0	325	96	19,2	9
6x2x1	17,4	380	105	19,2	8
7x2x1	17,4	405	105	19,2	8
8x2x1	18,8	452	113	19,2	8
10x2x1	22,3	572	134	19,2	7
12x2x1	23,0	638	138	19,2	7
14x2x1	24,1	710	145	19,2	6
16x2x1	25,6	795	154	19,2	6
18x2x1	26,9	870	162	19,2	6
19x2x1	26,9	900	162	19,2	6
20x2x1	28,5	960	171	19,2	6
24x2x1	28,9	1080	174	19,2	6
37x2x1	36,9	1682	222	19,2	5
1x2x1,5	9,5	120	57	12,8	20
1x4x1,5	10,9	174	66	12,8	17
2x2x1,5	14,4	246	87	12,8	17
4x2x1,5	16,8	364	101	12,8	12
5x2x1,5	18,4	430	111	12,8	11
6x2x1,5	20,1	490	121	12,8	10
7x2x1,5	20,1	540	121	12,8	10
8x2x1,5	21,7	600	131	12,8	9
10x2x1,5	25,7	765	155	12,8	9
12x2x1,5	26,5	850	159	12,8	9
14x2x1,5	28,1	965	169	12,8	8
16x2x1,5	29,6	1070	178	12,8	8
18x2x1,5	31,3	1185	188	12,8	7
19x2x1,5	31,3	1230	188	12,8	7
20x2x1,5	33,2	1312	200	12,8	7
24x2x1,5	33,7	1478	203	12,8	7
37x2x1,5	43,0	2290	258	12,8	6



IEC 60332-3 A 0187 M 2007

CANTEL 3

IEC 60092



### CABLE STRUCTURE

<b>Conductor</b>	Electrolytic, stranded, annealed copper wire. IEC 60228 Class 2 (Class 5 and / or tinned on request)
<b>Fire Barrier</b>	Mica tape
<b>Insulation</b>	Cross linked polyethylene compound (XLPE). Each pair formed by white cores with black numbers.
<b>Separator</b>	Separating tape over pairs.
<b>Individual Screen</b>	Electrolytic, tinned, stranded, copper drain wire and aluminum tape screen over each pair
<b>Inner Covering</b>	Separating foil.
<b>Overall Screen</b>	Electrolytic copper braided screen (Min. 90% coverage) (Tinned copper wire braid on request)
<b>Outer sheath</b>	Halogen-free, flame retardant, UV resistant polyolefin based compound (SHF 1).
<b>Color</b>	Orange or Green.

### STANDARDS & MAIN CHARACTERISTICS

Construction	IEC 60092 / 376
Tests and Material	IEC 60092 / 350-360
Flame Retardant	IEC 60332 / 1, IEC 60332 / 3-22 Cat A
Fire Resistance	IEC 60331 / 21, IEC 60331 / 1-2
Halogen Content	IEC 60754 / 1-2
Smoke Emission	IEC 61034 / 1-2 (DIN EN 50268 / 1-2)
Ozone Resistance	IEC 60811 / 403
Working Temperature	-40°C / + 90°C
Min. Bending Radius (fixed)	6xD
Rated Voltage	150 / 250 V
Test Voltage	1,5 kV
UV and Sunlight Resistance	EN 50289-4-17 A&B, ISO 4892-2&3

Minimum recommended installation temperature -15°C

For core identification, diameter tolerances and current ratings etc. see technical information section

#### Application

Used as signal and communication cables in radio, radar and information systems of marine vehicles. It's twisted pairs enables proper transmission of high frequency signals, while it's overall screen minimizes environmental electromagnetic interference.



Halogen Free



Low Smoke Density



Flame Retardant



Rated Voltage



Test Voltage



Working Temperature



Bending Radius



No Corrosivity

Cross Section (mm <sup>2</sup> )	Overall Diameter (mm)	Approximate Weight (kg / km)	Min. Bending Radius Fixed Installed (mm)	Max Resistance of Conductors at 20°C (ohm / km)	Current Carrying Capacity at 45°C (A)
2x2x0,5	11,7	156	71	40,4	9
4x2x0,5	14,1	258	85	40,4	6
7x2x0,5	16,7	370	101	40,4	5
12x2x0,5	21,7	564	131	40,4	5
16x2x0,5	24,1	700	145	40,4	4
18x2x0,5	25,5	780	155	40,4	4
24x2x0,5	27,4	950	165	40,4	4
2x2x0,75	13,0	182	78	26,0	11
4x2x0,75	15,6	305	94	26,0	8
7x2x0,75	18,6	440	112	26,0	7
12x2x0,75	24,8	706	149	26,0	6
16x2x0,75	28,2	890	170	26,0	5
18x2x0,75	29,6	975	178	26,0	5
24x2x0,75	34,9	1264	210	26,0	5
2x2x1	14,4	228	87	19,2	13
4x2x1	16,7	345	101	19,2	9
7x2x1	19,9	502	120	19,2	8
12x2x1	26,3	790	158	19,2	7
16x2x1	30,1	1010	181	19,2	6
18x2x1	31,7	1110	191	19,2	6
24x2x1	37,7	1530	227	19,2	6
2x2x1,5	16,2	294	98	12,8	17
4x2x1,5	18,9	435	114	12,8	12
7x2x1,5	22,9	655	138	12,8	10
12x2x1,5	31,1	1060	187	12,8	9
16x2x1,5	34,7	1330	209	12,8	8
18x2x1,5	37,1	1562	223	12,8	7
24x2x1,5	43,8	2040	263	12,8	7



## CABLE STRUCTURE

<b>Conductor</b>	Electrolytic, stranded, annealed copper wire IEC 60228 Class 2 (Class 5 and / or tinned on request)
<b>Fire Barrier</b>	Mica tape
<b>Insulation</b>	Cross linked polyethylene compound (XLPE). Each pair formed by white cores with black numbers.
<b>Inner Covering</b>	Separating foil.
<b>Screen</b>	Electrolytic, tinned, stranded, copper drain wire and aluminum tape overall screen.
<b>Separator (Optional)</b>	Separating foil above screen.
<b>Outer sheath</b>	Halogen-free, flame retardant, UV resistant, polyolefin based compound (SHF 1).
<b>Color</b>	Orange or Green.

## STANDARDS & MAIN CHARACTERISTICS

Construction	IEC 60092 / 376
Tests and Material	IEC 60092 / 350-360
Flame Retardant	IEC 60332 / 1, IEC 60332 / 3-22 Cat A
Fire Resistance	IEC 60331 / 21, IEC 60331 / 1-2
Halogen Content	IEC 60754 / 1-2
Smoke Emission	IEC 61034 / 1-2 (DIN EN 50268 / 1-2)
Ozone Resistance	IEC 60811 / 403
Working Temperature	-40°C / + 90°C
Min. Bending Radius (fixed)	6xD
Rated Voltage	150 / 250 V
Test Voltage	1,5 kV
UV and Sunlight Resistance	EN 50289-4-17 A&B, ISO 4892-2&3

Minimum recommended installation temperature -15°C

For core identification, diameter tolerances and current ratings etc. see technical information section

### Application

Used as signal and communication cables in radio, radar and information systems of marine vehicles. It's twisted pairs enables proper transmission of high frequency signals, while it's overall screen minimizes environmental electromagnetic interference.



Halogen Free



Low Smoke Density



Flame Retardant



Rated Voltage



Test Voltage



Working Temperature



Bending Radius



No Corrosivity

Cross Section (mm <sup>2</sup> )	Overall Diameter (mm)	Approximate Weight (kg / km)	Min. Bending Radius Fixed Installed (mm)	Max Resistance of Conductors at 20°C (ohm / km)	Current Carrying Capacity at 45°C (A)
1x2x0,5	6,6	50	40	40,4	11
2x2x0,5	9,6	85	58	40,4	9
4x2x0,5	11,3	130	68	40,4	6
7x2x0,5	13,3	190	80	40,4	5
10x2x0,5	17,3	276	104	40,4	5
12x2x0,5	17,8	310	107	40,4	5
14x2x0,5	18,7	350	113	40,4	4
16x2x0,5	20,0	400	120	40,4	4
18x2x0,5	21,0	440	126	40,4	4
24x2x0,5	22,6	555	136	40,4	4
37x2x0,5	28,6	832	172	40,4	3
1x2x0,75	7,5	60	45	26,0	13
2x2x0,75	11,3	115	68	26,0	11
4x2x0,75	13,1	170	79	26,0	8
7x2x0,75	15,7	260	95	26,0	7
10x2x0,75	20,4	380	123	26,0	6
12x2x0,75	21,1	430	127	26,0	6
14x2x0,75	22,4	494	135	26,0	5
16x2x0,75	23,6	550	142	26,0	5
18x2x0,75	25,1	620	151	26,0	5
24x2x0,75	29,5	810	178	26,0	5
37x2x0,75	34,2	1175	206	26,0	4
1x2x1	7,7	68	47	19,2	16
2x2x1	11,6	125	70	19,2	13
4x2x1	13,5	190	81	19,2	9
7x2x1	16,2	292	98	19,2	8
10x2x1	21,1	424	127	19,2	7
12x2x1	22,0	494	132	19,2	7
14x2x1	23,1	560	139	19,2	6
16x2x1	24,4	625	147	19,2	6
18x2x1	25,9	700	156	19,2	6
24x2x1	30,7	930	185	19,2	6
37x2x1	35,5	1355	213	19,2	5

Cross Section (mm <sup>2</sup> )	Overall Diameter (mm)	Approximate Weight (kg / km)	Min. Bending Radius Fixed Installed (mm)	Max Resistance of Conductors at 20°C (ohm / km)	Current Carrying Capacity at 45°C (A)
1x2x1,5	8,9	90	54	12,8	20
2x2x1,5	13,2	160	80	12,8	17
4x2x1,5	15,7	260	95	12,8	12
7x2x1,5	18,9	405	114	12,8	10
10x2x1,5	24,7	596	149	12,8	9
12x2x1,5	25,6	682	154	12,8	9
14x2x1,5	26,9	775	162	12,8	8
16x2x1,5	28,7	880	173	12,8	8
18x2x1,5	30,4	985	183	12,8	7
24x2x1,5	36,0	1310	216	12,8	7
37x2x1,5	41,7	1910	251	12,8	6





### CABLE STRUCTURE

<b>Conductor</b>	Electrolytic, stranded, annealed copper wire. IEC 60228 Class 2 (Class 5 and / or tinned on request)
<b>Fire Barrier</b>	Mica tape
<b>Insulation</b>	Cross linked polyethylene compound (XLPE). Each pair fomed by white cores with black numbers.
<b>Separator</b>	Separating foil over each pair.
<b>Individual Screen</b>	Electrolytic, tinned, stranded, copper drain wire and aluminum tape screen over each pair.
<b>Separator</b>	Separating tape over each screend pair.
<b>Overall Screen</b>	Electrolytic, tinned, stranded, copper drain wire and aluminum tape screen.
<b>Separator (Optional)</b>	Overall separating foil above overall screen
<b>Outer sheath</b>	Halogen-free, flame retardant, UV resistant, polyolefin based compound (SHF 1).
<b>Color</b>	Orange or Green.

### STANDARDS & MAIN CHARACTERISTICS

Construction	IEC 60092 / 376
Tests and Material	IEC 60092 / 350-360
Flame Retardant	IEC 60332 / 1, IEC 60332 / 3-22 Cat A
Fire Resistance	IEC 60331 / 21, IEC 60331 / 1-2
Halogen Content	IEC 60754 / 1-2
Smoke Emission	IEC 61034 / 1-2 (DIN EN 50268 / 1-2)
Ozone Resistance	IEC 60811 / 403
Working Temperature	-40°C / +90°C
Min. Bending Radius (fixed)	6xD
Rated Voltage	150 / 250 V
Test Voltage	1,5 kv
UV and Sunlight Resistance	EN 50289-4-17 A&B, ISO 4892-2&3

### Application

Used as signal and communication cables in radio, radar and information systems of marine vehicles. It's twisted pairs enables proper transmission of high frequency signals, while it's overall screen minimizes environmental electromagnetic interference.



Cold Resistant



Tear Resistant



Uv Resistant



Rated Voltage



Test Voltage



Working Temperature



Bending Radius



No Corrosivity

Cross Section (mm <sup>2</sup> )	Overall Diameter (mm)	Approximate Weight (kg / km)	Min. Bending Radius Fixed Installed (mm)	Max Resistance of Conductors at 20°C (ohm / km)	Current Carrying Capacity at 45°C (A)
2x2x0,5	11,2	112	68	40,4	9
4x2x0,5	13,0	168	78	40,4	6
7x2x0,5	15,6	258	94	40,4	5
12x2x0,5	21,0	425	126	40,4	5
16x2x0,5	23,5	545	141	40,4	4
18x2x0,5	24,9	610	150	40,4	4
24x2x0,5	29,3	800	176	40,4	4
2x2x0,75	12,5	135	75	26,0	11
4x2x0,75	14,7	210	88	26,0	8
7x2x0,75	17,8	300	107	26,0	7
12x2x0,75	23,8	484	143	26,0	6
16x2x0,75	26,7	690	160	26,0	5
18x2x0,75	28,3	775	170	26,0	5
24x2x0,75	33,6	1028	202	26,0	5
2x2x1	13,2	148	79	19,2	13
4x2x1	15,6	236	94	19,2	9
7x2x1	18,9	370	113	19,2	8
12x2x1	25,6	625	154	19,2	7
16x2x1	28,6	800	172	19,2	6
18x2x1	30,4	896	182	19,2	6
24x2x1	36,0	1190	216	19,2	6
2x2x1,5	15,3	195	92	12,8	17
4x2x1,5	18,1	318	109	12,8	12
7x2x1,5	22,0	510	132	12,8	10
12x2x1,5	29,6	840	178	12,8	9
16x2x1,5	33,4	1096	201	12,8	8
18x2x1,5	35,2	1210	211	12,8	7
24x2x1,5	41,9	1630	252	12,8	7



## CABLE STRUCTURE

<b>Conductor</b>	Electrolytic annealed, class 5 stranded plain copper wires (tinned conductor on request)
<b>Separator</b>	A suitable tape may be applied over the conductor
<b>Insulation</b>	EI4 Type rubber (EPR) compound
<b>Core Identification</b>	Acc. to HD 308
<b>Inner Sheath</b>	EM2 or EM3 type elastomer compound (if outer sheath thickness is greater than 2.4 mm)
<b>Outer Sheath</b>	EM2 Type elastomer compound
<b>Color</b>	Black (other colors on request)

## STANDARDS & MAIN CHARACTERISTICS

Construction	EN 50525-2-21, DIN VDE 0282-4, BS 6500 BS 7919, IEC 60245-4
General Requirements	EN 50525-1, HD 22.1, DN VDE 0282-1, IEC 60245-1
Guide to Use	HD 516, DIN VDE 0298-300
Electrical Tests	EN 50395, IEC 60245-2
Non - Electrical Tests	EN 50396, IEC 60245-2
Conductor Resistance	EN / IEC 60228, HD 383, DIN VDE 0295, BS 6360
Working Temperature	
In Mobile Use	-25°C / +60°C
in Fixed Use	-35°C / +90°C
Conductor Short - Circuit	Max. 200°C
Temp. Temp. on Cable Surface	Max. +50°C
Min. Installation Temp.	-25°C
Min. Bending Radius	EN 50565-1 Table. 3
Max. Tensile Load	15 N / mm <sup>2</sup>
Current Carrying Capacities	IEC 60364-5-52, VDE 0298-4, EN 50565-1
Flame Retardant	EN 60332-1-2, DIN VDE 0482-332-1-2 EN
Oil Resistant	50363-2-1, IEC 60811-404
UV and Sunlight Resistance	EN 50289-4-17 A&B, ISO 4892-2&3

It's allowed up to 1.000 V AC or DC using for fixed and protected installations.

### Application

This flexible cable is suitable to use as power supply and control cable in fixed or mobile connections and equipments like heavy machineries, switch boards, industrial equipments, power sources etc.



Uv  
Resistant



Rated  
Voltage



Working  
Temperature



Bending  
Radius



No  
Corrosivity

Cross Section (mm <sup>2</sup> )	Nominal Overall Diameter (mm)	Approximate Weight (kg / km)	Min. Bending Radius Fixed Installed (mm)	Max Resistance of Conductors at 20°C (ohm / km)	Current Carrying Capacity for flexing usage (A)	Current Carrying Capacity for fixed usage (A)
1x1,5	6,00	50	18	13,3	16,5	24
1x2,5	6,40	63	19	7,98	22	33
1x4	7,30	85	22	4,95	30	45
1x6	8,10	111	24	3,3	38	58
1x10	10,20	179	31	1,91	53	80
1x16	11,00	238	33	1,21	71	107
1x25	13,80	365	55	0,780	94	135
1x35	15,30	475	61	0,554	117	169
1x50	17,80	657	71	0,386	148	207
1x70	19,40	864	78	0,272	185	268
1x95	22,10	1118	88	0,206	222	328
1x120	24,40	1404	98	0,161	260	383
1x150	16,60	1698	66	0,129	300	444
1x185	29,70	2100	119	0,106	341	510
1x240	32,60	2396	130	0,0801	407	607
1x300	35,60	3256	142	0,0641	468	703
1x400	40,90	4377	164	0,0486	553	823
1x500	45,60	5632	182	0,0384	634	946
1x630	49,30	6975	197	0,0287	742	10883
2x1	8,40	94	25	19,5	15	19
2x1,5	9,30	117	28	13,3	18,5	26
2x2,5	10,60	160	32	7,98	25	36
2x4	12,20	221	49	4,95	34	49
2x6	13,60	288	54	3,30	43	63
2x10	19,20	555	77	1,91	60	86
2x16	21,00	717	84	1,21	79	115
2x25	26,70	1124	107	0,780	105	149
2x35	29,40	1421	118	0,554	129	185
2x50	34,40	1968	138	0,386	162	225
2x70	38,30	2564	153	0,272	202	289
2x95	43,70	3330	175	0,206	240	352

Cross Section (mm <sup>2</sup> )	Nominal Overall Diameter (mm)	Approximate Weight (kg / km)	Min. Bending Radius Fixed Installed (mm)	Max Resistance of Conductors at 20°C (ohm / km)	Current Carrying Capacity for flexing usage (A)	Current Carrying Capacity for fixed usage (A)
3x1	9,10	114	27	19,5	12,5	17
3x1,5	9,90	140	30	13,3	15,5	23
3x2,5	11,40	196	34	7,98	21	32
3x4	13,10	273	52	4,95	29	42
3x6	14,60	358	58	3,30	36	54
3x10	20,60	682	82	1,91	51	75
3x16	22,50	892	90	1,21	67	100
3x25	28,60	1390	114	0,780	89	127
3x35	31,70	1789	127	0,554	110	158
3x50	37,00	2474	148	0,386	138	192
3x70	40,90	3231	164	0,272	172	246
3x95	46,90	4220	188	0,206	204	298
3x120	51,60	5248	206	0,161	238	346
3x150	56,20	6319	225	0,129	273	399
3x185	62,30	7806	249	0,106	309	456
3x240	69,50	9963	278	0,0801	365	538
4x1	10,10	143	30	19,5	13	17
4x1,5	11,00	175	33	13,3	16	23
4x2,5	12,60	244	50	7,98	22	32
4x4	14,50	342	58	4,95	30	42
4x6	16,30	456	65	3,3	37	54
4x10	22,60	845	90	1,91	52	75
4x16	24,70	1114	99	1,21	69	100
4x25	31,80	1760	127	0,780	92	127
4x35	35,20	2265	141	0,554	114	158
4x50	41,10	3136	164	0,386	143	192
4x70	45,00	4098	180	0,272	178	246
4x95	52,00	5393	208	0,206	210	298
4x120	56,80	6657	227	0,161	246	346
4x150	62,20	8067	249	0,129	282	399
4x185	69,70	10030	279	0,106	319	456
4x240	77,60	12786	310	0,0801	377	538

Cross Section (mm <sup>2</sup> )	Nominal Overall Diameter (mm)	Approximate Weight (kg / km)	Min. Bending Radius Fixed Installed (mm)	Max Resistance of Conductors at 20°C (ohm / km)	Current Carrying Capacity for flexing usage (A)	Current Carrying Capacity for fixed usage (A)
5x1	11,10	170	33	19,5	13,5	17
5x1,5	12,10	208	48	13,3	16,5	23
5x2,5	13,80	290	55	7,98	23	32
5x4	16,10	415	64	4,95	30	42
5x6	18,10	554	72	3,30	38	54
5x10	24,90	1033	100	1,91	54	75
5x16	27,40	1377	110	1,21	71	100
5x25	35,40	2183	142	0,78	94	127
5x35	38,90	2788	156	0,554	117	158
5x50	45,80	3902	183	0,386	148	192
5x70	50,20	5113	201	0,272	185	246
7x1,5	15,40	337	62	13,3	10	16
7x2,5	17,50	463	70	7,98	14	22
12x1,5	18,70	486	75	13,3	9	13
12x2,5	21,20	669	85	7,98	11	18
18x1,5	22,00	690	88	13,3	7	12
18x2,5	25,00	964	100	7,98	9	16
24x1,5	25,70	894	103	13,3	6	9
24x2,5	29,40	1263	118	7,98	8,5	13
36x1,5	29,40	1245	118	13,3	6	8
36x2,5	33,80	1781	135	7,98	8	11

**Notes for current carrying capacities:**

Current carrying capacities are according to in open air, with adequate ventilation and ambient temperature of 30 °C

**For fixed installation :**

Based on IEC 60364-5-52 : 2009 Table B.52.1 and Table B.52.12

Referred to

- Reference installation method F for Single cores and three loaded cores in trefoil installation.
- Reference installation method E for Multi cores for 2 core cables; two cores loaded and for 3-4-5 core cables; three cores loaded
- Reference installation method E for Multi cores for 6 cores and above; All cores loaded except green /yellow (earth) core
- Correction factors for ambient temperature according to Table B.52.14
- The current ratings are based on conductor operating temperature of 90 °C

**For mobile flexing installation :**

Based on EN 50565-1:2014 Table C.2, C.3 and VDE 0298-4 Table 13

Referred to

- Single cores are bunched. (installed as 3 cables in trefoil)
- The current ratings are based on conductor operating temperature of 60 °C
- For 2 core cables, 2 cores are loaded.
- For 3,4 and 5 core cables, 3 cores are loaded.
- For Multi core cables has 6 cores and above, all cores loaded except green/yellow (earth) core
- For current rating derating factors of Multi core cables according to VDE 0298-4 Table 26
- Correction factors for ambient temperature according to VDE 0298-4 Table 17 and EN 50565-1 Table C.3

**Temperature correction factors**

Ambient temperature °C	30	35	40	45	50	55
Correction factor for fixed installation	1,00	0,96	0,91	0,87	0,82	0,76
Correction factor for mobile installation	1,00	0,91	0,82	0,71	0,58	0,41





# TECHNICAL DATA

# TECHNICAL DATA

## MARINE CABLES STANDARDS

**IEC 60092-350:** Shipboard power cables - General construction and test requirements

**IEC 60092-352:** Electrical installation in ships - Choice and installation of electrical cables.

**IEC 60092-353:** Single and multicore non-radial field. Power cables with extruded solid insulation for rated voltages 1 kV and 3 kV

**IEC 60092-354:** Single and three-core power cables with extruded solid insulation for rated voltages 6 kV up to 30 kV.

**IEC 60092-360:** Insulating and sheathing materials for shipboard and offshore units, power, control, instrumentation and telecommunication cables.

**IEC 60092-376:** Cables for control and instrumentation circuits 150/250 V (300 V).

**IEC 60228:** Conductors of insulated cables.

**IEC 60287:** (all parts), Electric cables - Calculation of the current rating.

**IEC 60331-21:** Test for electric cables under fire conditions – Circuit integrity – Part 21 Procedures and requirements – Cables of rated voltage up to and including 0,6/1kV

**IEC 60331-31:** Tests for electric cables under fire conditions - Circuit integrity - Part 31: Procedures and requirements for fire with shock - Cables of rated voltage up to and including 0,6/1,0 kV

**IEC 60331-1:** Test method for fire with shock at a temperature of at least 830°C for cables of rated voltage up to and including 0,6/1 kV and with an overall diameter exceeding 20mm.

**IEC 60331-2:** Test method for fire with shock at a temperature of at least 830°C for cables of rated voltage up to and including 0,6/1 kV and with an overall diameter not exceeding 20mm.

**IEC 60332-1-2:** Test for vertical flame propagation for single insulated wire or cable.

**IEC 60332-3-22:** Test for vertical flame spread of vertically - mouted bunched wires or cables - Category A

**IEC 60754-1:** Test on gases evolved during combustion of materials from cables. Part 1: Determination of the halogen acid gas content.

**IEC 60754-2:** Test on gases evolved during combustion of materials from cables. Part 2: Determination of acidity (by pH measurement) and conductivity.

**IEC 60811:** Common test methods for insulating and sheathing materials of electric cables.

**IEC 61034-1:** Measurement of smoke density of cables burning under defined conditions - Part 1: Test apparatus.

**IEC 61034-2:** Measurement of smoke density of cables burning under defined conditions - Part 2: Test procedure and requirements.

**BS-8491:** This test serves to verify the integrity of cables (diameter >20mm) while exposed to fire, mechanical shock and water spray. A sample of cable is held on a flame at a temperature of roughly 830°C, for a minimum of 120 minutes. The sample is also subjected to a mechanical shock, directly on the cable, every 10 minutes. Lastly, 5 minutes before the end of the test, the cable is sprayed by a strong jet of water for a period of 5 seconds, at intervals of 60 seconds.

**EN 50200 Annex E:** This test serves to verify circuit integrity of cables (diameter ≤20mm) while exposed to fire, mechanical shock and water spray. The cable is exposed to a flame 830°C, mechanical shocks for 15 minutes and an additional 15 minutes to flame, mechanical shocks and water spray.

# TECHNICAL DATA

## GENERAL INFORMATION ABOUT MARINE CABLES

Cables constructed in accordance with IEC 60092-350, IEC 60092-353, IEC 60092-354 and IEC 60092-376 are recommended for use on board ships. Cables (and their terminations) for use in special applications which are constructed in accordance with IEC 60702-1 and IEC 60702-2 are also acceptable provided that due consideration has been given to their intended application and use in a marine environment.

These cables are manufactured and tested in accordance to the standards being used for shipbuilding and repairing of ships and delivered to the end users together with the approvals of the requested classification societies.

### Construction

**Conductor:** Conductors of marine cables are in accordance with the specifications defined in standard IEC 60228.

**Insulation:** For the insulation of marine cables, materials like SIR, HEPR, XLPE, HFX, HF90 and PVC are used according to related IEC construction standard.

**Screening:** One of the preferable ways to minimize either the effects of external electromagnetic fields or to prevent the cables creating electromagnetic fields is to apply screening to the cables. By earthing this screen, these effects are minimized and the screen strengthens the structure of the cable as well. In marine cables screening is made by metal wire braiding (mostly copper) or using metal tapes or aluminium foil in touch with drain wire.

**Sheathing:** For the sheathing of marine cables, materials like PVC (ST2), SHF1, SHF 2, Chloroprene are used according to related construction standard(s). Our SHF 1 sheathing compound is halogen free, flame retardant, low smoke and has very good abrasion resistance, good mechanical properties, low moisture absorption and high resistance to most of the chemicals.

**Flame retardance:** Flame retardant cables must be self-extinguishing when the source of flames dies out. The cables are tested according to IEC 60332-3-Cat A. Single, earth and bonding wires shall withstand the test specified in IEC 60332-1.

**Fire resistance:** During a fire it is vital that emergency circuits must continue to function. This could be communication circuits, emergency lights, alarms and fire pumps, etc. Fire resistant cables are tested in accordance with IEC 60331-21 and 31.

**Content of halogen:** Halogen-free cables will not cause corrosion to metals. When halogen - containing cables burn, the gases generated in combustion of the sheathing and insulation may cause corrosion. The secondary effects after a fire are often many times larger than the damages caused by the fire itself. The cables are tested to IEC 60754-1,2. Maximum content of halogen = 5 mg/g.

**Smoke Emission:** Smoke evolution has major significance in situations where escape routes are limited in case of fire. During the fire the light transmission is recommended to have a minimum value of 60% when tested in accordance with IEC 61034-2

**Oil resistance:** Although the cables with thermoplastic sheath material there are no requirements for oil resistance properties according to IEC 60092-360 our SHF 1 sheathing meets the criteria according to IEC 60811-2-1 for oil resistance to ASTM No.2 oil, 4 hours, 70 °C and our SHF2 sheathing meets oil resistivity in IRM oil no. 902 at 100°C for 24 hours.

**UV resistance:** Our halogen free sheathed marine cables have been tested and pass the requirements for UV resistivity and meet the criteria written in UL 1581 and ISO 4892-2

**Mud resistance:** In accordance with NEK 606 the mud resistant cables shall have a sheath (SHF Mud) that complies with the requirements in IEC 60092-360 for SHF2.

### Rated Voltage

The rated voltages of cables are expressed as  $U_0/U(U_m)$  where

- $U$  the rated voltage between the conductor and earth, or between the conductor and the metal screen
- $U$  the rated voltage between the conductors
- $U_m$  the highest system voltage

**Installation Temperature:** The minimum installation temperature for thermoplastic sheathed cables is -15°C.

**Maximum pulling tension:** 50 N x total cross-section of conductors.

# TECHNICAL DATA

## CODING OF ÜNTEL MARINE CABLES

**M 2X C H- FFR**

**1 2 3 4 5**

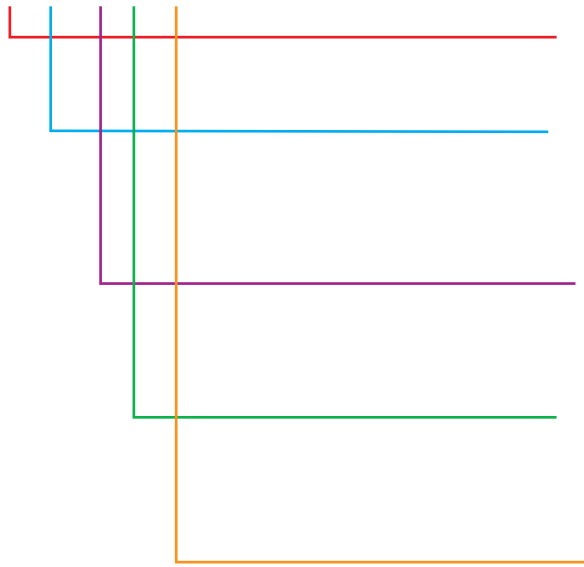

CODE	DESCRIPTION
<b>1</b>	<b>M</b> MARINE POWERCABLE <b>FM</b> MARINE TELECOMMUNICATION CABLE
<b>2</b>	<b>G</b> HEPR INSULATION <b>2X</b> XLPE INSULATION <b>Y</b> FLAME RETARDANT PVC INSULATION
<b>3</b>	<b>C</b> OVERALL COPPER BRAIDING SCREEN <b>CC</b> INDIVIDUAL AND OVERALL COPPER BRAIDING SCREEN <b>A</b> OVERALL ALUMINIUM TAPE SCREEN <b>AA</b> INDIVIDUAL AND OVERALL ALL TAPE SCREEN <b>S</b> STEEL WIRE BRAIDED SHIELD
<b>4</b>	<b>G</b> CHLOROPRENE OUTER SHEATH <b>Y</b> FLAME RETARDANT PVC (ST2) OUTER SHEATH <b>H</b> HALOGEN-FREE SHF1 OUTER SHEATH
<b>5</b>	<b>EMC</b> ENHANCED EMC PROTECTION <b>FFR</b> FIRE RESISTANT <b>FI</b> WITH INNER SHEATH <b>NOFI</b> WITH SEPARATING FOIL

## CORE IDENTIFICATION ACCORDING TO HD 308.S2

### 0,6/1 kv Power and Control Cables

N. of cores	Cores Colour					
1x...	-	-	-	Black	-	-
2x...	-	Blue	Brown	-	-	-
3G...	Green/Yellow	Blue	Brown	-	-	-
3x...	-	Brown	Black	Grey	-	-
4G...	Green/Yellow	Brown	Black	Grey	-	-
4x...	-	Blue	Brown	Black	Grey	-
5G...	Green/Yellow	Blue	Brown	Black	Grey	-
5x...	-	Blue	Brown	Black	Grey	Black
>5G... or > 5x...	White with black printed numbers, with or without Green/Yellow					

### 150/250 V Instrumentation Cables

N. of cores	Cores Colour
Pairs on triples	White color black numbered on each core ( eg 1,2 - 3,4 - 5,6)

### 3,6 up to 12/20kV Medium Voltage Cables

1x...: Natural colour of the compound  
3x...: Natural colour of the compound + numbered tape(s) or coloured or thread

# TECHNICAL DATA

## BENDING RADIUS

The internal bending radius for the installation of cables shall be as recommended by the manufacturer according to the type of cable chosen and shall not be less than the values given below tables

### Bending radii for cables rated up to 1,8 / 3kV

Cable construction		Overall diameter of cable (D)	Minimum internal radius of bend
Insulation	Covering		
Thermoplastic or thermosetting with circular copper conductors	Unarmoured	≤25 mm	4 D <sup>a</sup>
	or unbraided	≤25 mm	6 D
	Metal braid screened or armoured	Any	6 D
	Metal wire armoured	Any	6 D
	Metal tape armoured or metal - sheathed	Any	6 D
	composite polyester / metal laminate tape screened units or collective tape screening	Any	8 D
Mineral	Hard metal sheathed	Any	6 D

<sup>a</sup> 6D for defined circuit integrity

### Bending radii for cables rated at 3,6 /6,0 (7,2) kV and above

Cable construction	Overall diameter of cable (D)	Minimum internal radius of bend
Single Core Cable	Any	12 D
3 -Core Cables	Any	9 D

### TOLERANCE OUTER DIAMETER OF THE LOW VOLTAGE MARINE CABLES (\*)

Nominal Outer Diameter (mm)	Tolerance (+/- mm)
1 - 10	0.5
10.1 - 20	1.0
20.1 - 30	1.5
30.1 - 40	2.0
40.1 - 50	2.5
50.1 - 60	3.0
60.1 - 70	3.5
70.1 - 80	4.0

(\*) Not applicable to MV cables and sector shaped cables. For OD tolerances of these cables, refer to their own catalogue page

# TECHNICAL DATA

## PERMISSIBLE CURRENT CARRING CAPACITIES

Permissible current carrying capacities are stated by the rules of the vessel approval authority and in line with IEC 60092-352 and IEC 61892-4 standards.

These values are applicable for DC and AC with a nominal frequency of 50 Hz or 60Hz.

The current to be carried by any conductor for sustained periods during normal operation shall be such that the appropriate conductor temperature limit is not exceeded.

This catalogue gives only an extract of IEC 60092-352 standard that selected 2 methods for the determination of current carrying capacities for continuous service.

Below methods are derived from experimental data and from IEC 60287 (Electric cables - Calculation of current rating.)

**Annex A:** a method for determination of current carrying capacities based upon those that have been accepted and established in other applicas of cable use. This method allows for greater choice of use in different installation configurations. The basis of the determination is on the following formula:

Where 
$$I = A \times S^m - B \times S^n$$

**I** is the current carrying capacity (A);

**S** is the nominal cross-sectional area of conductor (mm<sup>2</sup>);

**A** and **B** are coefficients,  
**m** and **n** are exponents according to cable type and method of installation.

**Annex B:** a method for determination of current carrying capacities as given in the second edition (1997) of IEC 60092-352. It is recommended that they are only used for refurbishment of ships or in conjunction with other guidance information.

The formula on which they are based is:

$$I = \alpha \cdot A^{0,625}$$

Where

**I** is the current carrying capacity (A);

**A** is the nominal cross-sectional area of conductor (mm<sup>2</sup>);

$\alpha$  is a coefficient related to the maximum permissible service temperature of the conductor.

where  $\alpha$  is a coefficient related to the maximum permissible service temperature of the conductor as follows:

Maximum permissible temperature of the conductor		60 °C	70 °C	85 °C	90 °C	95 °C
Values of $\alpha$ for nominal Cross-sectional area	$\geq 2,5 \text{ mm}^2$	9,5	12	16	17	18
	$< 2,5 \text{ mm}^2$	8	11,5	16	18	20

The selection of the method applicable to any particular installation is the responsibility of the appropriate approval authority or governing regulation.

## Corection factors for cable grouping - IEC 60092-352

The current rating values may be considered applicable, without correction factor, for cables bunched together on cable trays, in cable conduit, pipe or trunking, unless more than 6 cables, which may be expected to operate simultaneously at their full rated current, are laid together in a cable bunch in such a way that there is an absence of free air circulation around them. In this case, a correction factor of 0,85 should be applied on current rating value.

# TECHNICAL DATA

## CURRENT CARRYING CAPACITIES

Current Ratings in accordance with IEC 60092-352 based on ambient air temperature of 45°C and a conductor temperature of the maximum rated temperature of the 90°C insulation.

For more than 4-cores, the current ratings are given by the following formula;

$I_1$  = Current rating for 1-core

$N$  = Number for cores

$$I_N = \frac{I_1}{\sqrt[3]{N}}$$

### For class 2 conductor cables

Size	N	1	2	3	4	5	7	10	12	14	16	19	24	27	37
	Factor, n	1	0,85	0,7	0,7	0,58	0,52	0,46	0,44	0,41	0,40	0,37	0,35	0,33	0,30
1,0 mm <sup>2</sup>	18	15	13	13	10	9	8	8	7	7	7	6	6	5	
1,5 mm <sup>2</sup>	23	20	16	16	13	12	11	10	9	9	9	8	7	7	
2,5 mm <sup>2</sup>	30	26	21	21	17	16	14	13	12	12	11	11	10	9	
4 mm <sup>2</sup>	40	34	28	28	23										
6 mm <sup>2</sup>	52	44	36	36	30										
10 mm <sup>2</sup>	72	61	50	50	42										
16 mm <sup>2</sup>	96	82	67	67	56										
25 mm <sup>2</sup>	127	108	89	89	74										
35 mm <sup>2</sup>	157	133	110	110	91										
50 mm <sup>2</sup>	196	167	137	137											
70 mm <sup>2</sup>	242	206	169	169											
95 mm <sup>2</sup>	293	249	205	205											
120 mm <sup>2</sup>	339	288	237	237											
150 mm <sup>2</sup>	389	331	272	272											
185 mm <sup>2</sup>	444	377	311	311											
240 mm <sup>2</sup>	522	444	365	365											
300 mm <sup>2</sup>	601	511	421	421											

### For class 5 conductor cables

Size	N	1	2	3	4	5	7	10	12	14	16	19	24	27	37
	Factor, n	1	0,85	0,7	0,7	0,58	0,52	0,46	0,44	0,41	0,40	0,37	0,35	0,33	0,30
1,0 mm <sup>2</sup>	16	14	12	12	10	9	8	7	7	6	6	6	5	5	
1,5 mm <sup>2</sup>	21	18	15	15	13	11	10	9	9	8	8	7	7	6	
2,5 mm <sup>2</sup>	29	25	21	21	17	15	13	13	12	12	11	10	9	9	
4 mm <sup>2</sup>	39	33	28	28	23										
6 mm <sup>2</sup>	50	43	35	35	29										
10 mm <sup>2</sup>	71	60	50	50	42										
16 mm <sup>2</sup>	93	79	66	66	54										
25 mm <sup>2</sup>	122	104	86	86	71										
35 mm <sup>2</sup>	152	129	107	107	89										
50 mm <sup>2</sup>	195	166	137	137											
70 mm <sup>2</sup>	240	204	168	168											
95 mm <sup>2</sup>	286	243	201	201											
120 mm <sup>2</sup>	332	282	233	233											
150 mm <sup>2</sup>	382	324	268	268											
185 mm <sup>2</sup>	432	367	301	301											
240 mm <sup>2</sup>	508	432	356	356											
300 mm <sup>2</sup>	590	502	413	413											

### Correction Factor for Various Ambient Air Temperatures

Ambient Temperature	35° C	40° C	45° C	50° C	55° C	60° C	65° C	70° C	75° C	80° C	85° C
Multiply Factor	1.10	1.05	1.00	0.94	0.88	0.82	0.74	0.67	0.58	0.47	-

# TECHNICAL DATA

Current carrying capacities in amperes  
Copper conductors temperature: 90 °C and reference ambient air temperature: 45 °C

Nominal cross-sectional area of conductor mm <sup>2</sup>	Installation Method													
	Method B1 Insulated conductors or single core cables in conduit on a bulkhead		Method B2 Multi-core cable in conduit on a bulkhead		Method C Multi-core cables on a bulkhead		Method E Multi-core cables in free air		Method F Single core cables, touching in free air		Method G Single core cables, spaced in free air			
	Two conductors	Three conductors	Two conductors	Three conductors	Two conductors	Three conductors	Two conductors	Three conductors	Two conductors	Three conductors	Two conductors	Three conductors	Horizontal	Vertical
1,5	20	17,5	19	17	21	19	23	20	140	117	123	158	140	
2,5	27	24	26	23	29	26	31	28	174	147	153	197	175	
4	37	32	35	30	39	35	43	37	211	180	188	239	214	
6	47	42	44	38	50	45	55	47	270	233	243	307	277	
10	65	57	60	52	70	62	75	65	328	285	298	374	338	
16	87	77	79	70	93	84	100	87	380	333	348	435	395	
25	116	102	104	91	120	104	130	110	438	386	404	502	458	
35	143	125	127	111	149	128	161	137	500	444	464	575	526	
50	172	152	152	134	182	156	196	167	591	528	552	679	626	
70	220	193	192	169	234	199	251	214	681	612	640	785	725	
95	266	234	231	203	285	242	306	259	818	716	755	944	877	
120	308	271	265	233	332	280	357	301	942	823	868	1 090	1 017	
150					384	323	412	347	1 091	947	1 001	1 265	1 185	
185					440	369	472	397						
240					521	435	558	468						
300					603	501	645	540						
400														
500														
630														

# TECHNICAL DATA

## SHORT CIRCUIT CURRENT RATINGS

The following short current ratings are for cables normally operating at a maximum conductor temperature of 90 °C

The theoretical temperature that arises in the conductor during a short circuit, which is used as a basis of the calculation, is 250 °C in accordance with IEC 60724.

EPR and XLPE insulation are capable of withstanding of short term temperature up to 250 °C

The short circuit current ratings for copper conductors given in the table are values for one second for other duration the current may be calculated from the following formula ;

$$I_k = 226 \times \frac{S}{\sqrt{t}} \times \sqrt{\ln \frac{234+T_k}{234+T_b}}$$

$I_k$  = Short Circuit Current (A)

$S$  = Cross Section (mm<sup>2</sup>)

$t$  = Duration of the Short Circuit (s)

$T_k$  = Max. Rated Conductor Temp. (°C) at Short Circuit

$T_b$  = Max. Conductor Temp.(°C)

Cross-section mm <sup>2</sup>	Short Circuit Current A(1s)
1	142
1.5	213
2.5	358
4	572
6	589
10	1,430
16	2,280
25	3,570
35	5,005
50	7,150
70	10,016
95	13,593
120	17,170
150	21,462
185	26,468
240	34,338
300	42,922

## REACTANCE - INDUCTANCE AND IMPEDANCE

The reactance of a cable operating in a A.C. system depends on the axial spacing between conductors. The values specified in cable construction details are for cables with circular conductors. The value for a sector-shaped conductor should be taken as 90% of the calculated value.

**Inductance** for 2-, 3- and 4- cores cables is given by the formula;

$$L = 0,2 \times \left( \ln \left( \frac{2a}{d} \right) + 0,25 \right) \times 10^{-6}$$

$L$  = Induction in H/m and phase,

$d$  = Conductor diameter in mm.

$a$  = Axial space between conductors in mm.

**Reactance** for 2-, 3- and 4- core cables is given by the formula;

$$X = 2 \times \pi \times f \times L \times l$$

$X$  = Reactance in ohm pr. Phase,

$l$  = Conductor length in meter.

$f$  = Frequency in Hz,

$L$  = Inductor in H/m and phase

# TECHNICAL DATA

**Impedance** for 2-, 3 and 4-core cables is given by the formula;

$$Z = \sqrt{R^2 + X^2}$$

**Z** = Impedance in ohm pr. phase,

**X** = Reactance in ohm pr. phase.

**R** = Resistance at operating temperature in ohm pr. phase,

## CONSTRUCTION AND RESISTANCE OF CONDUCTOR

Resistance Formula;

$$R = \rho \frac{L}{A}$$

**R** = resistance in ohm per phase

$\rho$  = specific resistance,  $\Omega \cdot \text{mm}^2/\text{m}$

**A** = Conductor area,  $\text{mm}^2$

Resistance as a function of temperature

$$R_{20} = R_t \times k_t \times \frac{1000}{L}$$

**$k_t$**  = is the temperature correction factor from below table or from below formula

**$k_{20}$**  = is the conductor resistance at 20 °C, in  $\Omega/\text{km}$ ;

**$R_t$**  = is the measured conductor resistance, in  $\Omega$ ;

**L** = is the length of cable, in m.

**Correction factors are applied as bellow:**

Temperature [ °C ]	5	10	15	20	25	30	35	40	45	50
Kt	1.064	1.042	1.020	1.000	0.980	0.962	0.943	0.926	0.909	0.893
Temperature [ °C ]	55	60	65	70	75	80	85	90	95	
Kt	0.877	0.862	0.847	0.833	0.820	0.806	0.794	0.781	0.769	

**Formula for Temperature Correction factor of copper conductors.**

$$k_{t,Cu} = \frac{254,5}{254,5 + t} = \frac{1}{1 + 0,00393(t-20)}$$

## Electrial Paramenters for Instrumentation Cables

Nominal cross section	$\text{mm}^2$	0,5	0,75	1	1,5	2,5
Conductor resistance at 20 °C, max	$\Omega/\text{km}$	40,4	26,0	19,2	12,8	7,86
Loop resistance of pair at 20 °C, max	$\Omega/\text{km}$	80,8	52	38,4	25,6	15,72
Mutual Capacitance at 1 kHz, max	$\text{nF}/\text{km}$	150	150	150	150	150
Loop inductance at 1 kHz, max	$\text{mH}/\text{km}$	1,0	1,0	1,0	1,0	1,0
Inductance to resistance ratio (L/R)	$\mu\text{H}/\Omega$	25	25	25	40	60

# TECHNICAL DATA

## CONDUCTOR RESISTANCE

### Power Cables

Nominal Cross-section of conductor	Class 2				Class 5			
	Bare copper		Tinned copper		Bare copper		Tinned copper	
	Maximum resistance at 20 °	Maximum resistance at 90 °	Maximum resistance at 20 °	Maximum resistance at 90 °	Maximum resistance at 20 °	Maximum resistance at 90 °	Maximum resistance at 20 °	Maximum resistance at 90 °
mm <sup>2</sup>	Ω/km							
1	18,1	23,1	18,2	23,2	19,5	24,9	20,0	25,5
1,5	12,1	15,4	12,2	15,6	13,3	17,0	13,7	17,5
2,5	7,41	9,45	7,6	9,64	7,98	10,2	8,21	10,47
4	4,61	5,88	4,70	5,99	4,95	6,3	5,09	6,49
6	3,08	3,93	3,11	3,97	3,30	4,2	3,39	4,32
10	1,83	2,33	1,84	2,35	1,91	2,4	1,95	2,49
16	1,15	1,47	1,16	1,48	1,21	1,5	1,24	1,58
25	0,727	0,927	0,734	0,936	0,78	0,995	0,795	1,014
35	0,524	0,668	0,529	0,675	0,554	0,706	0,565	0,720
50	0,387	0,493	0,391	0,499	0,386	0,492	0,393	0,501
70	0,368	0,342	0,270	0,344	0,272	0,347	0,277	0,353
95	0,193	0,249	0,195	0,249	0,206	0,263	0,210	0,268
120	0,153	0,195	0,154	0,196	0,161	0,205	0,164	0,209
150	0,124	0,158	0,126	0,161	0,129	0,164	0,132	0,168
185	0,0991	0,1264	0,100	0,128	0,106	0,135	0,108	0,138
240	0,0754	0,0961	0,0762	0,0972	0,0801	0,1021	0,0817	0,1042
300	0,0601	0,0766	0,0607	0,0774	0,0641	0,0817	0,0654	0,0834

### Instrumentation, control and communications cables

Nominal cross-sectional of conductor	Class 2		Class 5	
	Resistance of plain copper conductors at 20 ° C	DC resistance of tinned copper conductors at 20 ° C	DC resistance of plain copper conductors at 20 ° C	DC resistance of tinned copper conductors at 20 ° C
mm <sup>2</sup>	Ω/km			
0,5	40,4	41,6	41,4	42,5
0,75	26,0	26,3	27,6	28,3
1	19,2	19,3	20,7	21,2
1,5	12,8	12,9	14,1	14,5
2,5	7,86	8,02	8,47	8,71

# TECHNICAL DATA

## VOLTAGE DROP

In the absence of specific design limits set by a regulatory body, the cross-sectional areas of conductors shall be so determined that when the conductors are carrying the maximum current under normal conditions of service, the drop in voltage from the main or emergency switchboard bus-bars to any and every point on the installation does not exceed the limitation given in Clause 36 of IEC 60092-201

Current carrying in cable core(s) induce(s) a voltage drop and value of this voltage drop is the difference between the measured voltages at both ends of the cable

Generally accepted values are 3% for lighting and 5% for motors and other applications.

Voltage drop depends on:

- Type of current (DC) or (AC)
- Single or tri-phased systems.
- Length of the cable
- Carrying current capacity and power factor.
- Electrical resistance and inductance.

### In DC system

$$V_d = 2 \times I \times L \times R$$

### In AC Single Phase System

$$V_d = 2 \times I \times L (R \cdot \cos \phi + X \cdot \sin \phi) \quad I = \text{Conductor length (m)}$$

### In AC Three Phase System

$$V_d = \sqrt{3} \times I \times L \times (R \cdot \cos \phi + X \cdot \sin \phi)$$

Where

V <sub>drop</sub>	Voltage drop (V)
R	D. C. conductor resistance at max rated conductor temperature ( $\Omega$ /km)
L	Cable length (km)
I	Current rating value (A)
Cos $\phi$	Power factor if no details, power factor is Cos $\phi$ = 0.8 and Sin $\phi$ = 0.6.
X	Reactance ( $\Omega$ / km)

# TECHNICAL DATA

## VOLTAGE DROP

### For Class 5 Conductors

Cross Section mm <sup>2</sup>	Conductor Resistance			App. Voltage Drop at 90 °C		
	Resistance at +20 °C ohm/km	Resistance at +45 °C ohm/km	Resistance at +90 °C ohm/km	DC mV/Am	Single Phase mV/Am (*)	Three Phase mV/Am (*)
1,5	13,3	14,607	16,959	33,92	27,13	23,50
2,5	7,98	8,765	10,176	20,35	16,28	14,10
4	4,95	5,437	6,312	12,62	10,10	8,75
6	3,3	3,625	4,208	8,42	6,73	5,83
10	1,91	2,098	2,436	4,87	3,90	3,38
16	1,21	1,329	1,543	3,09	2,47	2,14
25	0,78	0,857	0,995	1,99	1,59	1,38
35	0,554	0,609	0,707	1,41	1,13	0,98
50	0,386	0,424	0,493	0,986	0,789	0,683
70	0,272	0,299	0,347	0,694	0,555	0,481
95	0,206	0,227	0,263	0,526	0,421	0,364
120	0,161	0,177	0,206	0,412	0,330	0,285
150	0,129	0,142	0,165	0,330	0,264	0,229
185	0,106	0,117	0,136	0,272	0,218	0,188
240	0,0801	0,088	0,103	0,206	0,165	0,143

(\*) : At Cos  $\phi$  = 0,8 and at 50 Hz

### For Class 2 Conductors

Cross Section mm <sup>2</sup>	Conductor Resistance			App. Voltage Drop at 90 °C		
	Resistance at +20 °C ohm/km	Resistance at +45 °C ohm/km	Resistance at +90 °C ohm/km	DC mV/Am	Single Phase mV/Am (*)	Three Phase mV/Am (*)
1,5	12,1	13,289	15,429	30,86	24,69	21,38
2,5	7,41	8,139	9,449	18,90	15,12	13,09
4	4,61	5,063	5,879	11,76	9,41	8,15
6	3,08	3,383	3,928	7,86	6,28	5,44
10	1,83	2,010	2,334	4,67	3,73	3,23
16	1,15	1,263	1,467	2,93	2,35	2,03
25	0,727	0,799	0,927	1,85	1,48	1,28
35	0,524	0,576	0,669	1,34	1,07	0,93
50	0,387	0,426	0,494	0,988	0,79	0,685
70	0,268	0,295	0,342	0,684	0,55	0,474
95	0,193	0,212	0,247	0,494	0,40	0,342
120	0,153	0,169	0,196	0,392	0,31	0,272
150	0,124	0,137	0,159	0,318	0,25	0,220
185	0,0991	0,109	0,127	0,254	0,20	0,176
240	0,0754	0,083	0,097	0,194	0,16	0,134

(\*) : At Cos  $\phi$  = 0,8 and at 50 Hz

# TECHNICAL DATA

## TESTS ON ELECTRIC CABLES UNDER FIRE CONDITIONS

**IEC 60332/3** Fire test on bunched and vertical laid cables.  
Test chamber

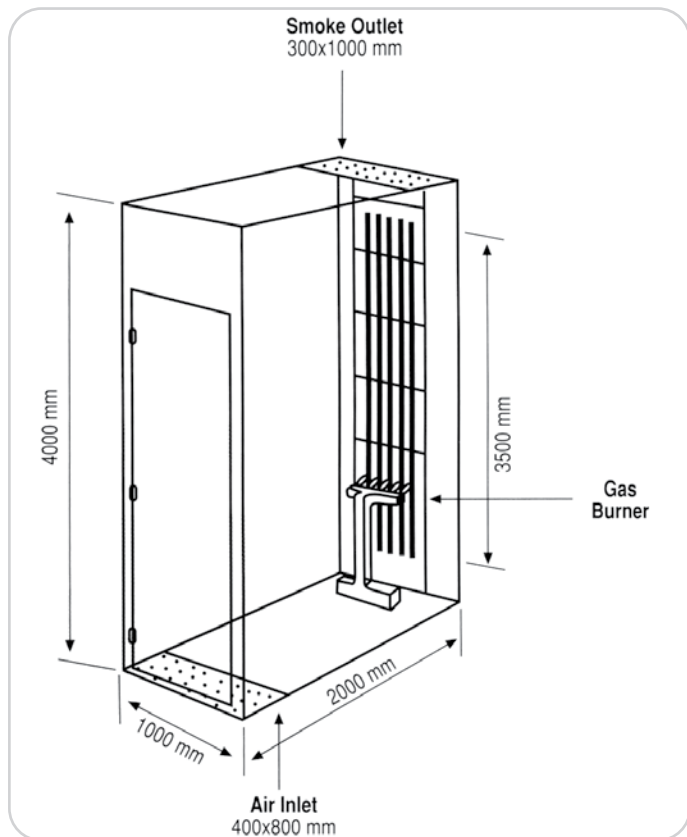

### Flame application time

Required volume of combustible material  
per 1 m of cable bunch (lt) : V

IEC 60332/3 CATEGORY	V	MINIMUM BURNING TIME
A	7lt.	40 minutes
B	3.5lt.	40 minutes
C	1.5lt	20 minutes

### Test Conditions of IEC 60332/3

This test is to determine the fire propagation characteristics of a bunch of cables. The test should be carried out if the external wind speed measured by an anemometer fitted on the top of the test rig is not greater than 5 m/s and the temperature of the walls of the test chamber is in between 5 °C and 40 °C. The temperature inside of the chamber should be 23±5 °C before the test

## IEC 60331 - 21 Fire Test for circuit integrity

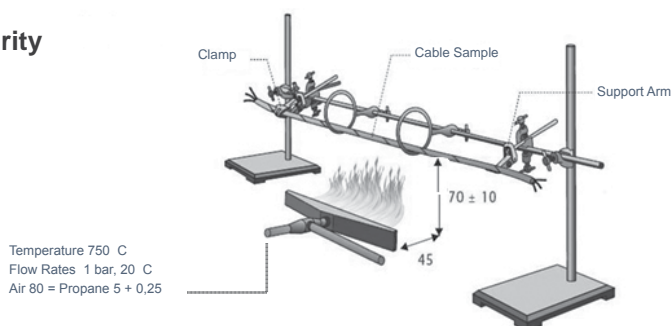

**IEC 60332/1** Fire test on a vertical laid single cable. Test chamber

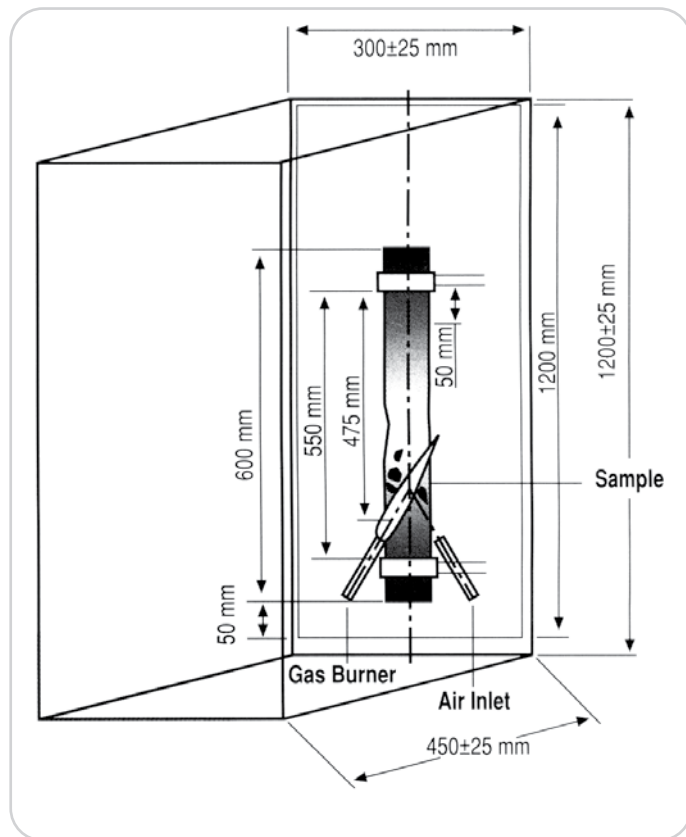

### Flame application time

Weight of test piece (kg) : m  
Flame application time (s) = 60+m/25



# TECHNICAL DATA

## Cables and Drums User Guide Drums Handling

### 1.1. Position of Drums

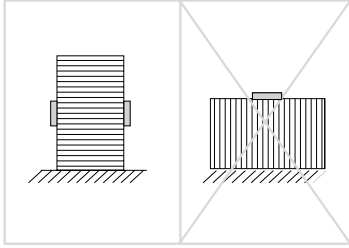

### 1.2. Loading

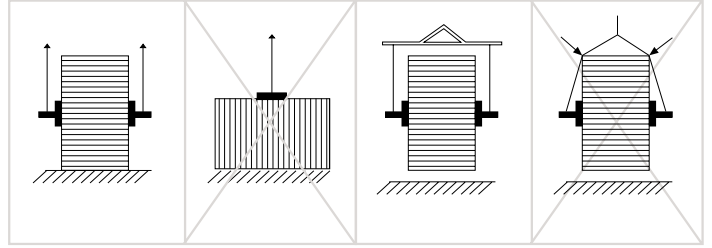

### 1.3. Unloading

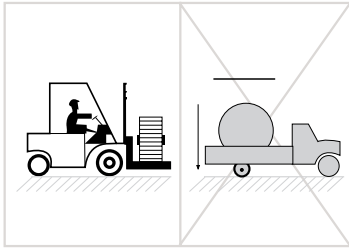

### 1.4. Handling by forklift

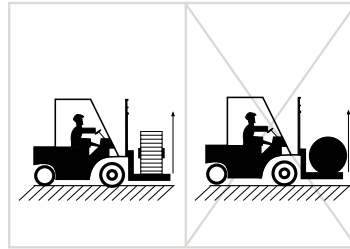

### 1.5. Rolling

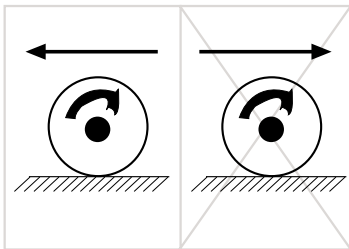

### 1.6. Paying-off the Cable

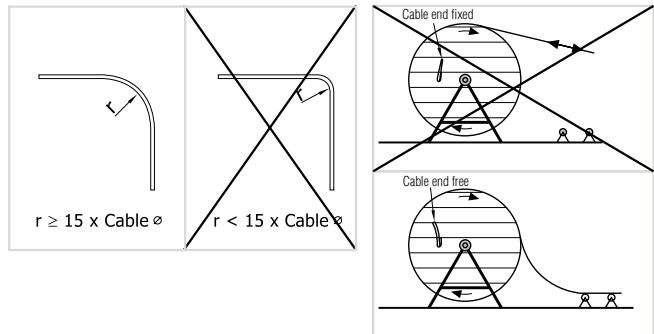

## Transport Requirements

### 2.1. Position of the Drums

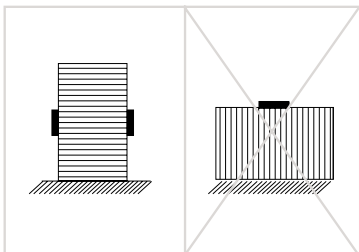

### 2.2. Fastening Drums

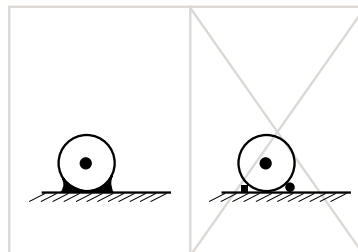

## Cables and Drums User Guide

### 2.3. Use of nails

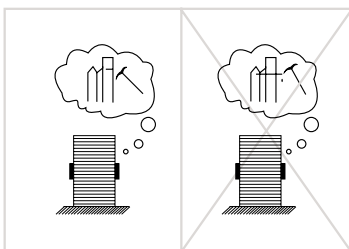

### 2.4. Bigger Drums

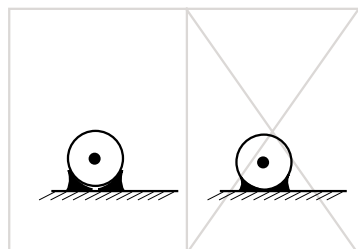

# TECHNICAL DATA

## 2.5. Binding of the Drums

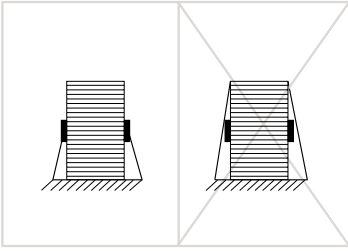

## 2.6. Multiple Drum Storage

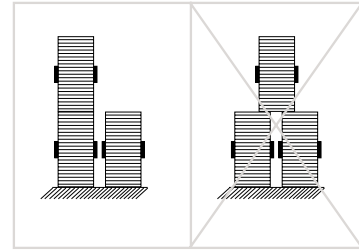

## Storage Requirements

### 3.1. Do not store near heat sources

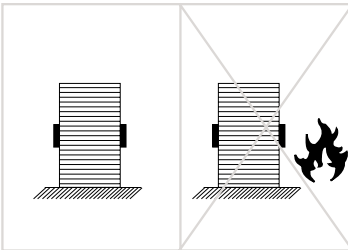

### 3.2. Do not store on vibrating surfaces. (Ship engine room etc.)

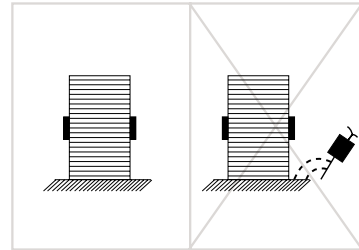

### 3.3. Do not store on irregular surfaces.

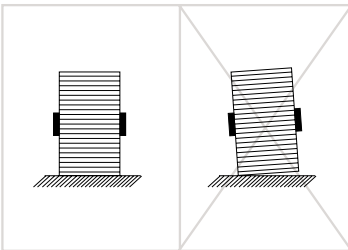

### 3.4. Do not store on soft surfaces

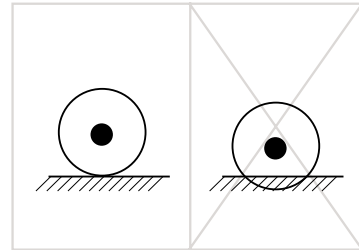

## Cables and Drums User Guide

3.5. Do not store on areas liable of flooding. All cable ends must be fully sealed at all times to prevent the ingress of water. It is preferable to store reels off the ground on timbers or other supports. In damp locations, it is advisable to allow at least 3 inches between reels to permit circulation of air.

3.6. If storage is likely to last more than 6 months, drums should be stored in order to be protected from effects like rain, sunlight etc.

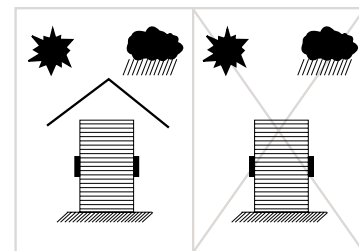
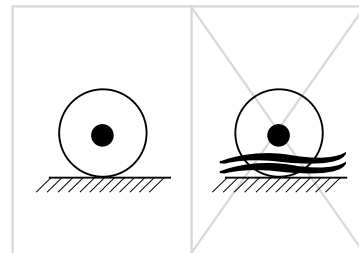













**OFFSHORE  
CABLES**



**AIRPORT  
CABLES**



**CRANE  
CABLES**



**MINING  
CABLES**



**DEFENSE  
INDUSTRY  
CABLES**



**MARINE  
CABLES**

**RAILWAY  
CABLES**

**INDUSTRIAL  
CABLES**

**TUNNELLING  
CABLES**

**INSTRUMENTATION  
CABLES**

**Üntel Kabloları San. ve Tic. A.Ş.**

Makine O.S.B. 6. Cadde No:4/41455 Dilovası, Kocaeli - TÜRKİYE

Tel: +90 262 722 93 30 Fax: +90 262 722 94 43

info@untel.com.tr | www.untel.com.tr