



Quality Through Experience

INDUSTRIAL CABLES



Copyright © Notice and Disclaimer:

All data in this catalogue are only informative. ÜNTEL KABLOLARI SAN. TIC. AS. reserve the right to modify the data at any time shown in this catalogue without notice. No part of this catalogue may be reproduced, distributed, or transmitted in any form or by any means, including photocopying, recording, or other electronic or mechanical methods, without the prior written permission of the Üntel Kablo. The names, trademarks and designs of our products are all protected by law. It does not constitute a warrantee of any kind, expressed or implied, of our products or their suitability for any particular use. There is no responsibility of the manufacturer for damages to persons and property in case of improper use, operation and installation of cables in this catalogue or/and neglecting the recommendations, standards and norms written in this catalogue.

Industrial Cables



Quality Through Experience

HALF A CENTURY OF EXPERIENCE

HALF A CENTURY OF EXPERIENCE

Exporting Over 80 Countries on 6 Continents

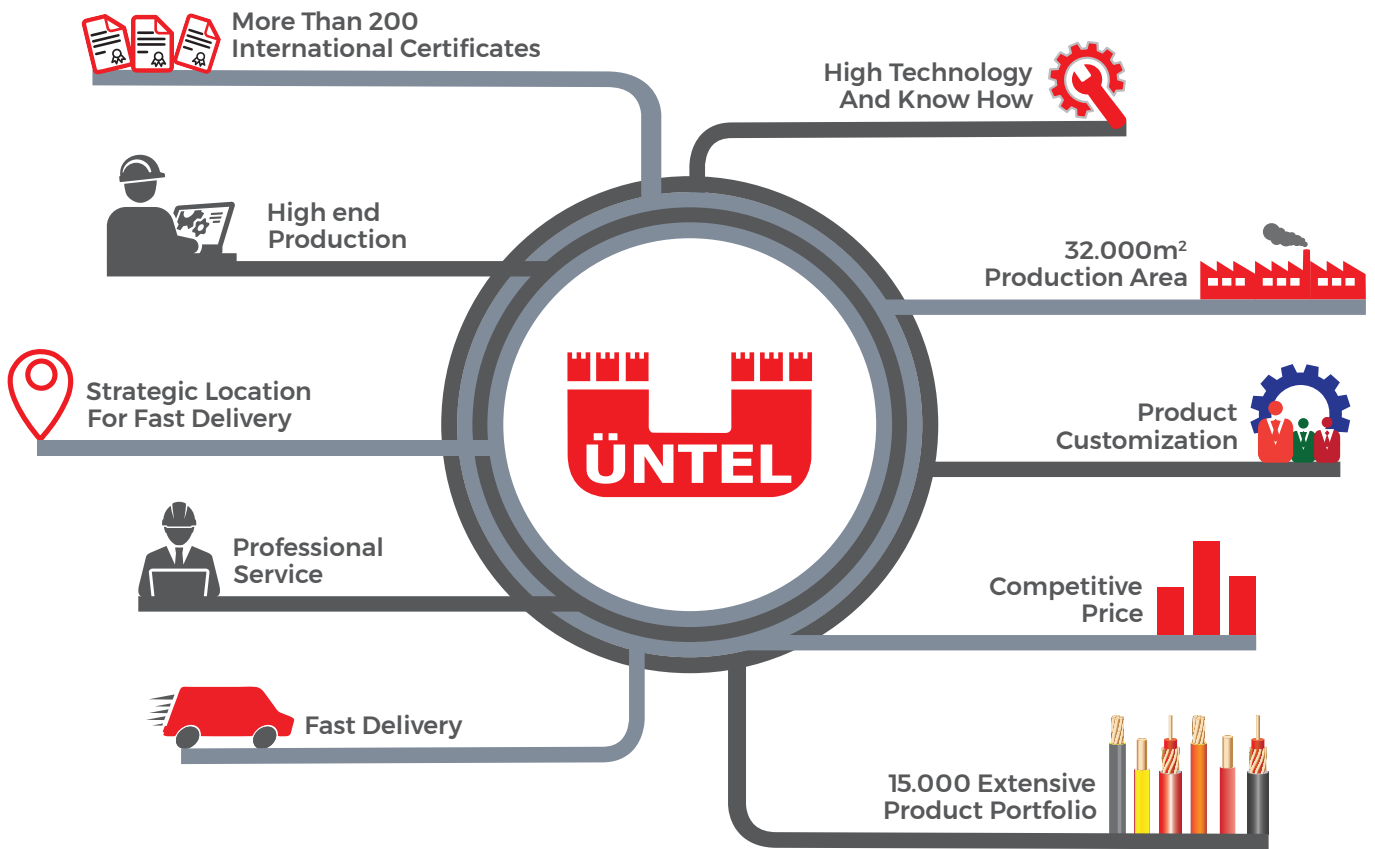

INDUSTRIAL CABLES

MARINE CABLES

OFFSHORE CABLES

MINING & TUNNELING CABLES

AIRPORT CABLES

RAILWAY CABLES

CRANE CABLES

DEFENSE INDUSTRY CABLES

INSTRUMENTATION CABLES



ABOUT US

ÜNTEL KABLO, one of leading cable manufacturers in the world was established in 1972, Turkey. With almost 50 years of experience, continuously develops and optimize her product range with the help of advanced technology and well trained staff.

Product range consists over 15.000 different types of cables, covers both rubber and thermoplastic cables up to Medium Voltage (MV) range. ÜNTEL's power and instrumentation cables supplies energy for industries which requires experience like marine, offshore, mines and tunnels, airports, railways and have been used in industrial ways such as heavy-duty rubber drum reeling cables, welding cables, control cables and fire resistant cables. ÜNTEL is also able to produce tailor made products for special purposes. Today these products are exported over 70 countries on six continents.

By the end of 2009, ÜNTEL finalized the investment of a new high-tech plant near Istanbul. Now continues her operations on 43.000 m2 land space with 32.000 m2 closed area. By having 3.000 tons copper drawing and 4.000 tons different type of

compound processing capacity, ÜNTEL produces 30.000 tones of cable per year. By means of new factory building, state of the art machines and unique ERP system investments ÜNTEL aimed absolute customer satisfaction.

Üntel's laboratories which are approved by organisations that specify the standars are equipped with advanced technology test and measurement devices. Within the scope of Quality System Certificates there is a quality management system presents in Üntel according to ISO, IQnet and TSE quality standards.. Around 200 different types of cables are certified by global organisations like VDE, KEMA, ABS, UL, BV, DNV-GL, RINA and TSE.

Üntel Kablo evaluate customer needs and expectations in a sectoral wiew and provide effective solutions with hundred percent customer satisfaction and qualified production philisopy. Üntel's biggest value is well trained and experienced staff and believe that exceptional quality comes through this experience.

Üntel Kablo offers 15.000 different types of Rubber, PVC, PE, LSZH and Polyurethane cables complying with global standards.



Solution partner of your projects..



INDUSTRIAL CABLES

Quality Through Experience

Üntel Kablo as one of the leading cable manufacturer of the world offers a wide range of cables for nearly all industrial application fields.

In this catalogue Üntel Kablo presents its series of industrial cables which are used in, but not limited with, power plants, factories, construction sites, machine and equipment manufacturers, GSM infrastructures and EPC companies for power, control and signal transmission.

Industrial cables are specially designed and built for demanding applications to show high performance for a longer working life time. According to their structure these cables withstand against chemicals and oils, high temperatures, weather and environmental conditions, tensile and torsional stress' and other alternating conditions. Üntel provides cables from 300V to 35KV in a variety of jacketing materials suited for specific applications.

Our cables are produced with best quality compounds together with our decades of production experience to create solutions and adds value for industries. By means of the ability of processing many types of compounds Üntel Kablo offers Rubber, PVC, PE, LSZH and Polyurethane cables complying with HAR, VDE and Italian standards.

With the philosophy of being a solution partner for our customers; Üntel provides tailor-made cable solutions according to specific requirements. By evaluating the needs, expectations and highest level of requirements of our customers we can supply specific cable features and unique solutions that developed throughout years of experience.

Since the compliance to standards, quality, safety, availability and reliability are vital and very important in plant engineering and heavy industries, all of the cables that leaving Üntel factory produced and tested according to related cable standards, Project specifications and requirements that ensures the continuity of the industry without unexpected breakdowns.

Continuously investing on Research & Development, being in the market with almost 50 years of experience, producing wide variety of cables with high tech equipment and having well trained staff enables Üntel to support its customer's requirements and needs by supplying the best quality products.



INDEX

	<u>PAGE</u>		<u>PAGE</u>
• H01N2-D	10	• H05VV-F	110
• H05RR-F	14	• H05VV5-F (NYSLYÖ-JZ)	114
• H05RN-F	16	• H05VVC4V5-K (NYSLYCYÖ-JZ)	118
• H07RN-F	18	• YSLY	122
• H07RN8-F	24	• YSLCY	128
• OZÜNFLEX®	30	• YSLCY	134
• H07BN4-F	32	• LIYY	138
• 07RC4N-F	38	• LIYCY	142
• 07RNH6-F	42	• LIHH	146
• H07ZZ-F	46	• LIHCH	150
• H07Z-K	50	• HSLH	154
• H07BQ-F	52	• HSLCH	158
• H03RT-H	54	• H07VVH6-F (UNFLAT)	162
• EPR/CSP	56	• PENDANT	166
• NSGAFÖU	58	• PVC/PUR	168
• NGFLGÖU	62	• PVC/PUR-C	170
• NGFLCGÖU	66	• UNFLEX PUR	172
• NSHTÖU	70	• UNFLEX PUR-C	176
• (N)SHTÖU-POLIP	74	• 2YSLCY-J	180
• NSSHÖU	76	• 2XSLCH-J	182
• (N)SSHCÖU	80	• H05V-K/H07V-K	184
• Supreme (N)TSCGEWÖU	82	• H05Z1-K/H07Z1-K	186
• FROR	86	• 052XZ1-F	188
• FROH2R	88	• YVV (NYY) FLEX	190
• FG7R/FG7OR	92	• (N)HXH FE180 PH120 / E90	194
• FG7OH2R	96	• SYMBOLS/ICONS	199
• FG7OHH2R	100	• TECHNICAL DATA	203
• FG7M1/FG7OM1	102		
• RG7H1R/RG7H1OR	106		

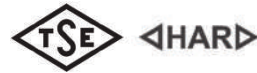

CABLE STRUCTURE

Conductor	Electrolytic annealed, class 6 stranded plain copper wires <i>Class 5 copper wires for 120 mm² and above</i> (tinned conductor on request)
Seperator	A suitable tape may be applied over the conductor
Insulation	EM5 type cross-linked elastomeric compound (EN 50363-2-2)
Color	Black (Red or Orange on request)

MAIN CHARACTERISTICS

Construction	EN 50525-2-81, VDE 0285-525-2-81, IEC 60245-6
General Requirements	EN 50525-1, VDE 0285-525-1, IEC 60245-1
Guide to Use	EN 50565-1/2, VDE 0298-565-1
Electrical Tests	EN 50395, IEC 60245-2
Non-electrical Tests	EN 50396, IEC 60245-2
Conductor Resistance	IEC 60228, VDE 0295
Flame Retardant	IEC 60332-1-2, VDE 0482-332-1-2
Oil Resistant	EN 60811-404, VDE 0473-811-404

OPERATING CHARACTERISTICS

Rated Voltage	100 V / 100 V (U ₀ /U)
Max. Operating Voltage AC	110 V / 110 V
Max. Operating Voltage DC	150 V
AC Test Voltage	1 kV
Operating Tempetature	
<i>In Flexing Use</i>	-20°C to +85°C
<i>In Fixed Use</i>	-40°C to +85°C
Conductor Short-Circuit Temp.	250°C (Max. 5 sec)
Min. Installation Temp.	-20°C
Min. Bending Radius	EN 50565-1 Tab. 3
Current Carrying Capacities	VDE 0298-4, Tab. 16

APPLICATIONS

These flexible cables are used in several industries as hand-plier connections for 100 V welding machines. Their structure makes them available to use in open spaces, wet and oily environments. They are resistant to cold, UV, ozone, moisture, heat and hot particles.



H01N2-D

Cross Section (mm ²)	Nominal Overall Diameter (mm)	Approximate Weight (kg/km)	Min.Bending Radius (free movement) (mm)	Max. Resistance of Conductors at 20°C (ohm / km)
1x10	8,30	137	33	1,91
1x16	9,40	197	38	1,21
1x25	10,90	279	44	0,780
1x35	12,10	369	61	0,554
1x50	14,20	515	71	0,386
1x70	16,30	712	82	0,272
1x95	18,40	916	92	0,206
1x120	20,40	1169	122	0,161
1x150	22,20	1453	133	0,129
1x185	24,90	1802	149	0,106
1x240	27,80	2327	167	0,0801



Rated current values are recommended according to VDE 0298-4 table 16. at ambient temperature of 30 °C

Current rating for repeat cycle operation based on 5 min repeat period

Nominal cross section area (mm ²)	Current rating (A)						
	100% duty cycle	85% duty cycle	80% duty cycle	60% duty cycle	35% duty cycle	20% duty cycle	8% duty cycle
10	96	97	98	102	114	137	198
16	130	132	134	142	166	204	301
25	173	179	181	196	234	293	442
35	216	226	229	250	304	384	584
50	274	287	293	323	398	508	779
70	341	360	368	409	510	655	1011
95	413	438	448	502	632	816	1266
120	480	511	523	588	745	966	1502
150	557	594	609	687	875	1137	1771
185	638	683	700	793	1012	1319	2059

Current rating for repeat cycle operation based on a 10 min repeat period

Nominal cross section area (mm ²)	Current rating (A)						
	100% duty cycle	85% duty cycle	80% duty cycle	60% duty cycle	35% duty cycle	20% duty cycle	8% duty cycle
10	96	96	96	97	102	113	152
16	130	131	131	133	144	167	233
25	173	175	176	182	204	244	351
35	216	220	222	233	268	324	477
50	274	281	284	303	356	439	654
70	341	352	358	387	463	578	872
95	413	430	438	478	582	734	1117
120	480	503	513	564	692	880	1348
150	557	586	597	641	819	1046	1609
185	638	674	688	765	955	1226	1892

Correction factors acc. to the different ambient temperature use table 17 given in technical data section.





◀HARD▶



CABLE STRUCTURE

Conductor	Electrolytic annealed, class 5 stranded plain copper wires (tinned conductor on request)
Separator	A suitable tape may be applied over the conductor
Insulation	EI4 type cross-linked elastomeric compound, EPR (EN 50363-1)
Sheath	EM3 type cross-linked elastomeric compound (EN 50363-2-1)
Color	Black



MAIN CHARACTERISTICS

Construction	EN 50525-2-21, VDE 0285-2-21, IEC 60245-4
General Requirements	EN 50525-1, VDE 0285-525-1, IEC 60245-1
Guide to Use	EN 50565-1/2, VDE 0298-565-1
Electrical Tests	EN 50395, IEC 60245-2
Non-electrical Tests	EN 50396, IEC 60245-2
Conductor Resistance	IEC 60228, VDE 0295
Flame Retardant	IEC 60332-1-2, VDE 0482-332-1-2
Oil Resistant	EN 60811-404, VDE 0473-811-404

OPERATING CHARACTERISTICS

Rated Voltage	300/500 V (U ₀ /U)
AC Test Voltage	2 kV
Operating Temperature (In flexing use)	-25°C to +60°C (Without mechanical shocks)
Conductor Short-Circuit Temp.	200°C. (Max. 5 sec)
Min. Installation Temp.	-25°C
Min. Bending Radius	EN 50565-1 Tab. 3
Current Carrying Capacities	VDE 0298-4 Tab. 11

APPLICATIONS

These cables are available to use in both low and medium stressed subjects; as connection of fixed and mobile equipment connections such as household and office equipments. They can be used indoor, temporary outdoor, damp places, dry and wet environments. It's not suitable for permanent outdoor use.



Cross Section (mm ²)	Nominal Overall Diameter (mm)	Approximate Weight (kg / km)	Min.Bending Radius (free movement) (mm)	Max. Resistance of Conductors at 20°C (ohm / km)
2x0,75	6,20	53	25	26,00
2x1	6,80	66	27	19,50
2x1,5	8,20	97	33	13,30
2x2,5	9,40	133	38	7,98
2x4	11,00	190	44	4,95
3x0,75	6,80	67	27	26,00
3x1	7,20	79	29	19,50
3x1,5	8,70	115	35	13,30
3x2,5	10,00	164	40	7,98
3x4	11,70	234	47	4,95
3x6	13,20	314	66	3,30
4x0,75	7,40	80	30	26,00
4x1	7,85	94	31	19,50
4x1,5	9,70	145	39	13,30
4x2,5	11,05	203	44	7,98
4x4	13,10	299	66	4,95
4x6	14,62	398	73	3,30
5x0,75	8,30	98	33	26,00
5x1	8,80	115	35	19,50
5x1,5	10,60	172	42	13,30
5x2,5	12,40	249	62	7,98
5x4	14,50	361	73	4,95



CABLE STRUCTURE

Conductor	Electrolytic annealed, class 5 stranded plain copper wires (tinned conductor on request)
Separator	A suitable tape may be applied over the conductor
Insulation	EI4 type cross-linked elastomeric compound, EPR (EN 50363-1)
Sheath	EM2 type cross-linked elastomeric compound (EN 50363-2-1)
Color	Black

MAIN CHARACTERISTICS

Construction	EN 50525-2-21, VDE 0285-2-21, IEC 60245-4
General Requirements	EN 50525-1, VDE 0285-525-1, IEC 60245-1
Guide to Use	EN 50565-1/2, VDE 0298-565-1
Electrical Tests	EN 50395, IEC 60245-2
Non-electrical Tests	EN 50396, IEC 60245-2
Conductor Resistance	IEC 60228, VDE 0295
Flame Retardant	IEC 60332-1-2, VDE 0482-332-1-2
Oil Resistant	EN 60811-404, VDE 0473-811-404

OPERATING CHARACTERISTICS

Rated Voltage	300/500 V (U ₀ /U)
AC Test Voltage	2 kV
Operating Temperature	
<i>In Flexing Use</i>	-25°C to +60°C
<i>In Fixed Use</i>	-40°C to +90°C
Conductor Short-Circuit Temp.	200°C (Max. 5 sec)
Min. Installation Temp.	-25°C
Min. Bending Radius	EN 50565-1 Tab. 3
Current Carrying Capacities	VDE 0298-4 Tab. 11

APPLICATIONS

These cables are available to use in both low and medium stressed subjects; as connection of fixed and mobile equipment connections such as household and office equipments. They can be used indoor, outdoor, damp places, oily, dry and wet environments.



FLAME RETARDANT



OIL RESISTANT



UV RESISTANT



WEATHER RESISTANT

Cross Section (mm²)	Nominal Overall Diameter (mm)	Approximate Weight (kg / km)	Min.Bending Radius mm (free movement)	Max. Resistance of Conductors at 20°C (ohm / km)
2x0,75	6,20	53	25	26,00
2x1	6,80	66	27	19,50
3x0,75	6,80	67	27	26,00
3x1	7,20	79	29	19,50
4x0,75	7,40	80	30	26,00
4x1	7,85	94	31	19,50



◀HARD▶



CABLE STRUCTURE

Conductor	Electrolytic annealed, class 5 stranded plain copper wires (tinned conductor on request)
Seperator	A suitable tape may be applied over the conductor
Insulation	EI4 type cross-linked elastomeric compound, EPR (EN 50363-1)
Inner Sheath	EM2 or EM3 type cross-linked elastomeric compound (EN 50363-2-1) <i>If outer sheath thickness is greater than 2,4 mm</i>
Outer Sheath	EM2 type cross-linked elastomeric compound (EN 50363-2-1)
Color	Black (other colors available on request)

MAIN CHARACTERISTICS

Construction	EN 50525-2-21, VDE 0285-2-21, IEC 60245-4
General Requirements	EN 50525-1, VDE 0285-525-1, IEC 60245-1
Guide to Use	EN 50565-1/2, VDE 0298-565-1
Electrical Tests	EN 50395, IEC 60245-2
Non-electrical Tests	EN 50396, IEC 60245-2
Conductor Resistance	EN 60228, VDE 0295
Flame Retardant	IEC 60332-1-2, VDE 0482-332-1-2
Oil Resistant	EN 60811-404, VDE 0473-811-404

OPERATING CHARACTERISTICS

Rated Voltage	450/750 V (U ₀ /U)
AC Test Voltage	2,5 kV
Operating Temperature	
<i>In Flexing Use</i>	-25°C to +60°C
<i>In Fixed Use</i>	-40°C to +90°C
Conductor Short-Circuit Temp.	200°C (Max. 5 sec)
Min. Installation Temp.	-25°C
Min. Bending Radius	EN 50565-1 Tab. 3
Current Carrying Capacities	VDE 0298-4 Tab.13, IEC 60364-5-52 Tab. B.5212 & Tab. C.521

*It's allowed up to 1.000 V AC or DC using for fixed and protected installations.

APPLICATIONS

These rubber sheathed flexible cables are used as power and control cables in open-built plants, industry works, electrical tools and mobile equipments under heavy conditions and medium mechanical stress. Due to it's construction it can be used indoor, outdoor, wet, oily, damp places and explosion hazard areas. Üntel Kablo certifies the usage of this cable permanently submerged in water up to 10 bar (100 mts) and IPX8 tested by TUV



FLAME RETARDANT



OIL RESISTANT



UV RESISTANT



WEATHER RESISTANT



WATER RESISTANT



SUBMERSION 100 MT (ADB)

Cross Section (mm ²)	Nominal Overall Diameter (mm)	Approximate Weight (kg / km)	Min.Bending Radius (free movement) (mm)	Max. Resistance of Conductors at 20°C (ohm / km)
1x1,5	6,00	50	24	13,30
1x2,5	6,40	63	26	7,98
1x4	7,30	85	29	4,95
1x6	8,10	111	32	3,30
1x10	10,20	179	41	1,91
1x16	11,00	238	44	1,21
1x25	13,80	365	69	0,78
1x35	15,30	475	77	0,554
1x50	17,80	657	89	0,386
1x70	19,40	864	97	0,272
1x95	22,10	1118	133	0,206
1x120	24,40	1404	146	0,161
1x150	27,40	1698	83	0,129
1x185	29,70	2100	178	0,106
1x240	32,60	2396	196	0,0801
1x300	35,60	3256	214	0,0641
1x400	40,90	4377	245	0,0486
1x500	45,60	5632	274	0,0384
1x630	49,30	6975	296	0,0287
2x1	8,40	94	34	19,50
2x1,5	9,30	117	37	13,30
2x2,5	10,60	160	42	7,98
2x4	12,20	221	61	4,95
2x6	13,60	288	68	3,30
2x10	19,20	555	96	1,91
2x16	21,00	717	126	1,21
2x25	26,70	1124	160	0,78
2x35	29,40	1421	176	0,554
2x50	34,40	1968	206	0,386
2x70	38,30	2564	230	0,272
2x95	43,70	3330	262	0,206
3x1	9,10	114	36	19,50

Cross Section (mm ²)	Nominal Overall Diameter (mm)	Approximate Weight (kg / km)	Min.Bending Radius (free movement) (mm)	Max. Resistance of Conductors at 20°C (ohm / km)
3x1,5	9,90	140	40	13,30
3x2,5	11,40	196	46	7,98
3x4	13,10	273	66	4,95
3x6	14,60	358	73	3,30
3x10	20,60	682	124	1,91
3x16	22,50	892	135	1,21
3x25	28,60	1390	172	0,78
3x35	31,70	1789	190	0,554
3x50	37,00	2474	222	0,386
3x70	40,90	3231	245	0,272
3x95	46,90	4220	281	0,206
3x120	51,60	5248	310	0,161
3x150	56,20	6319	337	0,129
3x185	62,30	7806	374	0,106
3x240	69,50	9963	417	0,0801
3x300	76,70	11894	460	0,0641
3x2,5+1,5	12,30	229	62	7,98
3x4+2,5	14,00	316	70	4,95
3x6+4	15,80	425	79	3,30
3x10+6	22,40	810	134	1,91
3x16+10	24,60	1070	148	1,21
3x25+16	31,40	1687	188	0,78
3x35+16	34,60	2114	208	0,554
3x50+25	40,60	2945	244	0,386
3x70+35	44,50	3820	267	0,272
3x95+50	51,00	5008	306	0,206
3x120+70	56,00	6267	336	0,161
3x150+70	60,90	7432	365	0,129
3x185+95	68,40	9296	410	0,106
3x240+120	76,50	11881	459	0,0801
3x300+150	84,40	14580	506	0,0641
4x1	10,10	143	40	19,50

Cross Section (mm ²)	Nominal Overall Diameter (mm)	Approximate Weight (kg / km)	Min.Bending Radius (free movement) (mm)	Max. Resistance of Conductors at 20°C (ohm / km)
4x1,5	11,00	175	44	13,30
4x2,5	12,60	244	63	7,98
4x4	14,50	342	73	4,95
4x6	16,30	456	82	3,30
4x10	22,60	845	136	1,91
4x16	24,70	1114	148	1,21
4x25	31,80	1760	191	0,78
4x35	35,20	2265	211	0,554
4x50	41,10	3136	247	0,386
4x70	45,00	4098	270	0,272
4x95	52,00	5393	312	0,206
4x120	56,80	6657	341	0,161
4x150	62,20	8067	373	0,129
4x185	69,70	10030	418	0,106
4x240	77,60	12786	466	0,0801
4x300	85,80	15799	515	0,0641
5x1	11,10	170	44	19,50
5x1,5	12,10	208	61	13,30
5x2,5	13,80	290	69	7,98
5x4	16,10	415	81	4,95
5x6	18,10	554	91	3,30
5x10	24,90	1033	149	1,91
5x16	27,40	1377	164	1,21
5x25	35,40	2183	212	0,78
5x35	38,90	2788	233	0,554
5x50	45,80	3902	275	0,386
5x70	50,20	5113	301	0,272
5x95	57,80	6693	347	0,206
6x1,5	14,40	289	72	13,30
6x2,5	16,20	1123	81	7,98
6x4	18,70	551	94	4,95
7x1,5	15,40	337	77	13,30

Cross Section (mm ²)	Nominal Overall Diameter (mm)	Approximate Weight (kg / km)	Min.Bending Radius (free movement) (mm)	Max. Resistance of Conductors at 20°C (ohm / km)
7x2,5	17,50	463	88	7,98
7x4	20,70	670	124	4,95
12x1,5	18,70	486	94	13,30
12x2,5	21,20	669	127	7,98
12x4	24,90	969	149	4,95
18x1,5	22,00	690	132	13,30
18x2,5	25,00	964	150	7,98
18x4	29,50	1407	177	4,95
24x1,5	25,70	894	154	13,30
24x2,5	29,40	1263	176	7,98
36x1,5	29,40	1245	176	13,30
36x2,5	33,80	1781	203	7,98





CABLE STRUCTURE

Conductor	Electrolytic annealed, class 5 stranded plain copper wires (tinned conductor on request)
Seperator	A suitable tape may be applied over the conductor
Insulation	EI4 type cross-linked elastomeric compound, EPR (EN 50363-1)
Inner Sheath	EM2 or EM3 type cross-linked elastomeric compound (EN 50363-2-1) <i>If outer sheath thickness is greater than 2,4 mm</i>
Outer Sheath	EM2 type cross-linked elastomeric compound (EN 50363-2-1)
Color	Black (other colors available on request)

MAIN CHARACTERISTICS

Construction	EN 50525-2-21, VDE 0285-2-21, IEC 60245-4
General Requirements	EN 50525-1, VDE 0285-525-1, IEC 60245-1
Guide to Use	EN 50565-1/2, VDE 0298-565-1
Electrical Tests	EN 50395, IEC 60245-2
Non-electrical Tests	EN 50396, IEC 60245-2
Conductor Resistance	IEC 60228, VDE 0295
Flame Retardant	IEC 60332-1-2, VDE 0482-332-1-2
Oil Resistant	EN 60811-404, VDE 0473-811-404
Water Resistance (AD8)	EN 50525-2-21, NF C15-100, EN 60529

OPERATING CHARACTERISTICS

Rated Voltage	450/750 V (U ₀ /U)
AC Test Voltage	2,5 kV
Operating Temperature	
<i>In Flexing Use</i>	-25°C to +60°C
<i>In Fixed Use</i>	-40°C to +90°C
Conductor Short-Circuit Temp.	200°C (Max. 5 sec)
Min. Installation Temp.	-25°C
Min. Bending Radius	EN 50565-1 Tab. 3
Current Carrying Capacities	VDE 0298-4 Tab.13, IEC 60364-5-52 Tab. B.52.12 & Tab. C.52.1

* It's allowed up to 1.000 V AC or DC using for fixed and protected installations.

APPLICATIONS

These rubber sheathed flexible cables are used as power and control cables in submersible pumps, agricultural and industrial workshops. This cable comply with AD8 classification and they are suitable for permanently submersion in water, 200 mt depth (20 bars) with maximum water temperature up to +40°C. Due to it's construction it can be used indoor, outdoor, wet, oily, damp places and explosion hazard areas.



FLAME RETARDANT



OIL RESISTANT



UV RESISTANT



WEATHER RESISTANT



WATER RESISTANT



SUBMERSION
200 MT (AD8)

Cross Section (mm ²)	Nominal Overall Diameter (mm)	Approximate Weight (kg / km)	Min.Bending Radius (free movement) (mm)	Max. Resistance of Conductors at 20°C (ohm / km)
1x1,5	6,00	50	24	13,30
1x2,5	6,40	63	26	7,98
1x4	7,30	85	29	4,95
1x6	8,10	111	32	3,30
1x10	10,20	179	41	1,91
1x16	11,00	238	44	1,21
1x25	13,80	365	69	0,78
1x35	15,30	475	77	0,554
1x50	17,80	657	89	0,386
1x70	19,40	864	97	0,272
1x95	22,10	1118	133	0,206
1x120	24,40	1404	146	0,161
1x150	16,60	1698	83	0,129
1x185	29,70	2100	178	0,106
1x240	32,60	2396	196	0,0801
1x300	35,60	3256	214	0,0641
1x400	40,90	4377	245	0,0486
1x500	45,60	5632	274	0,0384
1x630	49,30	6975	296	0,0287
2x1	8,40	94	34	19,50
2x1,5	9,30	117	37	13,30
2x2,5	10,60	160	42	7,98
2x4	12,20	221	61	4,95
2x6	13,60	288	68	3,30
2x10	19,20	555	96	1,91
2x16	21,00	717	126	1,21
2x25	26,70	1124	160	0,78
2x35	29,40	1421	176	0,554
2x50	34,40	1968	206	0,386
2x70	38,30	2564	230	0,272
2x95	43,70	3330	262	0,206
3x1	9,10	114	36	19,50

Cross Section (mm ²)	Nominal Overall Diameter (mm)	Approximate Weight (kg / km)	Min.Bending Radius (free movement) (mm)	Max. Resistance of Conductors at 20°C (ohm / km)
3x1,5	9,90	140	40	13,30
3x2,5	11,40	196	46	7,98
3x4	13,10	273	66	4,95
3x6	14,60	358	73	3,30
3x10	20,60	682	124	1,91
3x16	22,50	892	135	1,21
3x25	28,60	1390	172	0,78
3x35	31,70	1789	190	0,554
3x50	37,00	2474	222	0,386
3x70	40,90	3231	245	0,272
3x95	46,90	4220	281	0,206
3x120	51,60	5248	310	0,161
3x150	56,20	6319	337	0,129
3x185	62,30	7806	374	0,106
3x240	69,50	9963	417	0,0801
3x300	76,70	11894	460	0,0641
3x2,5+1,5	12,30	229	62	7,98
3x4+2,5	14,00	316	70	4,95
3x6+4	15,80	425	79	3,30
3x10+6	22,40	810	134	1,91
3x16+10	24,60	1070	148	1,21
3x25+16	31,40	1687	188	0,78
3x35+16	34,60	2114	208	0,554
3x50+25	40,60	2945	244	0,386
3x70+35	44,50	3820	267	0,272
3x95+50	51,00	5008	306	0,206
3x120+70	56,00	6267	336	0,161
3x150+70	60,90	7432	365	0,129
3x185+95	68,40	9296	410	0,106
3x240+120	76,50	11881	459	0,0801
3x300+150	84,40	14580	506	0,0641
4x1	10,10	143	40	19,50

Cross Section (mm ²)	Nominal Overall Diameter (mm)	Approximate Weight (kg / km)	Min.Bending Radius (free movement) (mm)	Max. Resistance of Conductors at 20°C (ohm / km)
4x1,5	11,00	175	44	13,30
4x2,5	12,60	244	63	7,98
4x4	14,50	342	73	4,95
4x6	16,30	456	82	3,30
4x10	22,60	845	136	1,91
4x16	24,70	1114	148	1,21
4x25	31,80	1760	191	0,78
4x35	35,20	2265	211	0,554
4x50	41,10	3136	247	0,386
4x70	45,00	4098	270	0,272
4x95	52,00	5393	312	0,206
4x120	56,80	6657	341	0,161
4x150	62,20	8067	373	0,129
4x185	69,70	10030	418	0,106
4x240	77,60	12786	466	0,0801
4x300	85,80	15799	515	0,0641
5x1	11,10	170	44	19,50
5x1,5	12,10	208	61	13,30
5x2,5	13,80	290	69	7,98
5x4	16,10	415	81	4,95
5x6	18,10	554	91	3,30
5x10	24,9	1033	149	1,91
5x16	27,4	1377	164	1,21
5x25	35,4	2183	212	0,78
5x35	38,9	2788	233	0,554
5x50	45,8	3902	275	0,386
5x70	50,2	5113	301	0,272
5x95	57,8	6693	347	0,206
6x1,5	14,4	289	72	13,30
6x2,5	16,2	1123	81	7,98
6x4	18,7	551	94	4,95
7x1,5	15,4	337	77	13,30

Cross Section (mm ²)	Nominal Overall Diameter (mm)	Approximate Weight (kg / km)	Min.Bending Radius (free movement) (mm)	Max. Resistance of Conductors at 20°C (ohm / km)
7x2,5	17,5	463	88	7,98
7x4	20,7	670	124	4,95
12x1,5	18,7	486	94	13,30
12x2,5	21,2	669	127	7,98
12x4	24,9	969	149	4,95
18x1,5	22	690	132	13,30
18x2,5	25	964	150	7,98
18x4	29,5	1407	177	4,95
24x1,5	25,7	894	154	13,30
24x2,5	29,4	1263	176	7,98
36x1,5	29,4	1245	176	13,30
36x2,5	33,8	1781	203	7,98

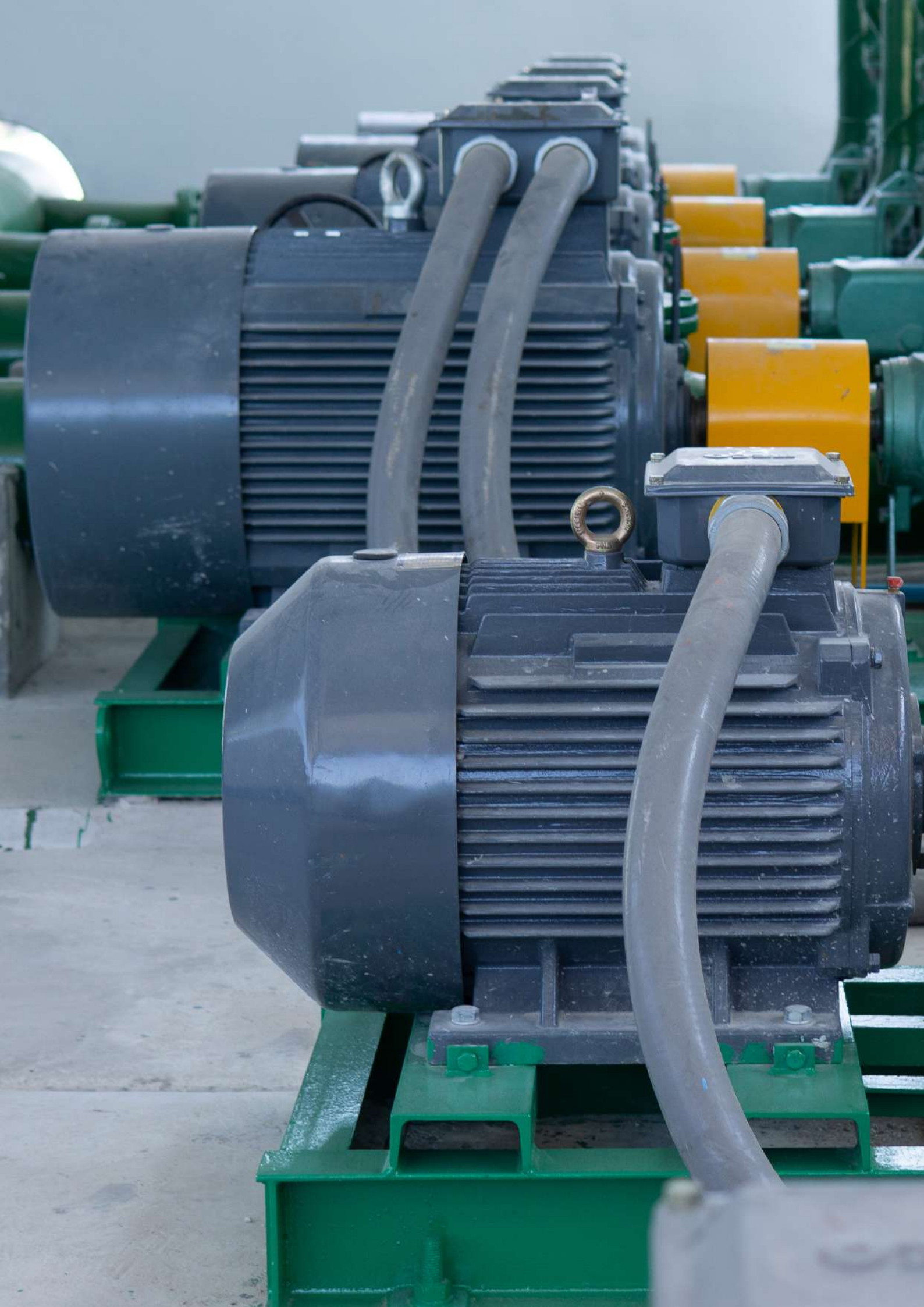



CABLE STRUCTURE

Conductor	Electrolytic annealed, class 5 stranded plain or tinned copper wires depends on request
Seperator	A suitable tape may be applied over the conductor
Insulation	EI4 type cross-linked elastomeric compound, EPR (EN 50363-1)
Inner Sheath	EM2 or EM3 type cross-linked elastomeric compound (EN 50363-2-1) If outer sheath thickness is greater than 2,4 mm
Outer Sheath	Special water resistant elastomeric compound (Based on EN 50363-2-1)
Color	Black (other colors available on request)

MAIN CHARACTERISTICS

Construction	Based on EN 50525-2-21, VDE 0285-2-21, IEC 60245-4
General Requirements	EN 50525-1, VDE 0285-525-1, IEC 60245-1
Guide to Use	EN 50565-1/2, VDE 0298-565-1
Electrical Tests	EN 50395, IEC 60245-2
Non-electrical Tests	EN 50396, IEC 60245-2
Conductor Resistance	IEC 60228, VDE 0295
Flame Retardant	IEC 60332-1-2, VDE 0482-332-1-2
Oil Resistant	EN 60811-404, VDE 0473-811-404
Ozone Resistant	EN 60811-403
Water Resistant (AD 8)	EN 50525-2-21, NF C15-100, EN 60529

OPERATING CHARACTERISTICS

Rated Voltage	450/750 V (U _o /U)
AC Test Voltage	2,5 kV
Operating Temperature	
<i>In Flexing Use</i>	-25°C to +60°C
<i>In Fixed Use</i>	-40°C to +90°C
Conductor Short-Circuit Temp.	200°C (Max. 5 sec.)
Min. Installation Temp.	-25°C
Min. Bending Radius	Based on EN 50565-1 Tab. 3
Current Carrying Capacities	Based on VDE 0298-4 Tab.13, IEC 60364-5-52 Tab. B.52.12 & Tab. C.52.1

APPLICATIONS

These rubber sheathed flexible cables are used as power and control cables in submersible pumps, agricultural and industrial workshops. This cable comply with AD8 classification and they are suitable for permanently submersion in water, 200 mt depth (20 bars) with maximum water temperature up to +40°C. Due to it's construction it can be used indoor, outdoor, wet, oily, damp places and explosion hazard areas.



Cross Section (mm ²)	Nominal Overall Diameter (mm)	Approximate Weight (kg / km)	Min.Bending Radius (free movement) (mm)	Max. Resistance of Conductors at 20°C (ohm / km)
3x1,5	10,80	163	43	13,30
4G2,5	17,30	405	87	7,98
4G4	19,50	565	98	4,95
4G6	21,00	752	126	3,30
4G10	22,50	833	135	1,91
4G16	26,00	1160	156	1,21
3x35+16+3x1,5	39,00	2522	195	0,57
4G1,5+3x1,5	16,50	380	83	13,30
4G2,5+3x1,5	20,00	543	120	7,98
4G6+2x1,5	22,00	763	132	3,30
4G10+3x1,5	23,00	865	138	1,91
7G2,5+3x1,5	22,00	678	132	7,98
7G4+3x1,5	26,00	1077	156	4,95
7G6+3x1,5	26,00	1154	156	3,30
7G25+3x1,5	38,00	2770	228	0,80



CABLE STRUCTURE

Conductor	Electrolytic annealed, class 5 stranded plain copper wires (tinned conductor on request)
Separator	A suitable tape may be applied over the conductor
Insulation	EI7 type cross-linked elastomeric compound (EN 50363-1)
Inner Sheath	EM6 or EM7 type cross-linked elastomeric compound (EN 50363-2-1) <i>If outer sheath thickness is greater than 2,4 mm</i>
Outer Sheath	EM7 type cross-linked elastomeric compound (EN 50363-2-1)
Color	Black (other colors available on request)

MAIN CHARACTERISTICS

Construction	EN 50525-2-21, VDE 0285-2-21, IEC 60245-4
General Requirements	EN 50525-1, VDE 0285-525-1, IEC 60245-1
Guide to Use	EN 50565-1/2, VDE 0298-565-1
Electrical Tests	EN 50395, IEC 60245-2
Non-electrical Tests	EN 50396, IEC 60245-2
Conductor Resistance	IEC 60228, VDE 0295
Flame Retardant	IEC 60332-1-2, VDE 0482-332-1-2
Oil Resistant	EN 60811-404, VDE 0473-811-404

OPERATING CHARACTERISTICS

Rated Voltage	450/750 V (U ₀ /U)
AC Test Voltage	2,5 kV
Operating Temperature	
<i>In Flexing Use</i>	-25°C to +90°C
<i>In Fixed Use</i>	-40°C to +90°C
Conductor Short-Circuit Temp.	250°C (Max. 5 sec)
Min. Installation Temp.	-25°C
Min. Bending Radius	EN 50565-1 Tab. 3
Current Carrying Capacities	VDE 0298-4 Tab.13, IEC 60364-5-52 Tab. B.52.12 & Tab. C.52.1

* It's allowed up to 1.000 V AC or DC using for fixed and protected installations.

APPLICATIONS

These heat resistant rubber sheathed flexible cables are used as power and control cables in wind turbines, agricultural and industrial workshops. They are suitable for heavy duty applications and resistant to both mechanical abrasion and high temperatures. Due to its construction it can be used indoor, outdoor, wet, oily, damp places and explosion hazard areas.



HEAT RESISTANT



FLAME RETARDANT



OIL RESISTANT



UV RESISTANT



WEATHER RESISTANT

Cross Section (mm ²)	Nominal Overall Diameter (mm)	Approximate Weight (kg / km)	Min.Bending Radius (free movement) (mm)	Max. Resistance of Conductors at 20°C (ohm / km)
1x1,5	6,00	50	24	13,30
1x2,5	6,40	63	26	7,98
1x4	7,30	85	29	4,95
1x6	8,10	111	32	3,30
1x10	10,20	179	41	1,91
1x16	11,00	238	44	1,21
1x25	13,80	365	69	0,78
1x35	15,30	475	77	0,554
1x50	17,80	657	89	0,386
1x70	19,40	864	97	0,272
1x95	22,10	1118	133	0,206
1x120	24,40	1404	146	0,161
1x150	16,60	1698	83	0,129
1x185	29,70	2100	178	0,106
1x240	32,60	2396	196	0,0801
1x300	35,60	3256	214	0,0641
1x400	40,90	4377	245	0,0486
1x500	45,60	5632	274	0,0384
1x630	49,30	6975	296	0,0287
2x1	8,40	94	34	19,50
2x1,5	9,30	117	37	13,30
2x2,5	10,60	160	42	7,98
2x4	12,20	221	61	4,95
2x6	13,60	288	68	3,30
2x10	19,20	555	96	1,91
2x16	21,00	717	126	1,21
2x25	26,70	1124	160	0,78
2x35	29,40	1421	176	0,554
2x50	34,40	1968	206	0,386
2x70	38,30	2564	230	0,272
2x95	43,70	3330	262	0,206
3x1	9,10	114	36	19,50

Cross Section (mm ²)	Nominal Overall Diameter (mm)	Approximate Weight (kg / km)	Min.Bending Radius (free movement) (mm)	Max. Resistance of Conductors at 20°C (ohm / km)
3x1,5	9,90	140	40	13,30
3x2,5	11,40	196	46	7,98
3x4	13,10	273	66	4,95
3x6	14,60	358	73	3,30
3x10	20,60	682	124	1,91
3x16	22,50	892	135	1,21
3x25	28,60	1390	172	0,78
3x35	31,70	1789	190	0,554
3x50	37,00	2474	222	0,386
3x70	40,90	3231	245	0,272
3x95	46,90	4220	281	0,206
3x120	51,60	5248	310	0,161
3x150	56,20	6319	337	0,129
3x185	62,30	7806	374	0,106
3x240	69,50	9963	417	0,0801
3x300	76,70	11894	460	0,0641
3x2,5+1,5	12,30	229	62	7,98
3x4+2,5	14,00	316	70	4,95
3x6+4	15,80	425	79	3,30
3x10+6	22,40	810	134	1,91
3x16+10	24,60	1070	148	1,21
3x25+16	31,40	1687	188	0,78
3x35+16	34,60	2114	208	0,554
3x50+25	40,60	2945	244	0,386
3x70+35	44,50	3820	267	0,272
3x95+50	51,00	5008	306	0,206
3x120+70	56,00	6267	336	0,161
3x150+70	60,90	7432	365	0,129
3x185+95	68,40	9296	410	0,106
3x240+120	76,50	11881	459	0,0801
3x300+150	84,40	14580	506	0,0641
4x1	10,10	143	40	19,50

Cross Section (mm ²)	Nominal Overall Diameter (mm)	Approximate Weight (kg / km)	Min.Bending Radius (free movement) (mm)	Max. Resistance of Conductors at 20°C (ohm / km)
4x1,5	11,00	175	44	13,30
4x2,5	12,60	244	63	7,98
4x4	14,50	342	73	4,95
4x6	16,30	456	82	3,30
4x10	22,60	845	136	1,91
4x16	24,70	1114	148	1,21
4x25	31,80	1760	191	0,78
4x35	35,20	2265	211	0,554
4x50	41,10	3136	247	0,386
4x70	45,00	4098	270	0,272
4x95	52,00	5393	312	0,206
4x120	56,80	6657	341	0,161
4x150	62,20	8067	373	0,129
4x185	69,70	10030	418	0,106
4x240	77,60	12786	466	0,0801
4x300	85,80	15799	515	0,0641
5x1	11,10	170	44	19,50
5x1,5	12,10	208	61	13,30
5x2,5	13,80	290	69	7,98
5x4	16,10	415	81	4,95
5x6	18,10	554	91	3,30
5x10	24,9	1033	149	1,91
5x16	27,4	1377	164	1,21
5x25	35,4	2183	212	0,78
5x35	38,9	2788	233	0,554
5x50	45,8	3902	275	0,386
5x70	50,2	5113	301	0,272
5x95	57,8	6693	347	0,206
6x1,5	14,4	289	72	13,30
6x2,5	16,2	1123	81	7,98
6x4	18,7	551	94	4,95
7x1,5	15,4	337	77	13,30

H07BN4-F (638 TQ)

Heat Resistant
Rubber Sheathed Flex Power Cable

Cross Section (mm ²)	Nominal Overall Diameter (mm)	Approximate Weight (kg / km)	Min.Bending Radius (free movement) (mm)	Max. Resistance of Conductors at 20°C (ohm / km)
7x2,5	17,5	463	88	7,98
7x4	20,7	670	124	4,95
12x1,5	18,7	486	94	13,30
12x2,5	21,2	669	127	7,98
12x4	24,9	969	149	4,95
18x1,5	22	690	132	13,30
18x2,5	25	964	150	7,98
18x4	29,5	1407	177	4,95
24x1,5	25,7	894	154	13,30
24x2,5	29,4	1263	176	7,98
36x1,5	29,4	1245	176	13,30
36x2,5	33,8	1781	203	7,98





CABLE STRUCTURE

Conductor	Electrolytic annealed, class 5 stranded plain copper wires (tinned conductor on request)
Separator	A suitable tape may be applied over the conductor
Insulation	EI4 type cross-linked elastomeric compound, EPR (EN 50363-1)
Inner Sheath	EM2 or EM3 type cross-linked elastomeric compound (EN 50363-2-1) <i>If outer sheath thickness is greater than 2,4 mm</i>
Screen	Tinned copper wire braiding
Outer Sheath	EM2 type cross-linked elastomeric compound (EN 50363-2-1)
Color	Black (other colors available on request)

MAIN CHARACTERISTICS

Construction	Based on EN 50525-2-21, VDE 0285-2-21, IEC 60245-4
General Requirements	EN 50525-1, VDE 0285-525-1, IEC 60245-1
Guide to Use	EN 50565-1/2, VDE 0298-565-1
Electrical Tests	EN 50395, IEC 60245-2
Non-electrical Tests	EN 50396, IEC 60245-2
Conductor Resistance	IEC 60228, VDE 0295
Flame Retardant	IEC 60332-1-2, VDE 0482-332-1-2
Oil Resistant	EN 60811-404, VDE 0473-811-404

OPERATING CHARACTERISTICS

Rated Voltage	450/750 V (U ₀ /U)
AC Test Voltage	2,5 kV
Operating Temperature	
<i>In Flexing Use</i>	-25°C to +60°C
<i>In Fixed Use</i>	-40°C to +90°C
Conductor Short-Circuit Temp.	200°C (Max. 5 sec)
Min. Installation Temp.	-25°C
Min. Bending Radius	Based on EN 50565-1 Tab. 3
Current Carrying Capacities	VDE 0298-4 Tab.13, IEC 60364-5-52 Tab. B.52.12 & Tab. C.52.1

* It's allowed up to 1.000 V AC or DC using for fixed and protected installations.

APPLICATIONS

These shielded, rubber sheathed flexible cables are used as power and control and signalling cables in open-built plants, industry works, electrical tools and mobile equipments under heavy conditions and medium mechanical stress. It's shielded for against electromagnetic disturbances. Due to it's construction it can be used indoor, outdoor, wet, oily, damp places and explosion hazard areas.



Cross Section (mm ²)	Nominal Overall Diameter (mm)	Approximate Weight (kg / km)	Min.Bending Radius (free movement) (mm)	Max. Resistance of Conductors at 20°C (ohm / km)
1x16	12,50	295	75	1,21
1x25	14,90	423	89	0,78
1x35	16,20	539	97	0,554
1x50	18,50	722	111	0,386
1x70	20,80	975	125	0,272
1x95	23,40	1.257	140	0,206
1x120	25,50	1.545	153	0,161
1x150	27,70	1.879	166	0,129
1x185	30,40	2.255	182	0,106
1x240	34,10	2.960	205	0,0801
1x300	37,10	3579	223	0,0641
2x1,5	12,50	216	75	13,30
2x2,5	14,10	280	85	7,98
2x4	15,70	358	94	4,95
2x6	17,20	442	103	3,30
2x10	20,60	660	124	1,91
2x16	23,00	862	138	1,21
2x25	28,10	1.277	169	0,78
2x35	30,40	1.576	182	0,554
3x1	12,30	211	74	19,50
3x1,5	13,10	243	79	13,30
3x2,5	14,90	323	89	7,98
3x4	16,60	418	100	4,95
3x6	18,20	523	109	3,30
3x10	22,20	806	133	1,91
3x16	24,60	1.054	148	1,21
3x25	30,00	1.558	180	0,78
3x35	32,90	1.997	197	0,554
3x50	37,70	2.669	226	0,386
3x70	43,20	3.618	259	0,272
3x95	48,90	4702	293	0,206
3x120	54,00	5853	324	0,161

Cross Section (mm ²)	Nominal Overall Diameter (mm)	Approximate Weight (kg / km)	Min.Bending Radius (free movement) (mm)	Max. Resistance of Conductors at 20°C (ohm / km)
4x1	13,30	248	80	19,50
4x1,5	14,20	289	85	13,30
4x2,5	16,10	383	97	7,98
4x4	18,00	503	108	4,95
4x6	19,90	637	119	3,30
4x10	24,40	992	146	1,91
4x16	26,80	1.294	161	1,21
4x25	33,40	1.979	200	0,78
4x35	36,30	2.495	218	0,554
4x50	41,70	3.356	250	0,386
4x70	48,40	4.674	290	0,272
4x95	54,60	5.992	328	0,206
4x120	60,30	7.511	362	0,161
5x1,5	15,30	337	92	13,30
5x2,5	17,40	451	104	7,98
5x4	19,80	609	119	4,95
5x6	21,40	758	128	3,30
5x10	26,30	1.173	158	1,91
5x16	39,60	1.582	238	1,21
5x25	37,00	2430	222	0,78
5x35	40,00	3049	240	0,554
5x50	46,30	4143	278	0,386
5x70	53,10	5740	319	0,272
5x95	60,20	7440	361	0,206
7x1,5	16,80	414	101	13,30
7x2,5	19,60	588	118	7,98
7x4	22,60	811	136	4,95
12x1,5	20,10	591	121	13,30
12x2,5	23,20	815	139	7,98
18x1,5	23,40	815	140	13,30
18x2,5	27,20	1.143	163	7,98
24x1,5	27,10	1.041	163	13,30

07RC4N-F

Rubber Sheathed Screened Flex
Power Cable

Cross Section (mm ²)	Nominal Overall Diameter (mm)	Approximate Weight (kg / km)	Min.Bending Radius (free movement) (mm)	Max. Resistance of Conductors at 20°C (ohm / km)
24x2,5	31,90	1.507	191	7,98
36x1,5	31,00	1.443	186	13,30
36x2,5	36,50	2.079	219	7,98



CABLE STRUCTURE

Conductor	Electrolytic annealed, class 5 stranded plain copper wires (tinned conductor on request)
Seperator	A suitable tape may be applied over the conductor
Insulation	EI4 type cross-linked elastomeric compound, EPR (EN 50363-1)
Outer Sheath	EM2 type cross-linked elastomeric compound (EN 50363-2-1)
Color	Black

MAIN CHARACTERISTICS

Construction	Based on EN 50525-2-21, VDE 0285-2-21, IEC 60245-4
General Requirements	Based on EN 50525-1, VDE 0285-525-1, IEC 60245-1
Guide to Use	Based on EN 50565-1/2, VDE 0298-565-1
Electrical Tests	Based on EN 50395, IEC 60245-2
Non-electrical Tests	Based on EN 50396, IEC 60245-2
Conductor Resistance	Based on IEC 60228, VDE 0295
Flame Retardant	Based on IEC 60332-1, VDE 0482-332-1-2
Oil Resistant	Based on IEC 60811-4-04, VDE 0473-811-404

OPERATING CHARACTERISTICS

Rated Voltage	450/750 V (U ₀ /U)
AC Test Voltage	2,5 kV
Operating Temperature	
<i>In Flexing Use</i>	-25°C to +60°C
<i>In Fixed Use</i>	-40°C to +90°C
Conductor Short-Circuit Temp.	200°C (Max. 5 sec)
Min. Installation Temp.	-25°C
Min. Bending Radius	Based on EN 50565-1 Tab. 3
Current Carrying Capacities	Based on VDE 0298-4 Tab.13, IEC 60364-5-52 Tab. B.52.12

APPLICATIONS

These rubber sheathed flat flexible cables are mostly used as power and control cables for lifts, cranes, elevators and festoon applications. It's flat form make it require smaller bending radius, good space utilization and highly flexible. Due to it's construction it can be used indoor, outdoor, wet, oily, damp places and explosion hazard areas.



Cross Section (mm ²)	Nominal Overall Diameter (mm)	Approximate Weight (kg / km)	Min.Bending Radius (free movement) (mm)	Max. Resistance of Conductors at 20°C (ohm / km)
3x1,5	5,60 x 12,70	137	22	13,30
3x2,5	6,80 x 15,90	213	27	7,98
3x4	7,90 x 18,90	307	32	4,95
3x6	8,60 x 22x40	411	34	3,30
3x10	10,10 x 26,90	605	40	1,91
3x16	11,80 x 30,60	859	47	1,21
3x25	14,00 x 36,70	1224	70	0,78
3x35	15,70 x 41,20	1608	79	0,554
3x50	17,90 x 48,00	2191	90	0,386
3x70	21,20 x 55,50	3098	127	0,272
3x95	23,10 x 60,00	3786	139	0,206
3x120	25,80 x 67,00	4877	155	0,161
3x150	28,40 x 73,20	5990	170	0,129
3x185	31,50 x 80,90	7725	189	0,106
3x240	35,60 x 91,60	9580	214	0,0801
4x1,5	5,90 x 17,00	191	24	13,30
4x2,5	6,50 x 20,00	263	26	7,98
4x4	8,00 x 23,00	385	32	4,95
4x6	8,10 x 25,00	463	32	3,30
4x10	10,00 x 33,20	760	40	1,91
4x16	12,10 x 38,60	1123	61	1,21
4x25	14,50 x 47,60	1639	73	0,78
4x35	16,30 x 53,80	2167	82	0,554
4x50	18,20 x 62,00	2894	91	0,386
4x70	20,50 x 70,00	3919	123	0,272
4x95	23,10 x 78,30	4986	139	0,206
4x120	24,50 x 86,00	6049	147	0,161
4x150	27,00 x 95,90	7442	162	0,129
4x185	27,60 x 116,10	9175	166	0,106
4x240	35,60 x 119,60	12630	214	0,0801
5x1,5	5,60 x 20,00	217	22	13,30
5x2,5	6,60 x 23,00	311	26	7,98

Cross Section (mm ²)	Nominal Overall Diameter (mm)	Approximate Weight (kg / km)	Min.Bending Radius (free movement) (mm)	Max. Resistance of Conductors at 20°C (ohm / km)
5x4	7,90 x 27,50	461	32	4,95
5x6	8,40 x 30,00	576	42	3,30
5x10	9,80 x 39,30	902	49	1,91
5x16	11,40 x 43,40	1263	57	1,21
5x25	14,40 x 56,80	1984	72	0,78
5x35	15,50 x 62,30	2508	78	0,554
7x1,5	5,60 x 27,60	301	22	13,30
7x2,5	6,80 x 33,70	463	27	7,98
7x4	8,00 x 40,40	675	32	4,95
7x6	8,50 x 43,10	828	34	3,30
7x10	10,00 x 53,70	1259	40	1,91
7x16	13,00 x 65,80	2025	65	1,21
8x1,5	6,20 x 31,00	369	25	13,30
8x2,5	6,40 x 36,00	478	26	7,98
10x1,5	6,30 x 38,40	463	25	13,30
10x2,5	7,20 x 42,60	628	29	7,98
12x1,5	5,80 x 46,90	527	23	13,30
12x2,5	7,40 x 58,00	850	30	7,98
14x1,5	6,80 x 54,50	698	27	13,30
14x2,5	7,70 x 66,90	1015	31	7,98
16x1,5	6,80 x 64,00	817	27	13,30
16x2,5	7,70 x 71,80	1068	31	7,98
24x1,5	6,60 x 92,50	1158	26	13,30
24x2,5	6,00 x 96,30	1257	24	7,98





(Single cores only)



CABLE STRUCTURE

Conductor	Electrolytic annealed, class 5 stranded plain copper wires (tinned conductor on request)
Separator	A suitable tape may be applied over the conductor
Insulation	EI8 type cross-linked elastomeric compound (EN 50363-5)
Inner Sheath	EM8 or EM10 type elastomer compound. <i>If outer sheath thickness is greater than 2,4 mm</i>
Outer Sheath	EM8 type cross-linked elastomeric compound (EN 50363-6)
Color	Black (other colors available on request)

MAIN CHARACTERISTICS

Construction	EN 50525-3-21, VDE 0285-3-21, IEC 60245-4
General Requirements	EN 50525-1, VDE 0285-525-1, IEC 60245-1
Guide to Use	EN 50565-1/2, VDE 0298-565-1
Electrical Tests	EN 50395, IEC 60245-2
Non-electrical Tests	EN 50396, IEC 60245-2
Conductor Resistance	IEC 60228, VDE 0295
Halogen Content	EN 50363-5/6, EN 60574-1
Flame Retardant	IEC 60332-1-2, VDE 0482-332-1-2, IEC 60332-3-24
Oil Resistant	EN 60811-404, VDE 0473-811-404

OPERATING CHARACTERISTICS

Rated Voltage	450/750 V (U ₀ /U)
AC Test Voltage	2,5 kV
Operating Temperature <i>(Without mechanical shocks)</i>	
<i>In Flexing Use</i>	-5°C to +70°C
<i>In Fixed Use</i>	-20°C to +90°C
Conductor Short-Circuit Temp.	250°C (Max. 5 sec)
Min. Installation Temp.	-5°C
Min. Bending Radius	EN 50565-1 Tab. 3
Current Carrying Capacities	VDE 0298-4 Tab.13, IEC 60364-5-52 Tab. B.52.12 & Tab. C.52.1

* It's allowed up to 1.000 V AC or DC using for fixed and protected installations.

APPLICATIONS

These halogen-free flexible cables are used as power and control cables temporary indoor and permanent outdoor applications. It consist low grade smoke and corrosive gases and suitable to use for heavy conditions and medium mechanical stress. Due to it's construction it can be used wet, oily, damp places and explosion hazard areas.



FLAME RETARDANT



HALOGEN-FREE



LOW SMOKE



OIL RESISTANT



UV RESISTANT

Cross Section (mm ²)	Nominal Overall Diameter (mm)	Approximate Weight (kg / km)	Min.Bending Radius (free movement) (mm)	Max. Resistance of Conductors at 20°C (ohm / km)
1x1,5	6,20	56	25	13,30
1x2,5	6,80	71	27	7,98
1x4	7,70	97	31	4,95
1x6	8,40	123	34	3,30
1x10	10,30	191	41	1,91
1x16	11,50	260	46	1,21
1x25	14,20	388	71	0,78
1x35	15,50	502	78	0,554
1x50	17,80	680	89	0,386
1x70	20,10	927	121	0,272
1x95	22,50	1.185	135	0,206
1x120	24,60	1.470	148	0,161
1x150	26,80	1.797	161	0,129
1x185	29,50	2.167	177	0,106
1x240	33,00	2833	198	0,0801
1x300	36,00	3442	216	0,0641
1x400	41,30	4459	248	0,0486
1x500	44,60	5748	268	0,0384
1x630	47,80	7178	287	0,0287
2x1	8,40	100	34	19,50
2x1,5	9,40	128	38	13,30
2x2,5	11,00	181	44	7,98
2x4	12,60	248	63	4,95
2x6	14,00	318	70	3,30
2x10	19,60	601	98	1,91
2x16	22,00	799	132	1,21
2x25	26,80	1.184	161	0,78
3x1	9,10	121	36	19,50
3x1,5	10,10	153	40	13,30
3x2,5	11,80	217	47	7,98
3x4	13,50	300	68	4,95
3x6	15,00	390	75	3,30

Cross Section (mm ²)	Nominal Overall Diameter (mm)	Approximate Weight (kg / km)	Min.Bending Radius (free movement) (mm)	Max. Resistance of Conductors at 20°C (ohm / km)
3x10	21,10	731	127	1,91
3x16	23,60	980	142	1,21
3x25	29,20	1.483	175	0,78
3x35	31,70	1.873	190	0,554
3x50	36,60	2.546	220	0,386
3x70	41,30	3.429	248	0,272
3x95	46,60	4.413	280	0,206
3x120	50,90	5.430	305	0,161
3x150	55,50	6.614	333	0,129
3x185	61,30	8.021	368	0,106
3x240	69,80	10627	419	0,0801
3x300	77,10	13055	463	0,0641
4x1	10,10	150	40	19,50
4x1,5	11,20	191	45	13,30
4x2,5	13,00	269	65	7,98
4x4	14,90	374	75	4,95
4x6	16,70	493	84	3,30
4x10	23,00	894	138	1,91
4x16	25,80	1.211	155	1,21
4x25	32,40	1.867	194	0,78
4x35	35,10	2.361	211	0,554
4x50	40,50	3.206	243	0,386
4x70	45,90	4.352	275	0,272
4x95	51,80	5.646	311	0,206
4x120	56,50	6.888	339	0,161
4x150	61,80	8.424	371	0,129
4x185	68,40	10.231	410	0,106
4x240	77,80	13535	467	0,0801
4x300	86,00	16633	516	0,0641
5x1	11,10	182	44	19,50
5x1,5	12,40	235	62	13,30
5x2,5	14,40	331	72	7,98

Cross Section (mm ²)	Nominal Overall Diameter (mm)	Approximate Weight (kg / km)	Min.Bending Radius (free movement) (mm)	Max. Resistance of Conductors at 20°C (ohm / km)
5x4	16,70	469	84	4,95
5x6	19,00	622	95	3,30
5x10	25,30	1.091	152	1,91
5x16	28,60	1496	172	1,21
5x25	25,90	2302	155	0,78
6x1,5	14,60	317	73	13,30
6x2,5	16,80	438	84	7,98
6x4	19,30	609	97	4,95
7x1,5	14,60	327	73	13,30
7x2,5	16,80	454	84	7,98
7x4	19,30	635	97	4,95
12x1,5	19,20	531	96	13,30
12x2,5	22,10	739	133	7,98
12x4	25,80	1.061	155	4,95
18x1,5	22,40	742	134	13,30
18x2,5	26,00	1.050	156	7,98
18x4	30,30	1507	182	4,95
24x1,5	26,20	967	157	13,30
24x2,5	30,60	1.382	184	7,98
36x1,5	30,00	1.344	180	13,30
36x2,5	35,20	1.944	211	7,98



CABLE STRUCTURE

Conductor	Electrolytic annealed, class 5 stranded plain copper wires (tinned conductor on request)
Insulation	EI5 type cross-linked elastomeric compound, (EN 50363-5)
Color	All colors available

MAIN CHARACTERISTICS

Construction	EN 50525-3-41, VDE 0285-525-3-41, IEC 60245-4
General Requirements	EN 50525-1, VDE 0285-525-1, IEC 60245-1
Guide to Use	EN 50565-1/2, VDE 0298-565-1
Electrical Tests	EN 50395, IEC 60245-2
Non-electrical Tests	EN 50396, IEC 60245-2
Conductor Resistance	IEC 60228, VDE 0295
Halogen Content	EN 50363 - 5, IEC 60764 - 1
Smoke Emission	IEC 61034 /1 - 2, EN 50268 /1 - 2
Flame Retardant	IEC 60332 - 1 - 2, VDE 0482 - 332 - 1 - 2

OPERATING CHARACTERISTICS

Rated Voltage	H05Z-K 300/500V - H07Z-K 450/750V (U ₀ /U)
AC Test Voltage	2,5 kV
Operating Temperature	-40°C to +90°C
Conductor Short-Circuit Temp.	250°C (Max. 5 sec.)
Min. Installation Temp.	-5°C
Min. Bending Radius	EN 50565-1 Tab. 3
Current Carrying Capacities	VDE 0298-4 Tab.5 & 11, IEC 60364-5-52 Tab. B.52.12

APPLICATIONS

These halogen-free cables are used in internal installations only in dry and clean environments. Due to its characteristics they are flame retardant and self extinguishing and produce no corrosive gases.



H05Z-K

Cross Section (mm ²)	Nominal Overall Diameter (mm)	Approximate Weight (kg / km)	Min.Bending Radius (fixed installation) (mm)	Max. Resistance of Conductors at 20°C (ohm / km)
1x0,50	2,10	9	6	39,00
1x0,75	2,30	12	7	26,00
1x1	2,50	14	8	19,50

H07Z-K

Cross Section (mm ²)	Nominal Overall Diameter (mm)	Approximate Weight (kg / km)	Min.Bending Radius (fixed installation) (mm)	Max. Resistance of Conductors at 20°C (ohm / km)
1x1,5	2,90	19	9	13,30
1x2,5	3,55	30	11	7,98
1x4	4,05	45	12	4,95
1x6	4,60	63	14	3,30
1x10	6,10	108	18	1,91
1x16	7,10	160	21	1,21
1x25	9,20	249	28	0,78
1x35	10,10	338	30	0,554
1x50	12,00	474	36	0,386
1x70	13,90	677	56	0,272
1x95	15,90	884	64	0,206
1x120	17,60	1117	70	0,161
1x150	19,40	1388	78	0,129
1x185	21,70	1689	87	0,106
1x240	25,00	2278	100	0,0801

* The overall dimensions of cables have been calculated in accordance with EN 60719



CABLE STRUCTURE

Conductor	Electrolytic annealed, class 5 stranded plain copper wires (tinned conductor on request)
Separator	A suitable tape may be applied over the conductor
Insulation	EI6 type cross-linked elastomeric compound, EPR (EN 50363-1)
Outer Sheath	Thermoplastic polyurethane of type TPU (EN 50363-10-2)
Color	Orange (other colors available on request)

MAIN CHARACTERISTICS

Construction	EN 50525-2-21, VDE 0285-525-2-21, IEC 60245-4
General Requirements	EN 50525-1, VDE 0285-525-1, IEC 60245-1
Guide to Use	EN 50565-1/2, VDE 0298-565-1
Electrical Tests	EN 50395, IEC 60245-2
Non-electrical Tests	EN 50396, IEC 60245-2
Conductor Resistance	IEC 60228, VDE 0295
Oil Resistant	EN 60811-404, VDE 0473-811-404

OPERATING CHARACTERISTICS

Rated Voltage	450/750 V (U ₀ /U)
AC Test Voltage	2,5 kV
Operating Temperature	
<i>In Flexing Use</i>	-40°C to +90°C
<i>In Fixed Use</i>	-50°C to +90°C
Conductor Short-Circuit Temp.	250°C (Max. 5 sec)
Min. Installation Temp.	-40°C
Min. Bending Radius	EN 50565-1 Tab. 3
Current Carrying Capacities	VDE 0298-4 Tab.13 , IEC 60364-5-52 Tab. B.52.12 & Tab. C.52.1

* It's allowed up to 1.000 V AC or DC using for fixed and protected installations.

APPLICATIONS

These cables are flexible power cords of electrical tools and equipments, agricultural machines and for sea vessels power connection in marinas and shipyards. Thanks to it's construction it is suitable for cold storage applications and heating installations if there is no risk of contact with hot parts. Polyurethane outer sheath is robust and flexible that is resistant to medium mechanical stress, tear, abrasion and as well to oil, wet environments and UV too.



Cross Section (mm ²)	Nominal Overall Diameter (mm)	Approximate Weight (kg / km)	Min.Bending Radius (free movement) (mm)	Max. Resistance of Conductors at 20°C (ohm / km)
2x1	7,60	66	30	19,50
2x1,5	8,30	82	33	13,30
2x2,5	9,40	113	38	7,98
2x4	11,00	164	44	4,95
2x6	12,20	215	40	3,30
2x10	17,00	399	32	1,91
2x16	18,60	532	23	1,21
3x1	8,10	80	32	19,50
3x1,5	8,70	97	35	13,30
3x2,5	10,00	139	40	7,98
3x4	11,70	203	47	4,95
3x6	13,20	276	44	3,30
3x10	18,30	504	35	1,91
3x16	20,10	688	24	1,21
4x1	9,10	102	36	19,50
4x1,5	9,80	124	39	13,30
4x2,5	11,20	178	45	7,98
4x4	13,10	260	65	4,95
4x6	14,70	353	49	3,30
4x10	20,20	636	39	1,91
4x16	22,10	869	27	1,21
5x1	10,10	122	40	19,50
5x1,5	11,00	149	44	13,30
5x2,5	12,40	215	99	7,98
5x4	14,50	315	72	4,95
5x6	16,30	430	54	3,30
5x10	22,30	769	43	1,91
5x16	24,60	1064	30	1,21

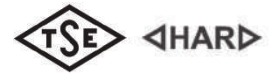

CABLE STRUCTURE

Conductor	Electrolytic annealed, class 6 stranded plain copper wires (tinned conductor on request)
Insulation	EI4 type cross-linked elastomeric compound, EPR (EN 50363-1)
Bedding	Textile yarns
Sheath	Textile yarn braiding
Color	Grey/White, Blue/White or Black

MAIN CHARACTERISTICS

Construction	EN 50525-2-22, VDE 0285-525-2-22, IEC 60245-8
General Requirements	EN 50525-1, VDE 0285-525-1, IEC 60245-1
Guide to Use	EN 50565-1/2, VDE 0298-565-1
Electrical Tests	EN 50395, IEC 60245-2
Non-electrical Tests	EN 50396, IEC 60245-2
Conductor Resistance	IEC 60228, VDE 0295
Flame Retardant	IEC 60332-1-2, VDE 0482-332-1-2

OPERATING CHARACTERISTICS

Rated Voltage	300/300 V (U ₀ /U)
AC Test Voltage	2 kV
Operating Temperature	-20°C to +60°C
Conductor Short-Circuit Temp.	200°C (Max. 5 sec)
Min. Handling Temp.	5°C
Min. Bending Radius	EN 50565-1 Tab. 3
Current Carrying Capacities	VDE 0298-4 Tab. 11

APPLICATIONS

These rubber insulated cables with textile braid sheath are mainly used in household appliances and mainly for electrical iron cords. They are also available to use for ovens and roaster where accidental contact with hot surfaces are possible.



HEAT RESISTANT

H03RT-H

Textile Braided Flexible Cable
for Iron Cords

Cross Section (mm ²)	Nominal Overall Diameter (mm)	Approximate Weight (kg / km)	Min.Bending Radius (free movement) (mm)	Max. Resistance of Conductors at 20°C (ohm / km)
3x0,75	7,1	58	28	26
3x1	7,3	71	29	19,5
3x1,5	7,5	89	30	13,3





CABLE STRUCTURE

Conductor	Electrolytic annealed, class 5 stranded tinned copper wires
Separator	A suitable tape may be applied over the conductor
Insulation	EI4 type cross-linked elastomeric compound, EPR (EN 50363-1)
Sheath	EM7 type cross-linked elastomeric compound (EN 50363-2-1)
Color	Black

MAIN CHARACTERISTICS

Construction	Based on EN 50525-2-21, IEC 60502-1, BS 7655-1.2, IEC 60245-4
General Requirements	EN 50363-2-1
Guide to Use	EN 50565-1/2, VDE 0298-565-1
Electrical Tests	EN 50395, IEC 60245-2
Non-electrical Tests	EN 50396, IEC 60245-2
Conductor Resistance	IEC 60228, VDE 0295
Flame Retardant	IEC 60332-1-2, VDE 0482-332-1-2
Oil Resistant	VDE 0473-811-404, EN 60811-404

OPERATING CHARACTERISTICS

Rated Voltage	600/1000 V (U ₀ /U)
AC Test Voltage	4 kV
Operating Temperature	-40°C to +90°C
Conductor Short-Circuit Temp.	250°C (Max. 5 sec.)
Min. Installation Temp.	-25°C
Min. Bending Radius	Based on EN 50565-1 Tab. 3
Current Carrying Capacities	VDE 0298-4 Tab.13 , IEC 60364-5-52 Tab. B.52.12 & Tab. C.52.1

APPLICATIONS

These rubber sheathed single core cables are used as Anode and DC feeder cable in cathodic protection systems for buried structures. Main areas that used are; pipelines, storage tanks, wells, metal structures and vessels. Due to its characteristics it can be used in wet, oily and damp places. They are resistant to chemicals, moisture, water and corrosive gases.



FLAME RETARDANT



OIL RESISTANT



UV RESISTANT



HEAT RESISTANT

Cross Section (mm ²)	Nominal Overall Diameter (mm)	Approximate Weight (kg / km)	Min.Bending Radius (free movement) (mm)	Max. Resistance of Conductors at 20°C (ohm / km)
1x10	11,50	215	1,95	35
1x16	13,00	296	1,24	52
1x25	15,60	429	0,795	62
1x35	16,50	531	0,565	66
1x50	17,80	674	0,393	71
1x70	19,70	880	0,277	79
1x95	22,10	1130	0,21	88



CABLE STRUCTURE

Conductor	Electrolytic annealed, class 5 stranded tinned copper wires
Seperator	A suitable tape may be applied over the conductor, with semi-conductive layer for 3,6/6 kV
Insulation	3GI3 type cross-linked elastomeric compound (VDE 0207 - Part 20)
Sheath	5GM3 type cross-linked elastomeric compound (VDE 0207 - Part 21)
Color	Black

MAIN CHARACTERISTICS

Construction	VDE 0250-602
General Requirements	VDE 0250-1
Guide to Use	VDE 0298-3, VDE 0298-4
Electrical Tests	VDE 0472- 501, 508, 503
Non-electrical Tests	VDE 0472-401, 402, 602, 303, 615, 803, 804
Conductor Resistance	IEC 60228, VDE 0295
Flame Retardant	IEC 60332-1-2, VDE 0482-332-1-2
Oil Resistant	VDE 0473-811-404, EN 60811-404

OPERATING CHARACTERISTICS

Rated Voltage	600/1000 V - 1800/3000 V - 3600/6000 V (U ₀ /U)
AC Test Voltage	4 kV / 6kV / 11 kV
Operating Temperature	
<i>In Flexing Use</i>	-25°C to +90°C
<i>In Fixed Use</i>	-40°C to +90°C
Max. Conductor Operating Temp.	90°C
Conductor Short-Circuit Temp.	250°C (Max. 5 sec)
Min. Installation Temp.	-25°C
Min. Bending Radius	VDE 0298-3 Tab.3
Current Carrying Capacities	VDE 0298-4 Tab. 15

APPLICATIONS

Especially suitable for connections of short circuit and grounding. They are used in railway vehicles, buses, switch cabinets, continuously operating installations, pipes, trays and in closed electrical trays. These cables can be used as connection power cable in transformer substations.



FLAME RETARDANT



OIL RESISTANT



UV RESISTANT

0,6/1kV

Cross Section (mm ²)	Nominal Overall Diameter (mm)	Approximate Weight (kg / km)	Min.Bending Radius (fixed installation) (mm)	Max. Resistance of Conductors at 20°C (ohm / km)
1x1,5	4,80	36	14	13,70
1x2,5	5,40	49	16	8,21
1x4	6,10	69	18	5,09
1x6	6,60	88	20	3,39
1x10	8,10	140	24	1,95
1x16	9,10	197	27	1,24
1x25	11,40	300	34	0,795
1x35	12,70	404	51	0,565
1x50	14,60	551	58	0,393
1x70	16,50	764	66	0,277
1x95	18,45	981	74	0,21
1x120	20,15	1223	81	0,164
1x150	21,95	1504	88	0,132
1x185	24,65	1840	99	0,108
1x240	27,95	2449	112	0,0817
1x300	30,75	3004	123	0,0654

1,8/3 kV

Cross Section (mm ²)	Nominal Overall Diameter (mm)	Approximate Weight (kg / km)	Min.Bending Radius (fixed installation) (mm)	Max. Resistance of Conductors at 20°C (ohm / km)
1x1,5	5,80	48	17	13,70
1x2,5	6,20	60	19	8,21
1x4	6,70	77	20	5,09
1x6	7,20	97	22	3,39
1x10	8,70	151	26	1,95
1x16	9,70	210	29	1,24
1x25	12,60	333	50	0,795
1x35	13,50	428	54	0,565
1x50	15,00	565	60	0,393
1x70	16,90	780	68	0,277
1x95	19,25	1015	77	0,21
1x120	20,95	1261	84	0,164
1x150	22,75	1545	91	0,132
1x185	25,05	1863	100	0,108
1x240	28,38	2475	114	0,0817
1x300	31,15	3033	125	0,0654

3,6/6 kV

Cross Section (mm ²)	Nominal Overall Diameter (mm)	Approximate Weight (kg / km)	Min.Bending Radius (fixed installation) (mm)	Max. Resistance of Conductors at 20°C (ohm / km)
1x1,5	8,70	84	26	13,70
1x2,5	9,10	98	27	8,21
1x4	9,60	117	29	5,09
1x6	11,10	164	33	3,39
1x10	11,60	200	35	1,95
1x16	13,10	278	52	1,24
1x25	15,40	394	62	0,795
1x35	16,40	496	66	0,565
1x50	17,90	639	72	0,393
1x70	22,40	987	90	0,277
1x95	24,60	1233	98	0,21
1x120	23,50	1335	94	0,164
1x150	24,90	1602	100	0,132
1x185	26,80	1901	107	0,108
1x240	30,50	2539	122	0,0817
1x300	33,10	3088	132	0,0654





CABLE STRUCTURE

Conductor	Up to 25mm ² electrolytic annealed class 6 stranded copper wires, 25mm ² and above sections electrolytic annealed class 5 stranded copper wires. (tinned conductor on request)
Seperator	A suitable tape may be applied over the conductor
Insulation	3GI3 type cross-linked elastomeric compound (VDE 0207 - Part 20)
Outer Sheath	5GM3 type cross-linked elastomeric compound (VDE 0207 - Part 21)
Color	Black

MAIN CHARACTERISTICS

Construction	VDE 0250-809
General Requirements	VDE 0250-1
Guide to Use	VDE 0298-3, VDE 0298-4
Electrical Tests	VDE 0472-501, 503, 508
Non-electrical Tests	VDE 0472-401, 402, 602, 303, 615
Conductor Resistance	VDE 0295, IEC 60228
Flame Retardant	IEC 60332-1-2, VDE 0482-332-1-2
Oil Resistant	VDE 0473-811-404, EN 60811-404

OPERATING CHARACTERISTICS

Rated Voltage	300/500 V (U ₀ /U)
AC Test Voltage	2 kV
Operating Temperature	
<i>In Flexing Use</i>	-25°C to +60°C
<i>In Fixed Use</i>	-40°C to +90°C
Conductor Short-Circuit Temp.	250°C (Max. 5 sec)
Min. Installation Temp.	-25°C
Min. Bending Radius	VDE 0298-3 Tab.3
Current Carrying Capacities	VDE 0298-4 Tab.11 & Tab. 15

APPLICATIONS

Especially used for lifts, cranes, floor conveyor systems, elevators and festoon systems. Thanks to its flat structure, recommended for implementations where space is at a minimum and require smaller bending radius over that of round cables.



FLAME RETARDANT



FLAT DESIGN



OIL RESISTANT



UV RESISTANT



WEATHER RESISTANT

Cross Section (mm ²)	Nominal Overall Diameter (mm)	Approximate Weight (kg / km)	Min.Bending Radius (free movement) (mm)	Max. Resistance of Conductors at 20°C (ohm / km)
3x1,5	6,00 x 12,30	126	18	13,30
3x2,5	7,80 x 14,40	181	23	7,98
3x4	8,60 x 18,00	290	34	4,95
3x6	9,40 x 19,20	350	38	3,30
3x10	10,60 x 27,00	619	42	1,91
3x16	12,40 x 27,00	797	62	1,21
3x25	14,00 x 36,70	1224	70	0,78
3x35	15,70 x 39,90	1610	79	0,554
3x50	18,00 x 46,20	2193	90	0,386
3x70	20,50 x 52,50	2998	103	0,272
3x95	23,30 x 60,10	3822	117	0,206
4x1,5	6,00 x 17,30	204	18	13,30
4x2,5	7,80 x 20,00	310	23	7,98
4x4	8,60 x 24,50	427	34	4,95
4x6	9,40 x 27,00	505	38	3,30
4x10	10,60 x 31,60	752	42	1,91
4x16	12,40 x 36,00	1018	62	1,21
4x25	14,00 x 45,00	1522	70	0,78
4x35	15,70 x 50,30	2196	79	0,554
4x50	18,00 x 57,50	2852	90	0,386
4x70	20,50 x 64,80	3872	103	0,272
4x95	23,30 x 74,60	4977	117	0,206
4x120	25,60 x 82,80	6197	128	0,161
5x1,5	6,00 x 21,40	267	18	13,30
5x2,5	7,80 x 24,40	378	23	7,98
5x4	8,60 x 29,50	505	34	4,95
5x6	9,40 x 34,00	652	38	3,30
5x10	10,60 x 40,50	904	42	1,91
5x16	12,40 x 47,00	1301	62	1,21
5x25	14,60 x 57,80	1993	70	0,78
5x35	15,70 x 61,30	2537	79	0,554
7x1,5	6,00 x 26,90	306	18	13,30

Cross Section (mm ²)	Nominal Overall Diameter (mm)	Approximate Weight (kg / km)	Min.Bending Radius (free movement) (mm)	Max. Resistance of Conductors at 20°C (ohm / km)
7x2,5	7,80 x 32,10	493	23	7,98
7x4	8,60 x 38,80	691	34	4,95
7x6	9,40 x 45,80	870	38	3,30
7x10	10,60 x 53,10	1239	42	1,91
7x16	13,00 x 65,00	1950	65	1,21
7x25	15,20 x 77,00	2865	76	0,78
7x35	16,30 x 87,10	3647	82	0,554
8x1,5	6,00 x 31,00	378	18	13,30
8x2,5	7,80 x 37,50	492	23	7,98
10x1,5	6,60 x 39,20	504	20	13,30
10x2,5	8,40 x 47,60	719	34	7,98
12x1,5	6,60 x 47,50	624	20	13,30
12x2,5	8,40 x 54,20	849	34	7,98
16x1,5	6,60 x 62,40	812	20	13,30
16x2,5	8,40 x 71,80	1101	34	7,98
24x1,5	11,90 x 54,70	1366	48	13,30
24x2,5	15,00 x 65,00	2116	60	7,98





CABLE STRUCTURE

Conductor	Up to 25mm ² electrolytic annealed class 6-stranded copper wires, 25mm ² and above sections electrolytic annealed class 5 stranded copper wires. (tinned conductor on request)
Seperator	A suitable tape may be applied over the conductor
Insulation	3GI3 type cross-linked elastomeric compound (VDE 0207 - Part 20)
Screen	Tinned copper wire braiding (coverage min. %80)
Outer Sheath	5GM3 type cross-linked elastomeric compound (VDE 0207 - Part 21)
Color	Black

MAIN CHARACTERISTICS

Construction	VDE 0250-809
General Requirements	VDE 0250-1
Guide to Use	VDE 0298-3, VDE 0298-4
Electrical Tests	VDE 0472-501, 503, 508
Non-electrical Tests	VDE 0472-401, 402, 602, 303, 615
Conductor Resistance	VDE 0295, IEC 60228
Flame Retardant	IEC 60332-1-2, VDE 0482-332-1-2
Oil Resistant	VDE 0473-811-404, EN 60811-404

OPERATING CHARACTERISTICS

Rated Voltage	300/500 V (U ₀ /U)
AC Test Voltage	2 kV
Operating Temperature	
<i>In Flexing Use</i>	-25°C to +60°C
<i>In Fixed Use</i>	-40°C to +90°C
Conductor Short-Circuit Temp.	250°C (Max. 5 sec)
Min. Installation Temp.	-25°C
Min. Bending Radius	VDE 0298-3 Tab.3
Current Carrying Capacities	VDE 0298-4 Tab.11 & Tab. 15

APPLICATIONS

Especially used for lifts, cranes, floor conveyor systems, elevators and festoon systems. Thanks to its flat structure, recommended for implementations where space is at a minimum and require smaller bending radius over that of round cables. Copper screens are efficient against electromagnetic effects caused by other cables.



Cross Section (mm ²)	Nominal Overall Diameter (mm)	Approximate Weight (kg / km)	Min.Bending Radius (free movement) (mm)	Max. Resistance of Conductors at 20°C (ohm / km)
3x1,5	6,80 x 16,60	217	20	13,30
3x2,5	8,10 x 18,00	310	32	7,98
3x4	9,20 x 19,20	424	37	4,95
3x6	10,00 x 24,00	488	40	3,30
3x10	11,70 x 30,00	724	47	1,91
3x16	13,50 x 36,40	1122	68	1,21
3x25	15,00 x 41,10	1550	75	0,78
3x35	16,00 x 43,90	1867	80	0,554
3x50	19,50 x 50,20	2433	98	0,386
3x70	21,50 x 56,50	3261	108	0,272
3x95	24,10 x 64,10	4170	121	0,206
4x1,5	6,80 x 20,40	290	20	13,30
4x2,5	8,10 x 23,10	422	32	7,98
4x4	9,20 x 26,70	498	37	4,95
4x6	10,00 x 32,10	677	40	3,30
4x10	11,70 x 35,60	952	47	1,91
4x16	13,50 x 44,10	1341	68	1,21
4x25	15,00 x 54,00	2004	75	0,78
4x35	16,00 x 56,00	2470	80	0,554
4x50	19,50 x 63,50	3130	98	0,386
4x70	21,50 x 73,80	4588	108	0,272
4x95	24,10 x 79,20	5206	121	0,206
4x120	27,80 x 91,40	7246	139	0,161
5x1,5	6,80 x 27,20	357	20	13,30
5x2,5	8,10 x 31,30	503	32	7,98
5x4	9,20 x 35,80	700	37	4,95
5x6	10,00 x 41,00	3698	40	3,30
5x10	11,70 x 46,30	1211	47	1,91
5x16	13,50 x 52,00	1616	68	1,21
5x25	15,60 x 62,10	2365	75	0,78
5x35	16,00 x 67,10	2881	80	0,554
7x1,5	6,80 x 32,10	501	20	13,30

Cross Section (mm ²)	Nominal Overall Diameter (mm)	Approximate Weight (kg / km)	Min.Bending Radius (free movement) (mm)	Max. Resistance of Conductors at 20°C (ohm / km)
7x2,5	8,10 x 40,10	646	32	7,98
7x4	9,20 x 46,50	902	37	4,95
7x6	10,00 x 52,00	1223	40	3,30
7x10	11,70 x 58,60	1501	47	1,91
7x16	14,10 x 68,30	2184	71	1,21
7x25	15,60 x 89,00	3381	78	0,78
7x35	16,60 x 95,00	4236	83	0,554
8x1,5	6,80 x 38,70	571	20	13,30
8x2,5	8,10 x 47,80	772	32	7,98
10x1,5	7,40 x 48,90	742	22	13,30
10x2,5	8,70 x 58,60	910	35	7,98
12x1,5	7,40 x 53,00	870	22	13,30
12x2,5	8,70 x 68,50	1098	35	7,98
16x1,5	7,40 x 69,00	1027	22	13,30
16x2,5	8,70 x 79,60	1455	35	7,98
24x1,5	12,60 x 67,60	1514	63	13,30
24x2,5	15,00 x 76,00	2075	75	7,98





CABLE STRUCTURE

Conductor	Electrolytic annealed, class 5 stranded plain or tinned copper wires
Seperator	A suitable tape may be applied over the conductor
Insulation	3GI3 type cross-linked elastomeric compound (VDE 0207 - Part 20)
Inner Sheath	GM1b type cross-linked elastomeric compound (VDE 0207 - Part 21)
Reinforcement	Antitorsion textile braided embedded sheath
Outer Sheath	5GM3 type cross-linked elastomeric compound (VDE 0207 - Part 21)
Color	Black

MAIN CHARACTERISTICS

Construction	VDE 0250-814, TSE K 371
General Requirements	VDE 0250-1
Guide to Use	VDE 0298-3, VDE 0298-4
Electrical Tests	VDE 0472-501, 502, 503, 508
Non-electrical Tests	VDE 0472-401, 402, 602, 303, 615
Conductor Resistance	VDE 0295, IEC 60228
Flame Retardant	IEC 60332-1-2, VDE 0482-332-1-2
Oil Resistant	VDE 0473-811-404, EN 60811-404

OPERATING CHARACTERISTICS

Rated Voltage	600 / 1000 V (U_0/U)
AC Test Voltage	3,5 kV
Operating Temperature	
<i>In Flexing Use</i>	-25°C to +80°C
<i>In Fixed Use</i>	-40°C to +80°C
Max. Conductor Operating Temp.	90°C
Conductor Short-Circuit Temp.	250°C (Max. 5 sec)
Min. Installation Temp.	-15°C
Min. Bending Radius	VDE 0298-3 Tab.3
Current Carrying Capacities	VDE 0298-4 Tab.11

APPLICATIONS

As reeling cable for winding operation with tensile stress and/or torsional stress and for connection and control cable in lifting devices, hoisting plants and transporting machines for heavy mechanical load and as drum and drag cable in dry, damp or wet rooms and wet industrial conditions. For monospiral reeling applications, please refer our Reelkab RV (N)SHTÖU cables.

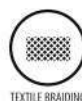

Cross Section (mm ²)	Nominal Overall Diameter (mm)	Approximate Weight (kg / km)	Min.Bending Radius (free movement) (mm)	Max. Resistance of Conductors at 20°C (ohm / km)
3x1,5	11,90	200	48	13,70
3x2,5	13,40	255	67	8,21
3x4	16,10	378	81	5,09
3x6	17,20	455	86	3,39
3x10	21,30	713	107	1,95
3x16	23,40	930	117	1,24
3x25	29,30	1426	147	0,795
3x35	32,70	1868	164	0,565
3x50	38,20	2573	191	0,393
3x70	42,30	3374	212	0,277
3x95	48,40	4410	242	0,206
3x120	52,10	5321	261	0,164
3x150	55,90	6354	280	0,132
3x185	62,70	7836	314	0,108
3x240	71,60	10396	358	0,0817
3x16+10	25,70	1163	129	1,24
3x25+16	31,60	1736	158	0,795
3x35+16	35,10	2219	176	0,554
3x50+25	41,10	3073	206	0,386
3x70+35	45,60	4035	228	0,272
3x95+50	50,40	5077	252	0,206
3x120+70	56,30	6471	282	0,161
3x150+70	60,50	7628	303	0,129
3x185+95	66,00	9155	330	0,106
3x240+120	77,30	12466	387	0,0801
4x1,5	12,70	225	64	13,30
4x2,5	15,60	344	78	7,98
4x4	17,30	448	87	4,95
4x6	18,50	545	93	3,30
4x10	22,00	810	115	1,91
4x16	26,40	1202	132	1,21
4x25	33,30	1860	167	0,78
4x35	35,50	2298	178	0,554

Cross Section (mm ²)	Nominal Overall Diameter (mm)	Approximate Weight (kg / km)	Min.Bending Radius (free movement) (mm)	Max. Resistance of Conductors at 20°C (ohm / km)
4x50	41,50	3171	208	0,386
4x70	46,10	4195	231	0,272
4x95	52,70	5478	264	0,206
4x120	58,60	6883	293	0,161
4x150	62,90	8231	315	0,129
4x185	70,30	10104	352	0,106
4x240	80,10	13381	401	0,0801
5x1,5	13,60	261	68	13,30
5x2,5	16,70	400	84	7,98
5x4	18,60	525	93	4,95
5x6	20,80	683	104	3,30
5x10	24,80	1015	124	1,91
5x16	28,50	1424	143	1,21
5x25	36,10	2212	181	0,78
5x35	40,00	2881	200	0,554
5x50	45,10	3795	226	0,386
5x70	52,10	5270	261	0,272
5x95	58,40	6789	292	0,206
7x1,5	16,70	397	84	13,30
7x2,5	19,00	537	95	7,98
7x4	22,10	760	111	4,95
7x6	23,80	935	119	3,30
7x10	29,80	1493	149	1,91
7x16	34,50	2116	173	1,21
7x25	43,50	3271	218	0,78
7x35	46,50	4069	233	0,554
12x1,5	20,10	570	101	13,30
12x2,5	23,10	782	116	7,98
12x4	27,00	1117	135	4,95
18x1,5	22,80	757	114	13,30
18x2,5	27,20	1116	136	7,98
18x4	32,10	1596	161	4,95

Cross Section (mm ²)	Nominal Overall Diameter (mm)	Approximate Weight (kg / km)	Min.Bending Radius (free movement) (mm)	Max. Resistance of Conductors at 20°C (ohm / km)
24x1,5	25,90	941	130	13,30
24x2,5	31,00	1396	155	7,98
30x2,5	35,7	1921	179	7,98
36x1,5	30,00	1328	150	13,30
36x2,5	36,20	2004	181	7,98



CABLE STRUCTURE

Conductor	Electrolytic annealed, class 5 stranded tinned copper wires with steel supporting elements in the center of conductor
Seperator	A suitable tape may be applied over the conductor
Insulation	3GI3 type cross-linked elastomeric compound (VDE 0207 - Part 20)
Inner Sheath	GM1b type cross-linked elastomeric compound (VDE 0207 - Part 21)
Reinforcement	Antitorsion textile braided embedded sheath
Outer Sheath	5GM3 type cross-linked elastomeric compound (VDE 0207 - Part 21)
Color	Black

MAIN CHARACTERISTICS

Construction	Based on VDE 0250-814, TSE K 371
General Requirements	VDE 0250-1
Guide to Use	VDE 0298-3, VDE 0298-4
Electrical Tests	VDE 0472-501, 502, 503, 508
Non-electrical Tests	VDE 0472-401, 402, 602, 303, 615
Conductor Resistance	VDE 0295, IEC 60228
Flame Retardant	IEC 60332-1-2, VDE 0482-332-1-2
Oil Resistant	VDE 0473-811-404, EN 60811-404

OPERATING CHARACTERISTICS

Rated Voltage	600 / 1000 V (U ₀ /U)
AC Test Voltage	3,5 kV
Operating Temperature	
<i>In Flexing Use</i>	-25°C to +80°C
<i>In Fixed Use</i>	-40°C to +80°C
Max. Conductor Operating Temp.	90°C
Conductor Short-Circuit Temp.	250°C
Min. Installation Temp.	-15°C
Min. Bending Radius	VDE 0298-3, Tab. 3
Current Carrying Capacities	VDE 0298-4 Tab.11

APPLICATIONS

As power cable for polip or peel grap applications and reeling cable for winding operation with tensile stress and/or torsional stress and for connection and control cable in lifting devices, hoisting plants and transporting machines for heavy mechanical load and as drum and drag cable in dry, damp or wet rooms and wet industrial conditions.



Cross Section (mm ²)	Nominal Overall Diameter (mm)	Approximate Weight (kg / km)	Min.Bending Radius (free movement) (mm)	Max. Resistance of Conductors at 20°C (ohm / km)
3x10	23,00	905	115	1,95
3x16	24,50	1160	123	1,24
4x10	25,80	1104	129	1,95
4x16	31,50	1665	158	1,24

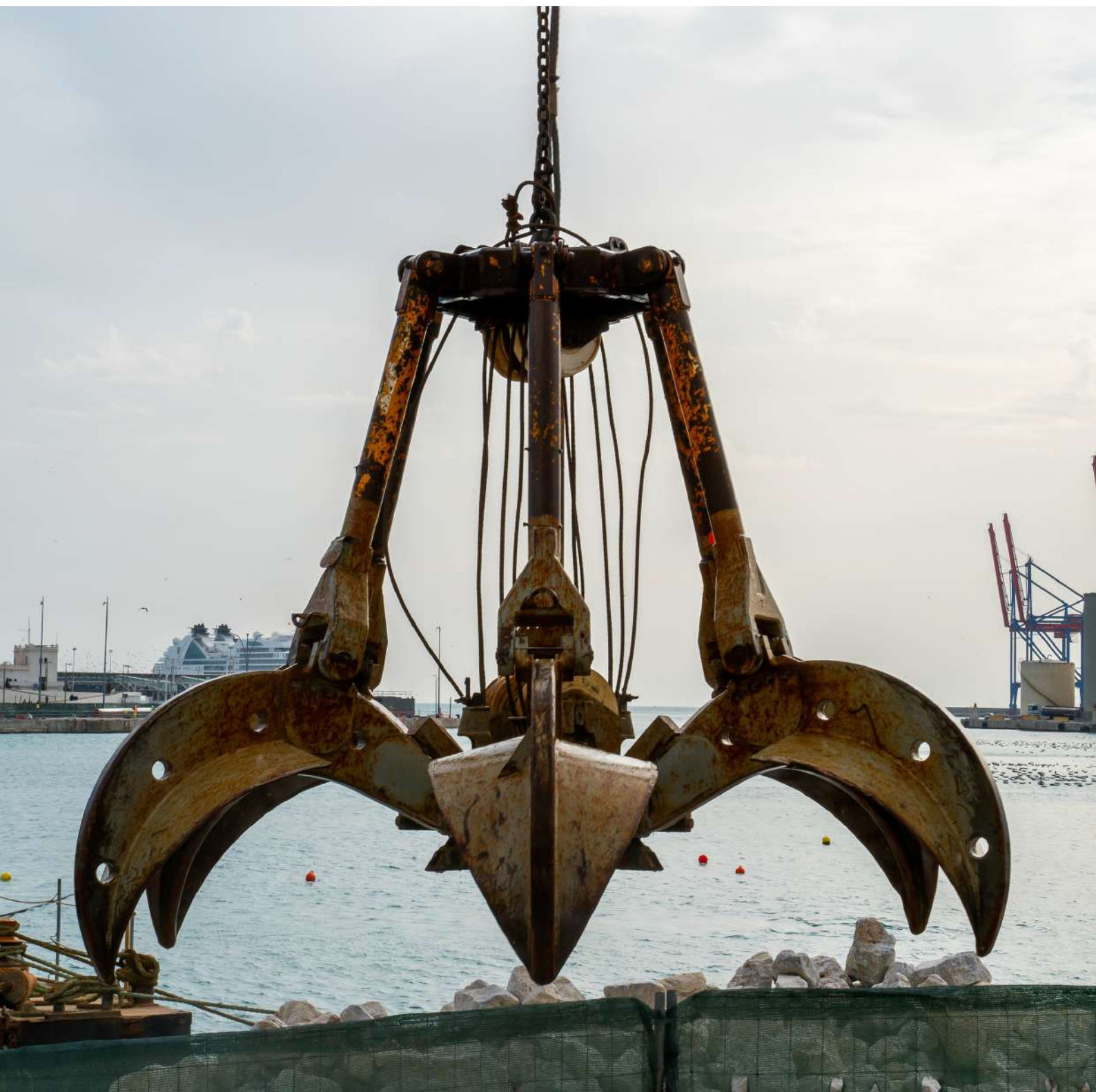



CABLE STRUCTURE

Conductor	Electrolytic annealed, class 5 stranded tinned copper wires
Insulation	3GI3 type cross-linked elastomeric compound (VDE 0207 - Part 20)
Inner Sheath	GM1b type cross-linked elastomeric compound (VDE 0207 - Part 21)
Outer Sheath	5GM5 type cross-linked elastomeric compound (VDE 0207 - Part 21)
Color	Yellow or Black

MAIN CHARACTERISTICS

Construction	VDE 0250-812
General Requirements	VDE 0250-1
Guide to Use	VDE 0298-3, VDE 0298-4
Electrical Tests	VDE 0472-501, 502, 503, 508, 512
Non-electrical Tests	VDE 0472-401, 402, 602, 303, 615, 613
Conductor Resistance	VDE 0295, IEC 60228
Flame Retardant	IEC 60332-1-2, VDE 0482-332-1-2
Oil Resistant	VDE 0473-811-404, EN 60811-404

OPERATING CHARACTERISTICS

Rated Voltage	600 / 1000 V (U ₀ /U)
AC Test Voltage	3 kV
Operating Temperature	
<i>In Flexing Use</i>	-25°C to +80°C
<i>In Fixed Use</i>	-40°C to +80°C
Max. Conductor Operating Temp.	90°C
Conductor Short-Circuit Temp.	250°C (Max. 5 sec)
Min. Installation Temp.	-15°C
Min. Bending Radius	VDE 0298-3 Tab.3
Current Carrying Capacities	VDE 0298-4 Tab. 15

APPLICATIONS

For use in mines, quarries, industrial areas, construction sites, agricultural operations and as trailing cable. The cables are also suitable for fixed application as power supply cable for underground mining and open-cast mining applications, for tunnelling applications and similar applications.



Cross Section (mm ²)	Nominal Overall Diameter (mm)	Approximate Weight (kg / km)	Min.Bending Radius (free movement) (mm)	Max. Resistance of Conductors at 20°C (ohm / km)
1x2,5	7,00	73	21	8,21
1x4	7,70	95	23	5,09
1x6	8,20	116	33	3,39
1x10	9,70	174	39	1,95
1x16	10,70	235	43	1,24
1x25	13,80	371	69	0,795
1x35	14,70	469	74	0,565
1x50	16,60	626	83	0,393
1x70	18,90	865	95	0,277
1x95	20,90	1095	105	0,206
1x120	23,20	1380	116	0,164
1x150	25,00	1673	125	0,132
1x185	28,30	2069	142	0,108
1x240	31,60	2707	158	0,0817
1x300	35,40	3369	177	0,0654
2x1,5	11,40	168	46	13,70
2x2,5	12,70	216	64	8,21
2x4	15,30	320	77	5,09
2x6	16,40	385	82	3,39
2x10	20,20	596	101	1,95
2x16	22,20	768	111	1,24
2x25	27,80	1184	139	0,795
2x35	29,60	1439	148	0,565
2x50	34,80	1998	174	0,393
2x70	40,00	2735	200	0,277
2x95	44,00	3394	220	0,206
3x1,5	11,90	191	48	13,70
3x2,5	13,40	253	67	8,21
3x4	16,10	375	81	5,09
3x6	17,20	454	86	3,39
3x10	21,30	713	107	1,95
3x16	23,40	935	117	1,24

Cross Section (mm ²)	Nominal Overall Diameter (mm)	Approximate Weight (kg / km)	Min.Bending Radius (free movement) (mm)	Max. Resistance of Conductors at 20°C (ohm / km)
3x25	29,40	1441	147	0,795
3x35	32,70	1883	164	0,565
3x50	38,20	2596	191	0,393
3x70	42,30	3411	212	0,277
3x95	48,40	4460	242	0,206
3x120	52,10	5390	261	0,164
3x150	55,90	6444	280	0,132
3x185	62,70	7944	314	0,108
3x25+16	31,60	1698	158	0,795
3x35+16	35,10	2173	176	0,565
3x50+25	42,00	3048	210	0,393
3x70+35	45,60	3967	228	0,277
3x95+50	50,50	4977	253	0,206
3x120+70	56,30	6370	282	0,164
3x150+70	62,20	7790	311	0,132
3x185+95	67,80	9254	339	0,108
3x240+120	77,30	12236	387	0,0801
3x25+16/3	29,80	1601	149	0,795
3x35+25/3	35,90	2327	180	0,565
3x50+25/3	38,40	2794	192	0,393
3x70+35/3	43,70	3783	219	0,277
3x95+50/3	48,30	4767	242	0,206
3x120+70/3	53,90	6062	270	0,164
3x150+70/3	56,30	6903	282	0,132
3x185+95/3	61,20	8291	306	0,108
3x240+120/3	71,10	11185	356	0,0801
4x1,5	12,80	223	64	13,70
4x2,5	15,50	336	78	8,21
4x4	17,20	439	86	5,09
4x6	18,50	540	93	3,39
4x10	23,00	854	115	1,95
4x16	26,40	1208	132	1,24
4x25	33,10	1859	166	0,795
4x35	35,30	2311	177	0,565

Cross Section (mm ²)	Nominal Overall Diameter (mm)	Approximate Weight (kg / km)	Min.Bending Radius (free movement) (mm)	Max. Resistance of Conductors at 20°C (ohm / km)
4x50	41,30	3192	207	0,393
4x70	45,90	4236	230	0,277
4x95	52,50	5537	263	0,206
4x120	58,50	6970	293	0,164
4x150	63,00	8367	315	0,132
4x185	70,40	10266	352	0,108
5x1,5	13,70	261	69	13,7
5x2,5	16,60	394	83	8,21
5x4	18,60	524	93	5,09
5x6	20,80	685	104	3,39
5x10	24,90	1028	125	1,95
5x16	28,60	1444	143	1,24
5x25	36,30	2252	182	0,795
5x35	40,20	2934	201	0,565
5x50	45,30	3873	227	0,393
5x70	52,30	5379	262	0,277
5x95	58,50	6849	293	0,206
7x1,5	16,70	385	84	13,70
7x2,5	18,80	513	94	8,21
7x4	22,00	733	110	5,09
10x1,5	18,90	478	95	13,7
10x2,5	22,20	685	111	8,21
12x1,5	20,10	564	101	13,7
12x2,5	22,80	760	114	8,21
12x4	26,80	1097	134	5,09
18x1,5	23,20	763	116	13,7
18x2,5	27,00	1083	135	8,21
24x1,5	25,90	924	130	13,70
24x2,5	31,90	1429	160	8,21
36x1,5	30,00	1318	150	13,7
36x2,5	36,20	1991	181	8,21
37x1,5	30,00	1328	150	13,70
37x2,5	33,10	1765	166	8,21
48x1,5	34,90	1763	175	13,70



CABLE STRUCTURE

Conductor	Electrolytic annealed, class 5 stranded tinned copper wires
Insulation	3GI3 type cross-linked elastomeric compound (VDE 0207 - Part 20)
Screen	Concentric tinned copper wire braiding
Inner Sheath	GM1b type cross-linked elastomeric compound (VDE 0207 - Part 21)
Outer Sheath	5GM5 type cross-linked elastomeric compound (VDE 0207 - Part 21)
Color	Yellow or Black

MAIN CHARACTERISTICS

Construction	VDE 0250-812
General Requirements	VDE 0250-1
Guide to Use	VDE 0298-3, VDE 0298-4
Electrical Tests	VDE 0472-501, 502, 503, 508, 512
Non-electrical Tests	VDE 0472-401, 402, 602, 303, 615, 613
Conductor Resistance	VDE 0295, IEC 60228
Flame Retardant	IEC 60332-1-2, VDE 0482-332-1-2
Oil Resistant	VDE 0473-811-404, EN 60811-404

OPERATING CHARACTERISTICS

Rated Voltage	600 / 1000 V (U ₀ /U)
AC Test Voltage	3 kV
Operating Temperature	
<i>In Flexing Use</i>	-25°C to +80°C
<i>In Fixed Use</i>	-40°C to +80°C
Max. Conductor Operating Temp.	90°C
Conductor Short-Circuit Temp.	250°C (Max. allowable time 5 sec)
Min. Installation Temp.	-15°C
Min. Bending Radius	VDE 0298-3 Tab.3
Current Carrying Capacities	VDE 0298-4 Tab. 15

APPLICATIONS

The cables are suitable for fixed installation and flexible operation as motor power supply cables for frequency converter controlled drives in the mining and tunneling



ELECTROMAGNETIC
COMPATIBILITY



MECHANICAL
STRESSES RESISTANT



OIL RESISTANT



TEAR RESISTANT



UV RESISTANT



WEATHER RESISTANT

Cross Section (mm ²)	Nominal Overall Diameter (mm)	Approximate Weight (kg / km)	Min.Bending Radius (free movement) (mm)	Max. Resistance of Conductors at 20°C (ohm / km)
2x1,5	12,50	228	63	13,70
2x2,5	14,30	291	72	8,21
2x4	17,30	445	87	5,09
2x6	18,40	519	92	3,39
2x10	22,20	764	111	1,95
2x16	24,40	964	122	1,24
3x35+3x16/3	33,20	2151	166	0,565
3x50+3x25/3	40,20	3171	201	0,393
3x70+3x35/3	45,40	4165	227	0,277
3x95+3x50/3	49,50	5161	248	0,21
3x120+3x70/3	56,50	6840	283	0,164
3x150+3x70/3	58,40	7537	292	0,132
3x185+3x95/3	63,00	8900	315	0,108
3x240+3x120/3	73,80	11846	369	0,0801
4x1,5	14,00	298	70	13,70
4x2,5	17,30	459	87	8,21
4x4	18,80	572	94	5,09
4x6	20,10	680	101	3,39
4x10	24,60	1029	123	1,95
4x16	28,20	1415	141	1,24



CABLE STRUCTURE

Conductor	Electrolytic annealed, class 5 stranded tinned copper wires
Insulation	3GI3 type cross-linked elastomeric compound (VDE 0207 - Part 20)
Electrical Field Control Screens	Inner and outer layer of semiconductive rubber compound, easily strippable
Protective-Earth Cores	Tinned copper conductors with semiconductive layer make up earth cores that split into the interstices
Inner Sheath	GM1b type cross-linked elastomeric compound (VDE 0207 - Part 21)
Reinforcement	Antitorsion textile braided embedded sheath
Outer Sheath	5GM5 type cross-linked elastomeric compound (VDE 0207 - Part 21)
Color	Red

MAIN CHARACTERISTICS

Construction	Based on VDE 0250-813
General Requirements	VDE 0250-1
Guide to Use	VDE 0298-3, VDE 0298-4
Electrical Tests	VDE 0472-501, 512, 508, 502, 503
Non-electrical Tests	VDE 0472-401, 402, 602, 303, 615, 613
Conductor Resistance	VDE 0295, IEC 60228
Flame Retardant	IEC 60332-1-2, VDE 0482-332-1-2
Oil Resistant	VDE 0473-811-404, EN 60811-404

OPERATING CHARACTERISTICS

Rated Voltage	3,6/6 kV 6/10 kV 8,7/15 kV 12/20 kV 18/30 kV 20/35 kV
AC Test voltage	11 kV 17 kV 24 kV 29 kV 43 kV 50 kV
Operating Temperature	
<i>In Flexing Use</i>	-25°C to +80°C
<i>In Fixed Use</i>	-40°C to +90°C
Max. Conductor Operating Temp.	90°C
Conductor Short-Circuit Temp.	250°C (Max. 5 sec.)
Min. Installation Temp.	-15°C
Max. Permissible Tensile Force	15 N / mm ²
Min. Bending Radius	VDE 0298-3 Tab.3
Current Carrying Capacities	VDE 0298-4 Tab. 15
Max. Travel Speed	
<i>For Tunnelling and Mining applications</i>	30 m/min
<i>For Crane or similar application</i>	200 m/min - horizontal

APPLICATIONS

For the connection of electrical equipment, large material handling machines such as excavators, dumpers in mining and tunneling applications. The flexible cable design allows for movement of the equipment during operation.



COLD RESISTANT



EX PROOF



MECHANICAL STRESSES RESISTANT



TEAR RESISTANT



OIL RESISTANT



UV RESISTANT



WEATHER RESISTANT

Cross Section (mm ²)	Nominal Overall Diameter (mm)	Approximate Weight (kg / km)	Min.Bending Radius (free movement) (mm)	Max. Resistance of Conductors at 20°C (ohm / km)
----------------------------------	-------------------------------	------------------------------	---	--

3,6/6 kV

3x25+3x25/3	38,9 - 43,1	2.600	410	0,795
3x35+3x25/3	40,6 - 45,0	2.940	428	0,565
3x50+3x25/3	43,7 - 48,5	3.575	460	0,393
3x70+3x35/3	47,6 - 52,8	4.535	502	0,277
3x95+3x50/3	53,3 - 59,1	5.820	562	0,210
3x120+3x70/3	55,7 - 61,7	6.745	587	0,164
3x150+3x70/3	60,4 - 66,7	7.760	636	0,132
3x185+3x95/3	64,4 - 71,1	9.150	678	0,108

6/10 kV

3x25+3x25/3	39,9 - 44,1	2.710	420	0,795
3x35+3x25/3	41,7 - 46,0	3.050	438	0,565
3x50+3x25/3	44,8 - 49,5	3.690	472	0,393
3x70+3x35/3	48,6 - 53,8	4.660	512	0,277
3x95+3x50/3	54,3 - 60,1	5.960	572	0,210
3x120+3x70/3	56,7 - 62,7	6.890	597	0,164
3x150+3x70/3	61,4 - 67,7	7.875	646	0,132
3x185+3x95/3	65,4 - 72,1	9.300	688	0,108

8,7/15 kV

3x25+3x25/3	42,0 - 46,6	2.850	443	0,795
3x35+3x25/3	44,1 - 48,8	3.330	464	0,565
3x50+3x25/3	47,9 - 53,1	4.040	505	0,393
3x70+3x35/3	52,3 - 57,8	5.045	550	0,277
3x95+3x50/3	55,6 - 61,6	6.150	586	0,210
3x120+3x70/3	59,1 - 65,4	7.350	622	0,164
3x150+3x70/3	63,7 - 70,4	8.130	670	0,132
3x185+3x95/3	67,5 - 74,6	9.540	710	0,108

12/20 kV

3x25+3x25/3	44,6 - 49,3	3.115	470	0,795
3x35+3x25/3	46,9 - 51,9	3.560	494	0,565
3x50+3x25/3	51,6 - 57,2	4.430	544	0,393
3x70+3x35/3	54,8 - 60,6	5.400	577	0,277
3x95+3x50/3	58,0 - 64,2	6.450	611	0,210
3x120+3x70/3	63,2 - 70,0	8.025	666	0,164
3x150+3x70/3	66,0 - 72,8	8.460	694	0,132
3x185+3x95/3	71,5 - 79,0	10.150	753	0,108

Cross Section (mm ²)	Nominal Overall Diameter (mm)	Approximate Weight (kg / km)	Min.Bending Radius (free movement) (mm)	Max. Resistance of Conductors at 20°C (ohm / km)
----------------------------------	-------------------------------	------------------------------	---	--

14/25 kV

3x25+3x25/3	49,4 - 54,6	3.650	520	0,795
3x35+3x25/3	51,4 - 56,8	3.925	541	0,565
3x50+3x25/3	54,6 - 60,3	4.600	575	0,393
3x70+3x35/3	58,6 - 64,7	5.870	617	0,277
3x95+3x50/3	63,4 - 70,1	7.000	668	0,210
3x120+3x70/3	67,0 - 74,0	8.000	705	0,164
3x150+3x70/3	71,4 - 79,0	9.400	752	0,132
3x185+3x95/3	75,3 - 83,2	11.000	793	0,108

18/30 kV

3x25+3x25/3	52,7 - 58,3	4.200	555	0,795
3x35+3x25/3	55,2 - 61,1	4.580	582	0,565
3x50+3x25/3	58,7 - 64,9	5.590	618	0,393
3x70+3x35/3	63,4 - 70,2	6.835	668	0,277
3x95+3x50/3	66,7 - 73,9	7.910	703	0,210
3x120+3x70/3	71,6 - 79,2	9.490	754	0,164
3x150+3x70/3	74,7 - 82,6	10.100	786	0,132

20/35 kV

3x35+3x25/3	58,9 - 65,1	5.230	620	0,565
3x50+3x25/3	64,1 - 70,9	6.480	675	0,393
3x70+3x35/3	67,1 - 74,3	7.445	707	0,277
3x95+3x50/3	70,4 - 78,0	8.555	742	0,210
3x120+3x70/3	75,7 - 83,7	10.170	797	0,164





CABLE STRUCTURE

Conductor	Electrolytic annealed, class 5 stranded plain copper wires (tinned conductor on request)
Insulation	PVC compound, T12 type (EN 50363-3)
Sheath	PVC compound, TM2 type (EN 50363-4-1)
Color	Light Grey

MAIN CHARACTERISTICS

Construction	CEI 20-20/5, CEI 20-11
General Requirements	IMQ-CPT-007, Based on EN 50525-1/2
Guide to Use	CEI 20-40/1, EN 50565-1/2
Electrical Tests	EN 50395
Non - electrical Tests	EN 50396
Conductor Resistance	CEI 20-29, IEC 60228
Flame Retardant	CEI 20-22 II, IEC 60332-1

OPERATING CHARACTERISTICS

Rated Voltage	300/500 or 450/750 V (U ₀ /U)
AC Test Voltage	2 kV / 2,5 kV
Operating Temperature	(Without mechanical shocks)
<i>In Flexing Use</i>	-5°C to +70°C
<i>In Fixed Use</i>	-30°C to +70°C
Conductor Short-Circuit Temp.	160°C (Max. 5 sec)
Min. Installation Temp.	0°C
Min. Bending Radius	Based on EN 50565-1 Tab. 3
Current Carrying Capacities	CEI 20-21, Based on VDE 0298-4 Tab.11

APPLICATIONS

These cables are suitable for fixed laying and connection of movable appliances, and production lines in industries. They can be used in dry, damp and wet places inside and temporary outdoor.



300 / 500 V

Cross Section (mm ²)	Nominal Overall Diameter (mm)	Approximate Weight (kg / km)	Min.Bending Radius (fixed installation) (mm)	Max. Resistance of Conductors at 20°C (ohm / km)
2x1	7,40	80	22	19,50
2x1,5	7,90	95	24	13,30
2x2,5	9,50	140	29	7,98
2x4	10,50	185	32	4,95
2x6	11,80	245	35	3,30
3x1	7,90	95	24	19,50
3x1,5	8,30	111	25	13,30
3x2,5	10,10	170	30	7,98
3x4	11,40	235	34	4,95
3x6	12,80	310	51	3,30
4x1	8,60	115	26	19,50
4x1,5	9,30	141	28	13,30
4x2,5	11,00	210	33	7,98
4x4	12,50	290	50	4,95
4x6	14,00	390	56	3,30
5x1	9,60	142	29	19,50
5x1,5	10,30	175	31	13,30
5x2,5	12,30	260	49	7,98
5x4	14,10	370	56	4,95
5x6	15,60	481	62	3,30

450 / 750 V

Cross Section (mm ²)	Nominal Overall Diameter (mm)	Approximate Weight (kg / km)	Min.Bending Radius (fixed installation) (mm)	Max. Resistance of Conductors at 20°C (ohm / km)
7x1	9,50	152	29	19,50
7x1,5	11,20	205	34	13,30
10x1	12,40	250	50	19,50
10x1,5	14,30	321	57	13,30
12x1	12,80	275	51	19,50
12x1,5	14,90	356	60	13,30
16x1	14,40	355	58	19,50
16x1,5	16,70	452	67	13,30
19x1	15,30	405	61	19,50
19x1,5	17,80	520	71	13,30
24x1	18,00	550	72	19,50
24x1,5	20,90	700	84	13,30
27x1	18,60	595	74	19,50
27x1,5	21,50	751	86	13,30



CABLE STRUCTURE

Conductor	Electrolytic annealed, class 5 stranded plain copper wires (tinned conductor on request)
Insulation	PVC compound, T12 type (EN 50363-3)
Separator	Polyester tape
Screen	Bare copper wire braiding (tinned on request)
Sheath	PVC compound, TM2 type (EN 50363-4-1)
Color	Light Grey

MAIN CHARACTERISTICS

Construction	CEI 20-20/5, CEI 20-11
General Requirements	IMQ-CPT-007, Based on EN 50525-1/2
Guide to Use	CEI 20-40/1, EN 50565-1/2
Electrical Tests	EN 50395
Non - electrical Tests	EN 50396
Conductor Resistance	CEI 20-29, IEC 60228
Flame Retardant	CEI 20-22 II, IEC 60332-1

OPERATING CHARACTERISTICS

Rated Voltage	300/500 or 450/750 V (U ₀ /U)
AC Test Voltage	2 kV / 2,5 kV
Operating Temperature	(Without mechanical shocks)
<i>In Flexing Use</i>	-5°C to +70°C
<i>In Fixed Use</i>	-30°C to +70°C
Conductor Short-Circuit Temp.	160°C (Max. 5 sec)
Min. Installation Temp.	0°C
Min. Bending Radius	Based on EN 50565-1 Tab. 3
Current Carrying Capacities	CEI 20-21, Based on VDE 0298-4 Tab.11

APPLICATIONS

These cables are suitable for fixed laying, connection of movable appliances, and production lines in industries. It's shielded for against electromagnetic disturbances.

They can be used in dry, damp and wet places inside and temporary outdoor.



ELECTROMAGNETIC
COMPATIBILITY



FLAME RETARDANT

300 / 500 V

Cross Section (mm ²)	Nominal Overall Diameter (mm)	Approximate Weight (kg / km)	Min.Bending Radius (fixed installation) (mm)	Max. Resistance of Conductors at 20°C (ohm / km)
2x1	8,10	130	24	19,50
2x1,5	8,60	150	26	13,30
2x2,5	10,20	215	31	7,98
2x4	11,20	275	34	4,95
2x6	12,50	350	50	3,30
3x1	8,60	156	26	19,50
3x1,5	9,00	180	27	13,30
3x2,5	10,80	261	32	7,98
3x4	12,10	345	48	4,95
3x6	13,70	465	55	3,30
4x1	9,30	190	28	19,50
4x1,5	10,00	225	30	13,30
4x2,5	11,70	320	35	7,98
4x4	13,20	430	53	4,95
4x6	14,90	575	60	3,30
5x1	10,30	230	31	19,50
5x1,5	11,00	270	33	13,30
5x2,5	13,00	385	52	7,98
5x4	15,00	536	60	4,95
5x6	16,50	680	66	3,30

450 / 750 V

Cross Section (mm ²)	Nominal Overall Diameter (mm)	Approximate Weight (kg / km)	Min.Bending Radius (fixed installation) (mm)	Max. Resistance of Conductors at 20°C (ohm / km)
7x1	10,20	250	31	19,50
7x1,5	11,90	340	36	13,30
7x2,5	14,40	516	58	7,98
10x1	13,30	400	53	19,50
10x1,5	15,20	530	61	13,30
10x2,5	18,10	770	72	7,98
12x1	13,70	445	55	19,50
12x1,5	15,80	595	63	13,30
12x2,5	18,90	870	76	7,98
16x1	15,30	560	61	19,50
16x1,5	17,60	750	70	13,30
16x2,5	21,00	1095	84	7,98
19x1	16,20	640	65	19,50
19x1,5	18,50	855	74	13,30
19x2,5	22,10	1256	88	7,98
24x1	18,90	840	76	19,50
24x1,5	21,80	1125	87	13,30
24x2,5	26,20	1691	105	7,98





CABLE STRUCTURE

Conductor	Electrolytic annealed, class 5 stranded plain copper wires (tinned conductor on request)
Insulation	Rubber based HEPR or equivalent compound, type G7
Inner Covering	In need, PVC compound for only multi-core cables above 16mm ²
Sheath	Flame retardant PVC compound, Rz type (EN 50363-0, CEI 20-11)
Color	Light Grey

MAIN CHARACTERISTICS

Construction	CEI 20-13, CEI UNEL 35375, CEI UNEL 35377
General Requirements	CEI 20-48
Guide to Use	CEI 20-67
Electrical Tests	EN 50395
Non - electrical Tests	EN 50396
Conductor Resistance	CEI 20-29, IEC 60228
Flame Retardant	CEI 20-22 II, CEI 20-35, IEC 60332-1

OPERATING CHARACTERISTICS

Rated Voltage	600/1000 V (U ₀ /U)
AC Test Voltage	4 kV
Operating Temperature	(Without mechanical shocks)
<i>In Flexing Use</i>	-0°C to +90°C
<i>In Fixed Use</i>	-15°C to +90°C
Conductor Short-Circuit Temp.	250°C (Max. 5 sec)
Min. Installation Temp.	0°C
Min. Bending Radius	CEI UNEL 35375, CEI UNEL 35377
Current Carrying Capacities	CEI 20-21, VDE 0298-4 Tab.13, IEC 60364-5-52 Tab. B.52.12 & Tab. C.52.1

APPLICATIONS

These rubber insulated cables are suitable for both indoor and outdoor use as power and control cable. They are mostly used in industrial facilities, construction sites and residential areas.

They can be used in dry, damp and wet places also allowed for direct and indirect underground laying.



FLAME RETARDANT



WEATHER RESISTANT

Cross Section (mm ²)	Nominal Overall Diameter (mm)	Approximate Weight (kg / km)	Min.Bending Radius (fixed installation) (mm)	Max. Resistance of Conductors at 20°C (ohm / km)
1x1,5	6,00	55	24	13,30
1x2,5	6,20	65	25	7,98
1x4	6,80	85	27	4,95
1x6	7,30	105	29	3,30
1x10	8,60	160	34	1,91
1x16	9,70	220	39	1,21
1x25	11,60	320	46	0,78
1x35	12,80	415	51	0,554
1x50	14,80	575	59	0,386
1x70	17,00	810	68	0,272
1x95	18,50	995	74	0,206
1x120	20,60	1260	82	0,161
1x150	23,10	1590	92	0,129
1x185	25,90	1990	104	0,106
1x240	28,50	2450	114	0,0801
1x300	31,50	3190	126	0,0641
1x400	36,60	4230	146	0,0486
1x500	40,50	5360	162	0,0384
1x630	44,00	6600	176	0,0287
2x1,5	11,50	205	46	13,30
2x2,5	12,40	240	50	7,98
2x4	13,60	310	54	4,95
2x6	14,60	370	58	3,30
2x10	17,30	540	69	1,91
2x16	19,40	720	78	1,21
2x25	23,10	1050	92	0,780
2x35	25,60	1325	102	0,554
2x50	29,80	1850	119	0,39
3x1,5	10,20	140	41	13,30
3x2,5	11,20	180	45	7,98
3x4	12,50	280	50	4,95
3x6	13,80	315	55	3,30

Cross Section (mm ²)	Nominal Overall Diameter (mm)	Approximate Weight (kg / km)	Min.Bending Radius (fixed installation) (mm)	Max. Resistance of Conductors at 20°C (ohm / km)
3x10	16,20	470	65	1,91
3x16	18,70	660	75	1,21
3x25	24,80	1270	99	0,78
3x35	27,10	1650	108	0,554
3x50	32,20	2350	129	0,386
3x70	36,60	3170	146	0,272
3x95	40,10	3890	160	0,206
3x120	45,00	4960	180	0,161
3x150	50,10	6210	200	0,129
3x16+10	20,60	1369	82	1,21
3x25+16	26,20	877	105	0,78
3x35+16	29,00	1742	116	0,554
3x50+25	33,50	2560	134	0,386
3x70+35	38,30	3520	153	0,272
3x95+50	42,70	4470	171	0,206
3x120+70	48,10	5730	192	0,161
3x150+70	50,00	6250	200	0,129
4x1,5	11,00	170	44	13,30
4x2,5	12,10	220	48	7,98
4x4	13,50	290	54	4,95
4x6	14,70	370	59	3,30
4x10	17,90	580	72	1,91
4x16	20,60	830	82	1,21
4x25	26,80	1560	107	0,78
4x35	29,30	1850	117	0,554
4x50	34,70	2614	139	0,386
4x70	40,80	4050	163	0,272
5x1,5	11,90	200	48	13,30
5x2,5	13,10	260	52	7,98
5x4	14,70	355	59	4,95
5x6	16,10	460	64	3,30
5x10	19,60	720	78	1,91

Cross Section (mm ²)	Nominal Overall Diameter (mm)	Approximate Weight (kg / km)	Min.Bending Radius (fixed installation) (mm)	Max. Resistance of Conductors at 20°C (ohm / km)
5x16	22,60	1030	90	1,21
5x25	29,60	1880	118	0,78
5x35	33,60	2550	134	0,554
5x50	39,50	3500	158	0,386
5x70	46,90	5020	188	0,272
7x1,5	12,70	245	51	13,30
7x2,5	14,00	325	56	7,98
10x1,5	15,60	330	62	13,30
10x2,5	17,40	445	70	7,98
12x1,5	16,10	375	64	13,30
12x2,5	18,10	510	72	7,98
16x1,5	17,70	475	71	13,30
16x2,5	19,80	650	79	7,98
19x1,5	18,70	535	75	13,30
19x2,5	20,80	740	83	7,98
24x1,5	21,50	660	86	13,30
24x2,5	24,20	920	97	7,98



CABLE STRUCTURE

Conductor	Electrolytic annealed, class 5 stranded plain copper wires (tinned conductor on request)
Insulation	Rubber based HEPR or equivalent compound, type G7 (EN 50363-0, CEI 20-11)
Inner Covering	Separating foil or PVC compound for multi-core cables above 16mm ² (PVC compound for only multi-core cables)
Screen	Bare copper wire braiding (tinned on request)
Sheath	Flame retardant PVC compound, Rz type (EN 50363-0, CEI 20-11)
Color	Light Grey

MAIN CHARACTERISTICS

Construction	CEI 20-13, CEI UNEL 35375, CEI UNEL 35377
General Requirements	CEI 20-48
Guide to Use	CEI 20-67
Electrical Tests	EN 50395
Non - electrical Tests	EN 50396
Conductor Resistance	CEI 20-29, IEC 60228
Flame Retardant	CEI 20-22 II , CEI 20-35, IEC 60332-1

OPERATING CHARACTERISTICS

Rated Voltage	600/1000 V (U ₀ /U)
AC Test Voltage	4 kV
Working Temperature	(Without mechanical shocks)
<i>In Flexing Use</i>	-0°C to +90°C
<i>In Fixed Use</i>	-15°C to +90°C
Conductor Short-Circuit Temp.	250°C (Max. 5 sec)
Min. Installation Temp.	0°C
Min. Bending Radius	CEI UNEL 35375, CEI UNEL 35377
Current Carrying Capacities	CEI 20-21, VDE 0298-4 Tab.13 , IEC 60364-5-52 Tab. B.52.12 & Tab. C.52.1

APPLICATIONS

These rubber insulated cables are suitable for both indoor and outdoor use as power and control cable. They are mostly used in industrial facilities, construction sites and residential areas. It's shielded for against electromagnetic disturbances. They can be used in dry, damp and wet places also allowed for direct and indirect underground laying.



Cross Section (mm ²)	Nominal Overall Diameter (mm)	Approximate Weight (kg / km)	Min.Bending Radius (fixed installation) (mm)	Max. Resistance of Conductors at 20°C (ohm / km)
1x1,5	6,50	69	52	13,30
1x2,5	7,00	84	56	7,98
1x4	7,80	112	62	4,95
1x6	8,30	135	66	3,30
1x10	9,60	195	77	1,91
1x16	10,90	275	87	1,21
1x25	12,50	375	100	0,78
1x35	13,80	480	110	0,554
1x50	15,50	640	124	0,386
1x70	17,90	892	143	0,272
1x95	19,60	1105	157	0,206
1x120	21,50	1365	172	0,161
1x150	23,90	1705	191	0,129
1x185	27,10	2185	217	0,106
1x240	30,10	2750	241	0,0801
1x300	32,80	3430	262	0,0641
1x400	38,10	4625	305	0,0486
1x500	41,90	5665	335	0,0384
2x1,5	10,20	145	82	13,30
2x2,5	11,10	177	89	7,98
2x4	12,40	220	99	4,95
2x6	13,40	270	107	3,30
2x10	16,10	410	129	1,91
2x16	18,40	550	147	1,21
2x25	24,10	1150	193	0,780
2x35	26,70	1485	214	0,554
2x50	30,60	1970	245	0,39
3x1,5	10,70	175	86	13,30
3x2,5	11,70	215	94	7,98
3x4	12,90	270	103	4,95
3x6	14,10	345	113	3,30
3x10	17,10	530	137	1,91

Cross Section (mm ²)	Nominal Overall Diameter (mm)	Approximate Weight (kg / km)	Min.Bending Radius (fixed installation) (mm)	Max. Resistance of Conductors at 20°C (ohm / km)
3x16	19,50	730	156	1,21
3x25	25,60	1420	205	0,78
3x35	28,50	1810	228	0,554
3x50	32,90	2480	263	0,386
3x70	39,10	3510	313	0,272
3x95	42,40	4280	339	0,206
3x120	47,40	5380	379	0,161
3x150	52,30	6650	418	0,129
3x16+10	23,40	1062	187	1,21
3x25+16	28,10	1576	225	0,78
3x35+16	30,20	1933	242	0,554
3x50+25	34,60	2760	277	0,386
3x70+35	39,60	3810	317	0,272
3x95+50	44,20	4820	354	0,206
3x120+70	49,20	6105	394	0,161
3x150+70	54,90	7215	439	0,129
4x1,5	11,60	205	93	13,30
4x2,5	12,60	260	101	7,98
4x4	14,10	340	113	4,95
4x6	15,20	420	122	3,30
4x10	18,70	665	150	1,91
4x16	21,30	930	170	1,21
4x25	28,20	1750	226	0,78
4x35	31,40	2380	251	0,554
4x50	36,60	3175	293	0,386
4x70	43,20	4485	346	0,272
5x1,5	12,40	242	99	13,30
5x2,5	13,70	320	110	7,98
5x4	15,40	430	123	4,95
5x6	16,80	532	134	3,30
5x10	20,30	820	162	1,91
5x16	23,40	1145	187	1,21

Cross Section (mm ²)	Nominal Overall Diameter (mm)	Approximate Weight (kg / km)	Min.Bending Radius (fixed installation) (mm)	Max. Resistance of Conductors at 20°C (ohm / km)
5x25	30,60	2085	245	0,78
5x35	34,80	2765	278	0,554
5x50	40,10	3780	321	0,386
5x70	47,70	5410	382	0,272
7x1,5	13,20	290	106	13,30
7x2,5	16,30	385	130	7,98
10x1,5	16,90	400	135	13,30
10x2,5	18,20	520	146	7,98
12x1,5	16,90	440	135	13,30
12x2,5	18,80	590	150	7,98
16x1,5	18,50	552	148	13,30
16x2,5	20,60	745	165	7,98
19x1,5	19,40	620	155	13,30
19x2,5	21,60	852	173	7,98
24x1,5	22,30	760	178	13,30
24x2,5	25,20	1075	202	7,98



CABLE STRUCTURE

Conductor	Electrolytic annealed, class 5 stranded plain copper wires (tinned conductor on request)
Insulation	Rubber based HEPR or equivalent compound, type G7 (EN 50363-0, CEI 20-11)
Inner Covering	Separating foil or PVC compound (PVC compound for 25 mm ² and above multi-core cables)
Screen 1	Al-Pes Tape (%100 covered)
Screen 2	Bare copper wire braiding (tinned wire on request)
Outer Sheath	Flame retardant PVC compound, Rz type (EN 50363-0, CEI 20-11)
Color	Light Grey or any other color

MAIN CHARACTERISTICS

Construction	CEI 20-13, CEI UNEL 35375, CEI UNEL 35377
General Requirements	CEI 20-48
Guide to Use	CEI 20-67
Electrical Tests	EN 50395
Non - electrical Tests	EN 50396
Conductor Resistance	CEI 20-29, IEC 60228
Flame Retardant	CEI 20-22 II, CEI 20-35, IEC 60332-1-2

OPERATING CHARACTERISTICS

Rated Voltage	0,6/1 kV (U ₀ / U)
AC Test Voltage	4 kV
Operating Temperature	
<i>In Flexing Use</i>	0°C to +90°C
<i>In Fixed Use</i>	-15°C to +90°C
Conductor Short-Circuit Temp.	250°C (Max. 5 sec.)
Min. Installation Temp.	0°C
Min. Bending Radius	CEI UNEL 35375, CEI UNEL 35377
Current Carrying Capacities	CEI 20-21, VDE 0298-4 Tab.13, IEC 60364-5-52 Tab. B.52.12 & Tab. C.52.1

APPLICATIONS

These cables are used as motor power supply cables with frequency converters where there is electromagnetic interference exist. Generally used in industries like automotive, air conditioning, packing, chemical and food. They can be used in dry, wet, oily and damp places inside under medium mechanical stress.



Cross (*) Section (mm ²)	Nominal Overall Diameter (mm)	Approximate Weight (kg / km)	Min.Bending Radius (fixed installation) (mm)	Max. Resistance of Conductors at 20°C (ohm / km)
3x1,5/1,5	10,60	146	85	13,30
3x2,5/2,5	11,60	191	93	7,98
3x4/4	12,80	265	102	4,95
3x6/6	14,70	356	118	3,30
3x10/10	17,30	545	138	1,91
3x16/16	19,50	780	156	1,21
3x25/16	25,80	1385	206	0,78
3x35/16	27,70	1671	222	0,554
3x50/25	32,00	2350	256	0,386
3x70/35	37,60	3355	301	0,272
3x95/50	41,40	4310	331	0,206
3x120/70	46,60	5530	373	0,161
3x150/95	51,10	6946	409	0,129
3x185/95	56,80	8275	454	0,106
3x240/120	63,90	10755	511	0,0801

(*) Copper braid shield screen cross section is equal to phase conductor for phase cross sections $\leq 16\text{mm}^2$ or equal to almost half of the phase conductor for phase cross sections $\geq 25\text{mm}^2$



CABLE STRUCTURE

Conductor	Electrolytic annealed, class 5 stranded plain copper wires (tinned conductor on request)
Insulation	Rubber based HEPR or equivalent compound, type G7 (EN 50363-0, CEI 20-11)
Inner Covering	Halogen-Free thermoplastic compound (for only multi-core cables above 16 mm ²)
Sheath	Halogen-Free thermoplastic compound, M1 type (EN 50363-0, CEI 20-11)
Color	Green (Black on request)

MAIN CHARACTERISTICS

Construction	CEI 20-13, CEI UNEL 35382, CEI UNEL 35384
General Requirements	CEI 20-48
Guide to Use	CEI 20-67
Electrical Tests	EN 50395
Non - electrical Tests	EN 50396
Conductor Resistance	CEI 20-29, IEC 60228
Flame Retardant	CEI 20-22 III, IEC 60332-1-2, IEC 60332-3-24
Halogen Content	CEI 20-37, IEC 60754-1/2
Smoke Density	CEI 20-37, IEC 61034-1/2

OPERATING CHARACTERISTICS

Rated Voltage	600/1000 V (U ₀ /U)
AC Test Voltage	4 kV
Working Temperature	(Without mechanical shocks)
<i>In Flexing Use</i>	-0°C to +90°C
<i>In Fixed Use</i>	-15°C to +90°C
Conductor Short-Circuit Temp.	250°C (Max. 5 sec)
Min. Installation Temp.	0°C
Min. Bending Radius	UNEL 35382, UNEL 35384
Current Carrying Capacities	CEI 20-21, VDE 0298-4 Tab.13 , IEC 60364-5-52 Tab. B.52.12 & Tab. C.52.1

Notes : Not Covered by CPR.

APPLICATIONS

These rubber insulated cables are suitable for both indoor and outdoor use as power and control cable. They are mostly used in environments at risk of fire like offices, subways, hospitals, etc. also equipments and systems that have to be protected from corrosive gasses. They can be used in dry, damp and wet places also allowed for direct and indirect underground laying.



Cross Section (mm ²)	Nominal Overall Diameter (mm)	Approximate Weight (kg / km)	Min.Bending Radius (fixed installation) (mm)	Max. Resistance of Conductors at 20°C (ohm / km)
1x1,5	5,80	48	23	13,30
1x2,5	6,20	60	25	7,98
1x4	6,70	76	27	4,95
1x6	7,20	96	29	3,30
1x10	8,30	141	33	1,91
1x16	9,30	195	37	1,21
1x25	11,40	295	46	0,78
1x35	12,30	385	49	0,554
1x50	14,00	522	56	0,386
1x70	16,30	743	65	0,272
1x95	17,90	942	72	0,206
1x120	20,00	1196	80	0,161
1x150	22,00	1480	88	0,129
1x185	24,30	1785	97	0,106
1x240	27,60	2381	110	0,0801
1x300	30,40	2926	122	0,0641
1x400	35,70	3850	143	0,0486
1x500	38,80	5055	155	0,0384
2x1,5	9,50	125	38	13,30
2x2,5	10,40	160	42	7,98
2x4	11,40	203	46	4,95
2x6	12,50	260	50	3,30
2x10	14,70	380	59	1,91
2x16	16,70	530	67	1,21
2x25	22,80	920	91	0,78
2x35	24,60	1157	98	0,554
2x50	28,20	1560	113	0,386
2x70	33,00	2201	132	0,272
3x1,5	10,00	142	40	13,30
3x2,5	11,00	185	44	7,98
3x4	12,00	245	48	4,95
3x6	13,20	315	53	3,30

Cross Section (mm ²)	Nominal Overall Diameter (mm)	Approximate Weight (kg / km)	Min.Bending Radius (fixed installation) (mm)	Max. Resistance of Conductors at 20°C (ohm / km)
3x10	15,60	475	62	1,91
3x16	17,80	675	71	1,21
3x25	24,20	1142	97	0,780
3x35	26,10	1461	104	0,554
3x50	30,00	1983	120	0,386
3x70	35,30	2831	141	0,272
3x95	39,00	3575	156	0,206
3x120	43,90	4565	176	0,161
3x150	47,90	5570	192	0,129
3x185	53,70	6840	215	0,106
3x240	60,80	9035	243	0,0801
3x300	66,80	11046	267	0,0641
3x16+10	21,30	897	85	1,21
3x25+16	26,20	1350	105	0,780
3x35+16	28,50	1805	114	0,554
3x50+25	33,30	2366	133	0,386
3x70+35	38,60	3320	154	0,272
3x95+50	43,10	4260	172	0,206
3x120+70	48,10	5437	192	0,161
3x150+70	52,70	6561	211	0,129
3x185+95	59,00	8096	236	0,106
3x240+120	66,80	10650	267	0,0801
3x300+150	74,00	13145	296	0,0641
4x1,5	10,80	166	43	13,30
4x2,5	11,90	220	48	7,98
4x4	13,10	295	52	4,95
4x6	14,40	385	58	3,30
4x10	17,10	585	68	1,91
4x16	19,50	845	78	1,21
4x25	26,50	1415	106	0,780
4x35	28,80	1836	115	0,554
4x50	33,60	2540	134	0,386

Cross Section (mm ²)	Nominal Overall Diameter (mm)	Approximate Weight (kg / km)	Min.Bending Radius (fixed installation) (mm)	Max. Resistance of Conductors at 20°C (ohm / km)
4x70	39,00	3575	156	0,272
5x1,5	11,60	197	46	13,30
5x2,5	12,90	265	52	7,98
5x4	14,20	355	57	4,95
5x6	15,70	470	63	3,30
5x10	18,70	716	75	1,91
5x16	21,40	1031	86	1,21
5x25	29,20	1735	117	0,780
5x35	32,30	2301	129	0,554
5x50	37,30	3145	149	0,386
5x70	43,80	4485	175	0,272
7x1,5	12,50	235	50	13,30
7x2,5	13,80	317	55	7,98
10x1,5	15,40	320	62	13,30
10x2,5	17,10	435	68	7,98
12x1,5	15,80	360	63	13,30
12x2,5	17,70	495	71	7,98
16x1,5	17,40	450	70	13,30
16x2,5	19,50	625	78	7,98
19x1,5	18,30	503	73	13,30
19x2,5	20,50	706	82	7,98
24x1,5	21,20	626	85	13,30
24x2,5	23,80	882	95	7,98



CABLE STRUCTURE

Conductor	Electrolytic, stranded, annealed copper wires, Class 2 (tinned conductor on request)
Conductor Screen	Extruded inner semiconductive layer
Insulation	Rubber based HEPR compound, type G7 (IEC 60502-2, HD 620 S2 P.1)
Conductor Screen	Extruded outer semiconductive layer (strippable)
Screen	Overall concentric lay of copper wires and copper tape
Inner Covering	PVC compound (only for multicores)
Sheath	Flame retardant PVC compound, Rz type (IEC 60502-2, HD 620 S2 P.1)
Color	Red

MAIN CHARACTERISTICS

Construction	CEI 20-13, IEC 60502-2
General Requirements	CEI 20-22 II
Guide to Use	CEI 11-17, HD 620 S2
Electrical Tests	CEI 20-16, IEC 60885-3, HD 605
Non - electrical Tests	IEC 60811 series
Conductor Resistance	CEI 20-29, IEC 60228
Flame Retardant	CEI 20-22 II ,CEI 20-35, IEC 60332-1

OPERATING CHARACTERISTICS

Rated Voltage	3,6/6 kV - 6/10 kV - 8,7/15 kV - 12/20 kV (U ₀ /U)
AC Test Voltage	11 kV / 17 kV / 24 kV / 29 kV
Operating Temperature	-15°C to +90°C
Conductor Short-Circuit Temp.	250°C (Max. 5 sec)
Min. Installation Temp.	0°C
Min. Bending Radius (during installation)	
<i>Single Core Cables</i>	15x Outer Diameter
<i>Multi Core Cables</i>	12x Outer Diameter
Current Carrying Capacities	In compliance with CEI 20-21, VDE 0298-4 Tab. 15, IEC 60287 and HD 620 S2

APPLICATIONS

These medium voltage cables are used in energy supply between power distribution systems to end users. They are used in industries like airports, wind-farms and others as power cable. They can be used free-hanging, in tubes and channels or laid underground. These cables can be used as connection power cables in transformer substations.



3,6/6 kV

Cross Section (mm ²)	Nominal Overall Diameter (mm)	Approximate Weight (kg / km)	Min.Bending Radius (fixed installation) (mm)	Max. Resistance of Conductors at 20°C (ohm / km)
1x25/16	21,00	745	315	0,727
1x35/16	22,30	853	335	0,524
1x50/16	26,30	1010	395	0,387
1x70/16	25,10	1220	377	0,268
1x95/16	26,10	1501	392	0,193
1x120/16	27,80	1756	417	0,153
1x150/25	30,50	2167	458	0,124
1x185/25	32,50	2572	488	0,0991
1x240/25	35,00	3131	525	0,074
1x300/25	37,80	3810	567	0,0601
1x400/35	41,50	4840	623	0,0470
1x500/35	45,40	5911	681	0,0366
3x25/16	43,90	2865	527	0,727
3x35/16	46,90	3341	563	0,524
3x50/16	50,00	3985	600	0,387
3x70/16	53,80	4885	646	0,268
3x95/16	58,10	5980	697	0,193
3x120/16	61,50	6970	738	0,153
3x150/25	66,50	8350	798	0,124
3x185/25	71,40	9920	857	0,0991
3x240/25	76,70	12056	920	0,074
3x300/25	82,80	14595	994	0,0601
3x400/35	90,90	18175	1091	0,0470

6/10 kV

1x25/16	21,80	775	327	0,727
1x35/16	23,10	886	347	0,524
1x50/16	24,40	1045	366	0,387
1x70/16	25,90	1255	389	0,268
1x95/16	27,90	1541	419	0,193
1x120/16	29,40	1800	441	0,153
1x150/25	31,30	2212	470	0,124
1x185/25	33,50	2625	503	0,0991
1x240/25	36,00	3210	540	0,074
1x300/25	38,60	3865	579	0,0601
1x400/35	42,50	4932	638	0,047
1x500/35	45,80	5956	687	0,0366
3x25/16	45,90	3070	551	0,727
3x35/16	48,90	3560	587	0,524
3x50/16	51,90	4200	623	0,387
3x70/16	55,70	5115	668	0,268
3x95/16	59,80	6201	718	0,193
3x120/16	63,40	7235	761	0,153
3x150/25	68,20	8601	818	0,124
3x185/25	73,30	10225	880	0,0991
3x240/25	78,70	12406	944	0,074
3x300/25	84,50	14910	1014	0,0601
3x400/35	93,00	18621	1116	0,0470

8,7/15 kV

Cross Section (mm ²)	Nominal Overall Diameter (mm)	Approximate Weight (kg / km)	Min.Bending Radius (fixed installation) (mm)	Max. Resistance of Conductors at 20°C (ohm / km)
1x25/16	24,2	880	363	0,727
1x35/16	25,5	995	383	0,524
1x50/16	27	1175	405	0,387
1x70/16	28,3	1377	425	0,268
1x95/16	30,3	1671	455	0,193
1x120/16	31,8	1935	477	0,153
1x150/25	33,7	2360	506	0,124
1x185/25	35,9	2793	539	0,0991
1x240/25	38,2	3350	573	0,074
1x300/25	41	4045	615	0,0601
1x400/35	45,6	5143	684	0,0470
1x500/35	48,9	6182	734	0,0366
3x25/16	50,8	3596	610	0,727
3x35/16	54,4	4205	653	0,524
3x50/16	57,4	4885	689	0,387
3x70/16	60,9	5795	731	0,268
3x95/16	65	6930	780	0,193
3x120/16	68,4	7970	821	0,153
3x150/25	73,7	9485	884	0,124
3x185/25	78,3	11066	940	0,0991
3x240/25	83,6	13285	1003	0,074
3x300/25	89,6	15891	1075	0,0601

12/20 kV

1x25/16	26,20	971	393	0,727
1x35/16	27,70	1110	416	0,524
1x50/16	29,00	1275	435	0,387
1x70/16	30,50	1500	458	0,268
1x95/16	32,30	1785	485	0,193
1x120/16	34,00	2071	510	0,153
1x150/25	35,90	2502	539	0,124
1x185/25	37,90	2930	569	0,0991
1x240/25	40,40	3512	606	0,074
1x300/25	43,20	4220	648	0,0601
1x400/35	47,60	5311	714	0,047
1x500/35	50,90	6362	764	0,0366
3x35/16	58,90	7080	707	0,527
3x50/16	62,00	7950	744	0,387
3x70/16	65,40	9045	785	0,268
3x95/16	69,70	10451	836	0,193
3x120/16	73,50	11775	882	0,153
3x150/25	78,30	15420	940	0,124
3x185/25	83,00	17425	996	0,074
3x240/25	88,30	20115	1060	0,0601
3x300/25	94,80	23386	1138	0,047





CABLE STRUCTURE

Conductor	Electrolytic annealed, class 5 stranded plain copper wires (tinned conductor on request)
Insulation	PVC compound, T12 type (EN 50363-3)
Sheath	PVC compound, TM2 type (EN 50363-4-1)
Color	Black or White (Grey on request)

MAIN CHARACTERISTICS

Construction	EN 50525-2-11
General Requirements	EN 50525-1, IEC 60227-5, EN 50575
Guide to Use	EN 50565-1/2
Electrical Tests	EN 50395
Non - electrical Tests	EN 50396
Conductor Resistance	IEC 60228, VDE 0295, BS 6360
Flame Retardant	IEC 60332-1-2

OPERATING CHARACTERISTICS

Rated Voltage	300/500 V (U ₀ /U)
AC Test Voltage	2 kV
Working Temperature	
<i>In Flexing Use</i>	-5°C to +70°C
<i>In Fixed Use</i>	-30°C to +70°C
Conductor Short-Circuit Temp.	150°C (Max. 5 sec)
Min. Installation Temp.	5°C
Min. Bending Radius	EN 50565-1 Tab. 3
Current Carrying Capacities	VDE 0298-4 Tab.11

APPLICATIONS

They are mainly used in mobile equipments, household and portable appliances where there is low mechanical stress.



FLAME RETARDANT

Cross Section (mm ²)	Nominal Overall Diameter (mm)	Approximate Weight (kg / km)	Min.Bending Radius (free movement) (mm)	Max. Resistance of Conductors at 20°C (ohm / km)
2x0,75	6,20	54	31	26,00
2x1	6,60	64	33	19,50
2x1,5	7,40	82	37	13,30
2x2,5	8,80	122	44	7,98
2x4	10,00	168	50	4,95
2x6	11,20	223	56	3,30
2x10	15,20	397	91	1,91
3x0,50	6,40	59	32	39,00
3x0,75	6,60	66	33	26,00
3x1	7,00	77	35	19,50
3x1,5	8,30	109	42	13,30
3x2,5	9,60	155	48	7,98
3x4	10,80	213	54	4,95
3x6	12,10	285	73	3,30
3x10	17,20	558	103	1,91
3x16	19,10	760	115	1,21
3x25	23,30	334	140	0,780
3x35	27,20	403	163	0,554
3x16+10	20,40	887	122	1,21
3x25+16	25,40	1383	152	0,780
3x35+16	29,60	1827	178	0,554
3x50+25	34,80	2565	209	0,386
3x50+35	35,00	2625	210	0,386
3x70+35	38,40	3356	230	0,272
4x0,75	7,20	80	36	26,00
4x1	7,85	98	39	19,50
4x1,5	9,00	131	45	13,30
4x2,5	10,45	191	52	7,98
4x4	11,86	267	59	4,95
4x6	13,67	371	82	3,30
4x10	18,80	690	113	1,91
4x16	20,90	951	125	1,21

Cross Section (mm ²)	Nominal Overall Diameter (mm)	Approximate Weight (kg / km)	Min.Bending Radius (free movement) (mm)	Max. Resistance of Conductors at 20°C (ohm / km)
4x25	25,60	1446	154	0,780
4x35	30,00	1950	180	0,554
5x0,75	8,10	98	41	26,00
5x1	8,60	116	43	19,50
5x1,5	10,10	161	51	13,30
5x2,5	11,70	233	59	7,98
5x4	13,50	333	81	4,95
5x6	15,00	444	90	3,30
5x10	20,60	288	124	1,91
5x16	22,90	334	137	1,21
5x25	28,20	465	169	0,780
5x35	33,10	565	199	0,554
6x1	9,50	143	48	19,50
6x1,5	11,00	193	55	13,30
6x2,5	12,60	276	76	7,98
7x1	9,50	149	48	19,50
7x1,5	11,00	201	55	13,30
7x2,5	12,80	298	77	7,98
7x4	14,50	419	87	4,95
7x6	16,30	570	98	3,30
8x1	11,10	197	56	19,50
8x1,5	12,70	263	76	13,30
9x1	12,20	231	73	19,50
10x0,75	11,40	183	57	26,00
10x1	12,40	225	74	19,50
10x1,5	14,30	302	86	13,30
12x1	12,80	256	77	19,50
12x1,5	14,70	344	88	13,30
14x1	13,50	292	81	19,50
14x1,5	15,40	390	92	13,30
16x1	14,20	331	85	19,50

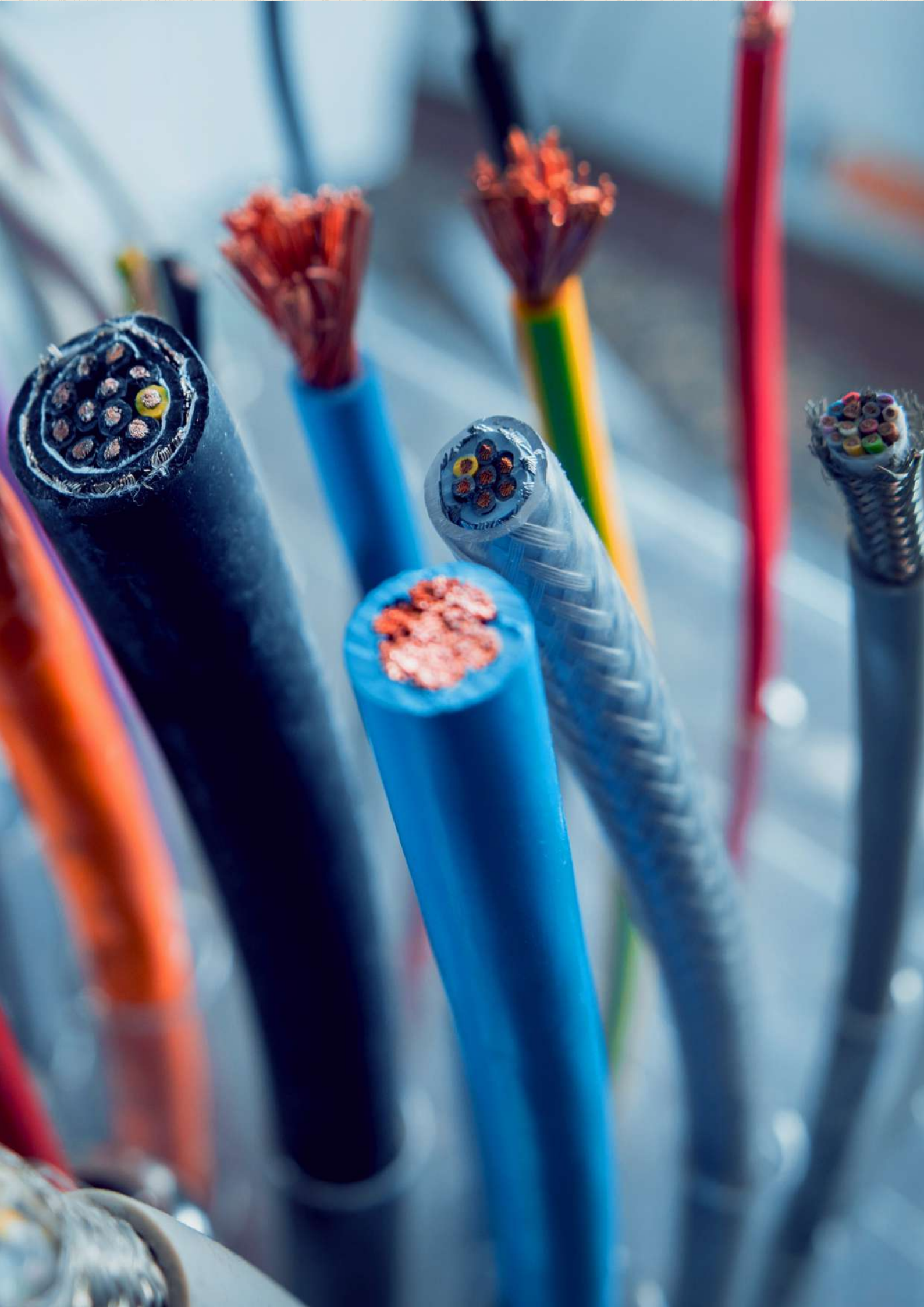



CABLE STRUCTURE

Conductor	Electrolytic annealed, class 5 stranded plain copper wires (tinned conductor on request)
Insulation	PVC compound, T12 type (EN 50363)
Sheath	PVC compound, TM5 type (Oil Resistant and Flame Retardant, EN 50363-4-1)
Color	Grey

MAIN CHARACTERISTICS

Construction	EN 50525-2-51
General Requirements	EN 50525-1/2, EN 50575
Guide to Use	EN 50565-1/2
Electrical Tests	EN 50395
Non - electrical Tests	EN 50396
Conductor Resistance	IEC 60228, VDE 0295, BS 6360
Flame Retardant	IEC 60332-1-2
Oil Resistant	IEC 60811-404, VDE 0473-811-404

OPERATING CHARACTERISTICS

Rated Voltage	300/500 V (U ₀ /U)
AC Test Voltage	2 kV
Working Temperature	
<i>In Flexing Use</i>	-5°C to +70°C
<i>In Fixed Use</i>	-30°C to +70°C
Conductor Short-Circuit Temp.	150°C (Max. 5 sec)
Min. Installation Temp.	5°C
Min. Bending Radius	EN 50565-1 Tab. 3
Current Carrying Capacities	VDE 0298-4 Tab.11

APPLICATIONS

These flexible cables are used as control cables for machines, production lines, control systems, assembly lines, measuring systems and data processing where there is low mechanical stress exist. They can be used in dry, wet, oily and damp places inside and temporary outdoor. Also resistant for various chemicals.



FLAME RETARDANT



OIL RESISTANT

Cross Section (mm ²)	Nominal Overall Diameter (mm)	Approximate Weight (kg / km)	Min.Bending Radius (free movement) (mm)	Max. Resistance of Conductors at 20°C (ohm / km)
2x0,50	5,60	43	28	39,00
2x0,75	6,20	55	31	26,00
2x1	6,60	64	33	19,50
2x1,5	7,40	84	37	13,30
2x2,5	9,10	130	46	7,98
3x0,50	6,00	51	30	39,00
3x0,75	6,60	66	33	26,00
3x1	7,00	77	35	19,50
3x1,5	8,10	105	41	13,30
3x2,5	9,90	162	50	7,98
4x0,50	6,70	65	34	39,00
4x0,75	7,20	81	36	26,00
4x1	7,70	95	39	19,50
4x1,5	8,80	130	44	13,30
4x2,5	10,80	200	54	7,98
5x0,50	7,30	79	37	39,00
5x0,75	7,90	97	40	26,00
5x1	8,40	115	42	19,50
5x1,5	9,70	157	49	13,30
5x2,5	11,90	243	60	7,98
6x0,50	8,10	96	41	39,00
6x0,75	8,70	119	44	26,00
6x1	9,50	145	48	19,50
6x1,5	10,90	197	55	13,30
6x2,5	13,10	295	79	7,98
7x0,50	8,90	115	45	39,00
7x0,75	9,70	147	49	26,00
7x1	10,40	173	52	19,50
7x1,5	12,10	241	73	13,30
7x2,5	14,50	359	87	7,98
12x0,50	11,00	168	55	39,00
12x0,75	11,80	210	59	26,00

Cross Section (mm ²)	Nominal Overall Diameter (mm)	Approximate Weight (kg / km)	Min.Bending Radius (free movement) (mm)	Max. Resistance of Conductors at 20°C (ohm / km)
12x1	12,80	255	77	19,50
12x1,5	14,70	346	88	13,30
12x2,5	17,80	529	107	7,98
18x0,50	12,90	239	77	39,00
18x0,75	14,10	306	85	26,00
18x1	15,10	363	91	19,50
18x1,5	17,50	503	105	13,30
18x2,5	21,40	777	128	7,98
27x0,50	15,70	342	94	39,00
27x0,75	17,20	439	103	26,00
27x1	18,40	522	110	19,50
27x1,5	21,50	731	129	13,30
27x2,5	26,00	1123	156	7,98
36x0,50	17,70	449	106	39,00
36x0,75	19,30	577	116	26,00
36x1	20,90	697	125	19,50
36x1,5	24,30	972	146	13,30
36x2,5	29,50	1489	177	7,98
48x0,50	20,50	589	123	39,00
48x0,75	22,40	756	134	26,00
48x1	24,20	913	145	19,50
48x1,5	28,10	1269	169	13,30
48x2,5	33,70	1927	202	7,98
60x0,50	22,50	728	135	39,00
60x0,75	24,70	946	148	26,00
60x1	26,70	1142	160	19,50
60x1,5	30,90	1582	185	13,30
60x2,5	36,80	2366	221	7,98





CABLE STRUCTURE

Conductor	Electrolytic annealed, class 5 stranded plain copper wires (tinned conductor on request)
Insulation	PVC compound, T12 type (EN 50363)
Inner Sheath	PVC compound, TM2 type (50363-4-1)
Screen	Tinned copper wire braiding
Sheath	PVC compound, TM5 type (Oil Resistant and Flame Retardant, EN 50363-4-1)
Color	Grey

MAIN CHARACTERISTICS

Construction	EN 50525-2-51
General Requirements	EN 50525-1/2, EN 50575
Guide to Use	EN 50565-1/2
Electrical Tests	EN 50395
Non - electrical Tests	EN 50396
Conductor Resistance	IEC 60228, VDE 0295, BS 6360
Flame Retardant	IEC 60332-1-2
Oil Resistant	IEC 60811-404, VDE 0473-811-404

OPERATING CHARACTERISTICS

Rated Voltage	300/500 V (U ₀ /U)
AC Test Voltage	2 kV
Working Temperature	
<i>In Flexing Use</i>	-5°C to +70°C
<i>In Fixed Use</i>	-30°C to +70°C
Conductor Short-Circuit Temp.	150°C (Max. 5 sec)
Min. Installation Temp.	5°C
Min. Bending Radius	EN 50565-1 Tab. 3
Current Carrying Capacities	VDE 0298-4 Tab.11

APPLICATIONS

These flexible cables are used as signal and control cables for machines, production lines, control systems, assembly lines, measuring systems and data processing where there is low mechanical stress exist. They can be used in dry, wet, oily and damp places inside and also outdoor temporarily. Also resistant for various chemicals. It's shielded for against electromagnetic disturbances.



Cross Section (mm ²)	Nominal Overall Diameter (mm)	Approximate Weight (kg / km)	Min.Bending Radius (free movement) (mm)	Max. Resistance of Conductors at 20°C (ohm / km)
2x0,50	8,00	92	40	39,00
2x0,75	8,40	104	42	26,00
2x1	8,80	116	44	19,50
2x1,5	10,00	154	50	13,30
2x2,5	11,40	200	57	7,98
3x0,50	8,40	104	42	39,00
3x0,75	8,80	118	44	26,00
3x1	9,40	136	47	19,50
3x1,5	10,30	167	52	13,30
3x2,5	12,00	233	72	7,98
4x0,50	8,90	117	45	39,00
4x0,75	9,60	140	48	26,00
4x1	10,10	157	51	19,50
4x1,5	11,30	201	57	13,30
4x2,5	13,60	297	82	7,98
5x0,50	9,80	140	49	39,00
5x0,75	10,30	163	52	26,00
5x1	11,00	190	55	19,50
5x1,5	12,50	248	75	13,30
5x2,5	14,80	360	89	7,98
6x0,50	10,30	156	52	39,00
6x0,75	11,10	188	56	26,00
6x1	11,70	214	59	19,50
6x1,5	13,80	301	83	13,30
6x2,5	16,00	421	96	7,98
7x0,50	11,30	187	57	39,00
7x0,75	12,20	225	73	26,00
7x1	13,00	261	78	19,50
7x1,5	15,10	363	91	13,30
7x2,5	16,80	474	101	7,98
12x0,50	13,80	275	83	39,00
12x0,75	14,60	323	88	26,00

Cross Section (mm ²)	Nominal Overall Diameter (mm)	Approximate Weight (kg / km)	Min.Bending Radius (free movement) (mm)	Max. Resistance of Conductors at 20°C (ohm / km)
12x1	15,60	378	94	19,50
12x1,5	17,50	484	105	13,30
12x2,5	21,00	728	126	7,98
18x0,50	15,50	356	93	39,00
18x0,75	16,90	441	101	26,00
18x1	17,90	507	107	19,50
18x1,5	20,30	671	122	13,30
18x2,5	24,60	910	148	7,98
27x0,50	18,60	492	112	39,00
27x0,75	20,20	611	121	26,00
27x1	21,40	710	128	19,50
27x1,5	25,30	1000	152	13,30
27x2,5	29,80	1440	179	7,98
36x0,50	20,70	621	124	39,00
36x0,75	22,30	751	134	26,00
36x1	23,90	900	143	19,50
36x1,5	28,40	1286	170	13,30
36x2,5	33,20	1865	199	7,98
48x0,50	23,60	792	142	39,00
48x0,75	26,00	1026	156	26,00
48x1	28,20	1233	169	19,50
48x1,5	32,50	1676	195	13,30
48x2,5	37,80	2406	227	7,98
60x0,50	26,10	981	157	39,00
60x0,75	28,30	1220	170	26,00
60x1	30,10	1421	181	19,50
60x1,5	35,00	1946	210	13,30
60x2,5	40,80	2812	245	7,98





CABLE STRUCTURE

Conductor	Electrolytic annealed, class 5 stranded plain copper wires (tinned conductor on request)
Insulation	PVC compound, T12 type (EN 50363-3)
Core Identification	JZ: Black cores with a green yellow core OZ: Black cores without a green yellow core
Sheath	PVC compound, TM2 type (EN 50363-4-1)
Color	Grey

MAIN CHARACTERISTICS

Construction	Based on EN 50525-2-11 and BA 14112019
General Requirements	EN 50525-1/2, VDE 0245-201, EN 50575
Guide to Use	EN 50565-1/2, TSE K 373
Electrical Tests	EN 50395
Non - electrical Tests	EN 50396
Conductor Resistance	IEC 60228, VDE 0295, BS 6360
Flame Retardant	IEC 60332-1-2

OPERATING CHARACTERISTICS

Rated Voltage	300/500 V (U ₀ /U)
AC Test Voltage	2 kV
Working Temperature	
<i>In Flexing Use</i>	-5°C to +70°C
<i>In Fixed Use</i>	-30°C to +70°C
Conductor Short-Circuit Temp.	150°C (Max. 5 sec)
Min. Installation Temp.	-5 °C
Min. Bending Radius	Based on EN 50565-1 Tab. 3
Current Carrying Capacities	Based on VDE 0298-4 Tab.11

APPLICATIONS

These flexible cables are used as control cables for machines, production lines, control systems, assembly lines, measuring systems and data processing where there is low mechanical stress exist. They can be used in dry, wet and damp places inside and also outdoor if protected from UV.



FLAME RETARDANT

Cross Section (mm ²)	Nominal Overall Diameter (mm)	Approximate Weight (kg / km)	Min.Bending Radius (free movement) (mm)	Max. Resistance of Conductors at 20°C (ohm / km)
2x0,50	5,00	37	25	39,00
2x0,75	5,40	44	27	26,00
2x1	5,80	52	29	19,50
2x1,5	6,20	63	31	13,30
2x2,5	6,81	85	34	7,98
2x4	8,39	133	42	4,95
2x6	10,00	193	50	3,30
2x10	13,20	330	79	1,91
3x0,50	5,29	45	26	39,00
3x0,75	5,70	52	29	26,00
3x1	6,15	64	31	19,50
3x1,5	6,55	78	33	13,30
3x2,5	7,39	111	37	7,98
3x4	8,92	170	45	4,95
3x6	10,62	246	53	3,30
3x10	15,25	466	92	1,91
3x16	16,73	637	100	1,21
3x16+10	18,40	769	110	1,21
3x25+16	23,76	1213	143	0,780
3x35+16	26,20	1539	157	0,554
3x50+25	31,90	2240	191	0,386
3x50+35	32,60	2354	196	0,386
3x70+35	35,00	2969	210	0,272
3x95+50	44,80	4510	269	0,206
4x0,50	5,75	54	29	39,00
4x0,75	6,20	64	31	26,00
4x1	6,70	79	34	19,50
4x1,5	7,40	101	37	13,30
4x2,5	8,10	140	41	7,98
4x4	10,01	219	50	4,95
4x6	11,71	312	59	3,30
4x10	17,10	599	103	1,91

Cross Section (mm ²)	Nominal Overall Diameter (mm)	Approximate Weight (kg / km)	Min.Bending Radius (free movement) (mm)	Max. Resistance of Conductors at 20°C (ohm / km)
4x16	18,82	818	113	1,21
4x25	24,94	1312	150	0,780
5x0,50	6,30	63	32	39,00
5x0,75	6,80	77	34	26,00
5x1	7,51	97	38	19,50
5x1,5	8,10	119	41	13,30
5x2,5	8,90	168	45	7,98
5x4	11,00	263	55	4,95
5x6	13,10	383	79	3,30
6x0,5	6,70	73	34	39,00
6x0,75	7,50	93	38	26,00
6x1	8,10	114	41	19,50
6x1,5	8,80	142	44	13,30
6x2,5	9,80	204	49	7,98
7x0,5	6,70	77	34	39,00
7x0,75	7,50	98	38	26,00
7x1	8,10	120	41	19,50
7x1,5	8,80	151	44	13,30
7x2,5	9,80	219	49	7,98
8x0,50	7,70	98	39	39,00
8x0,75	8,60	125	43	26,00
8x1	9,30	153	47	19,50
8x1,5	10,60	205	53	13,30
8x2,5	11,50	280	58	7,98
10x0,50	8,60	112	43	39,00
10x0,75	9,40	138	47	26,00
10x1	10,40	175	52	19,50
10x1,5	11,30	218	57	13,30
10x2,5	12,60	317	76	7,98
12x0,50	8,90	127	45	39,00
12x0,75	10,00	162	50	26,00
12x1	10,80	200	54	19,50

Cross Section (mm ²)	Nominal Overall Diameter (mm)	Approximate Weight (kg / km)	Min.Bending Radius (free movement) (mm)	Max. Resistance of Conductors at 20°C (ohm / km)
12x1,5	11,60	250	58	13,30
12x2,5	13,10	368	79	7,98
14x0,50	9,36	143	47	39,00
14x0,75	10,40	182	52	26,00
14x1	11,30	226	57	19,50
14x1,5	12,80	302	77	13,30
14x2,5	13,70	419	82	7,98
16x0,50	10,00	166	50	39,00
16x0,75	11,00	207	55	26,00
16x1	11,90	256	60	19,50
16x1,5	13,50	342	81	13,30
16x2,5	14,70	483	88	7,98
18x0,50	10,50	184	53	39,00
18x0,75	11,50	230	58	26,00
18x1	12,70	291	76	19,50
18x1,5	14,20	381	85	13,30
18x2,5	15,40	538	92	7,98
19x0,50	10,50	187	53	39,00
19x0,75	11,50	234	58	26,00
19x1	12,70	298	76	19,50
19x1,5	14,20	391	85	13,30
19x2,5	15,40	554	92	7,98
24x0,50	12,40	240	74	39,00
24x0,75	13,60	299	82	26,00
24x1	15,00	379	90	19,50
24x1,5	16,80	499	101	13,30
24x2,5	18,20	706	109	7,98
25x0,50	12,70	256	76	39,00
25x0,75	14,00	320	84	26,00
25x1	15,40	404	92	19,50
25x1,5	17,40	540	104	13,30
25x2,5	18,70	751	112	7,98

Cross Section (mm ²)	Nominal Overall Diameter (mm)	Approximate Weight (kg / km)	Min.Bending Radius (free movement) (mm)	Max. Resistance of Conductors at 20°C (ohm / km)
30x0,50	13,10	286	79	39,00
30x0,75	14,40	358	86	26,00
30x1	15,90	455	95	19,50
30x1,5	18,00	609	108	13,30
30x2,5	19,50	865	117	7,98
32x0,50	13,60	307	82	39,00
32x0,75	15,20	393	91	26,00
32x1	16,50	490	99	19,50
32x1,5	18,70	655	112	13,30
32x2,5	20,20	929	121	7,98
36x0,50	14,10	338	85	39,00
36x0,75	15,70	431	94	26,00
36x1	17,30	547	104	19,50
36x1,5	19,60	731	118	13,30
36x2,5	21,00	1028	126	7,98
40x0,50	14,90	391	89	39,00
40x0,75	16,40	490	98	26,00
40x1	18,00	621	108	19,50
40x1,5	20,40	830	122	13,30
40x2,5	22,10	1176	133	7,98





CABLE STRUCTURE

Conductor	Electrolytic annealed, class 5 stranded plain copper wires (tinned conductor on request)
Insulation	PVC compound, TI2 type (EN 50363-3)
Core Identification	JZ: Black cores with a green yellow core OZ: Black cores without a green yellow core
Separator	Separating foil (Polyster tape)
Screen	Tinned copper wire braiding
Sheath	PVC compound, TM2 type (EN 50363-4-1)
Color	Grey

MAIN CHARACTERISTICS

Construction	Based on EN 50525-2-11 and BA 14112019
General Requirements	EN 50525-1/2, VDE 0245-201, EN 50575
Guide to Use	EN 50565-1/2, TSE K 373
Electrical Tests	EN 50395
Non - electrical Tests	EN 50396
Conductor Resistance	IEC 60228, VDE 0295, BS 6360
Flame Retardant	IEC 60332-1-2

OPERATING CHARACTERISTICS

Rated Voltage	300/500 V (U ₀ /U)
AC Test Voltage	2 kV
Working Temperature	
<i>In Flexing Use</i>	-5°C to +70°C
<i>In Fixed Use</i>	-30°C to +70°C
Conductor Short-Circuit Temp.	150°C (Max. 5 sec)
Min. Installation Temp.	-5 °C
Min. Bending Radius	Based on EN 50565-1 Tab. 3
Current Carrying Capacities	Based on VDE 0298-4 Tab.11

APPLICATIONS

These flexible cables are used as signal and control cables for machines, production lines, control systems, assembly lines, measuring systems and data processing where there is low mechanical stress exist. They can be used in dry, wet and damp places inside and also outdoor if protected from UV. It's shielded for against electromagnetic disturbances.



Cross Section (mm ²)	Nominal Overall Diameter (mm)	Approximate Weight (kg / km)	Min.Bending Radius (free movement) (mm)	Max. Resistance of Conductors at 20°C (ohm / km)
2x0,50	5,50	39	28	39,00
2x0,75	5,90	46	30	26,00
2x1	6,30	53	32	19,50
2x1,5	6,70	62	34	13,30
2x2,5	7,38	84	37	7,98
2x4	8,98	127	45	4,95
2x6	10,38	173	52	3,30
2x10	13,58	310	81	1,91
3x0,50	5,80	48	29	39,00
3x0,75	6,30	56	32	26,00
3x1	6,70	67	34	19,50
3x1,5	7,18	82	36	13,30
3x2,5	8,08	114	40	7,98
3x4	9,58	169	48	4,95
3x6	11,28	240	56	3,30
3x10	14,48	394	87	1,91
4x0,50	6,30	57	32	39,00
4x0,75	6,70	68	34	26,00
4x1	7,28	83	36	19,50
4x1,5	7,78	101	39	13,30
4x2,5	8,68	142	43	7,98
4x4	10,38	212	52	4,95
4x6	12,28	304	74	3,30
4x10	15,88	499	95	1,91
5x0,50	6,80	69	34	39,00
5x0,75	7,38	85	37	26,00
5x1	8,18	107	41	19,50
5x1,5	8,68	128	43	13,30
5x2,5	9,48	175	47	7,98
5x4	11,58	269	58	4,95
5x6	13,68	384	82	3,30
5x10	17,68	635	106	1,91

Cross Section (mm ²)	Nominal Overall Diameter (mm)	Approximate Weight (kg / km)	Min.Bending Radius (free movement) (mm)	Max. Resistance of Conductors at 20°C (ohm / km)
6x0,5	7,38	82	37	39,00
6x0,75	8,08	103	40	26,00
6x1	8,68	123	43	19,50
6x1,5	9,38	150	47	13,30
6x2,5	10,18	207	51	7,98
7x0,5	7,38	86	37	39,00
7x0,75	8,08	108	40	26,00
7x1	8,68	130	43	19,50
7x1,5	9,38	160	47	13,30
7x2,5	10,18	222	51	7,98
8x0,50	8,58	113	43	39,00
8x0,75	9,28	136	46	26,00
8x1	9,98	163	50	19,50
8x1,5	10,98	206	55	13,30
8x2,5	11,98	282	60	7,98
10x0,50	9,18	121	46	39,00
10x0,75	9,98	147	50	26,00
10x1	10,98	183	55	19,50
10x1,5	11,88	227	59	13,30
10x2,5	12,98	317	78	7,98
12x0,50	9,48	137	47	39,00
12x0,75	10,38	168	52	26,00
12x1	11,38	210	57	19,50
12x1,5	12,18	259	73	13,30
12x2,5	13,68	374	82	7,98
14x0,50	9,88	153	49	39,00
14x0,75	10,98	193	55	26,00
14x1	11,88	237	59	19,50
14x1,5	12,78	295	77	13,30
14x2,5	14,28	426	86	7,98
16x0,50	10,38	173	52	39,00
16x0,75	11,58	218	58	26,00

Cross Section (mm ²)	Nominal Overall Diameter (mm)	Approximate Weight (kg / km)	Min.Bending Radius (free movement) (mm)	Max. Resistance of Conductors at 20°C (ohm / km)
16x1	12,48	267	75	19,50
16x1,5	13,68	340	82	13,30
16x2,5	15,08	484	90	7,98
18x0,50	11,08	197	55	39,00
18x0,75	12,08	242	72	26,00
18x1	13,08	297	78	19,50
18x1,5	14,38	378	86	13,30
18x2,5	15,78	539	95	7,98
19x0,50	11,08	200	55	39,00
19x0,75	12,08	246	72	26,00
19x1	13,08	304	78	19,50
19x1,5	14,38	388	86	13,30
19x2,5	15,78	556	95	7,98
24x0,50	12,78	247	77	39,00
24x0,75	14,18	312	85	26,00
24x1	15,38	385	92	19,50
24x1,5	16,88	490	101	13,30
24x2,5	18,90	723	113	7,98
25x0,50	13,08	263	78	39,00
25x0,75	14,58	333	87	26,00
25x1	15,78	409	95	19,50
25x1,5	17,18	520	103	13,30
25x2,5	19,40	766	116	7,98
30x0,50	13,68	300	82	39,00
30x0,75	14,98	372	90	26,00
30x1	16,48	469	99	19,50
30x1,5	17,78	590	107	13,30
30x2,5	20,00	874	120	7,98
32x0,50	14,18	319	85	39,00
32x0,75	15,58	397	93	26,00
32x1	17,08	500	102	19,50
32x1,5	18,60	637	112	13,30

Cross Section (mm ²)	Nominal Overall Diameter (mm)	Approximate Weight (kg / km)	Min.Bending Radius (free movement) (mm)	Max. Resistance of Conductors at 20°C (ohm / km)
32x2,5	20,80	932	125	7,98
36x0,50	14,68	352	88	39,00
36x0,75	16,28	446	98	26,00
36x1	17,68	554	106	19,50
36x1,5	19,50	717	117	13,30
36x2,5	21,70	1048	130	7,98
40x0,50	15,28	390	92	39,00
40x0,75	16,98	495	102	26,00
40x1	18,50	623	111	19,50
40x1,5	20,20	795	121	13,30
40x2,5	22,60	1165	136	7,98

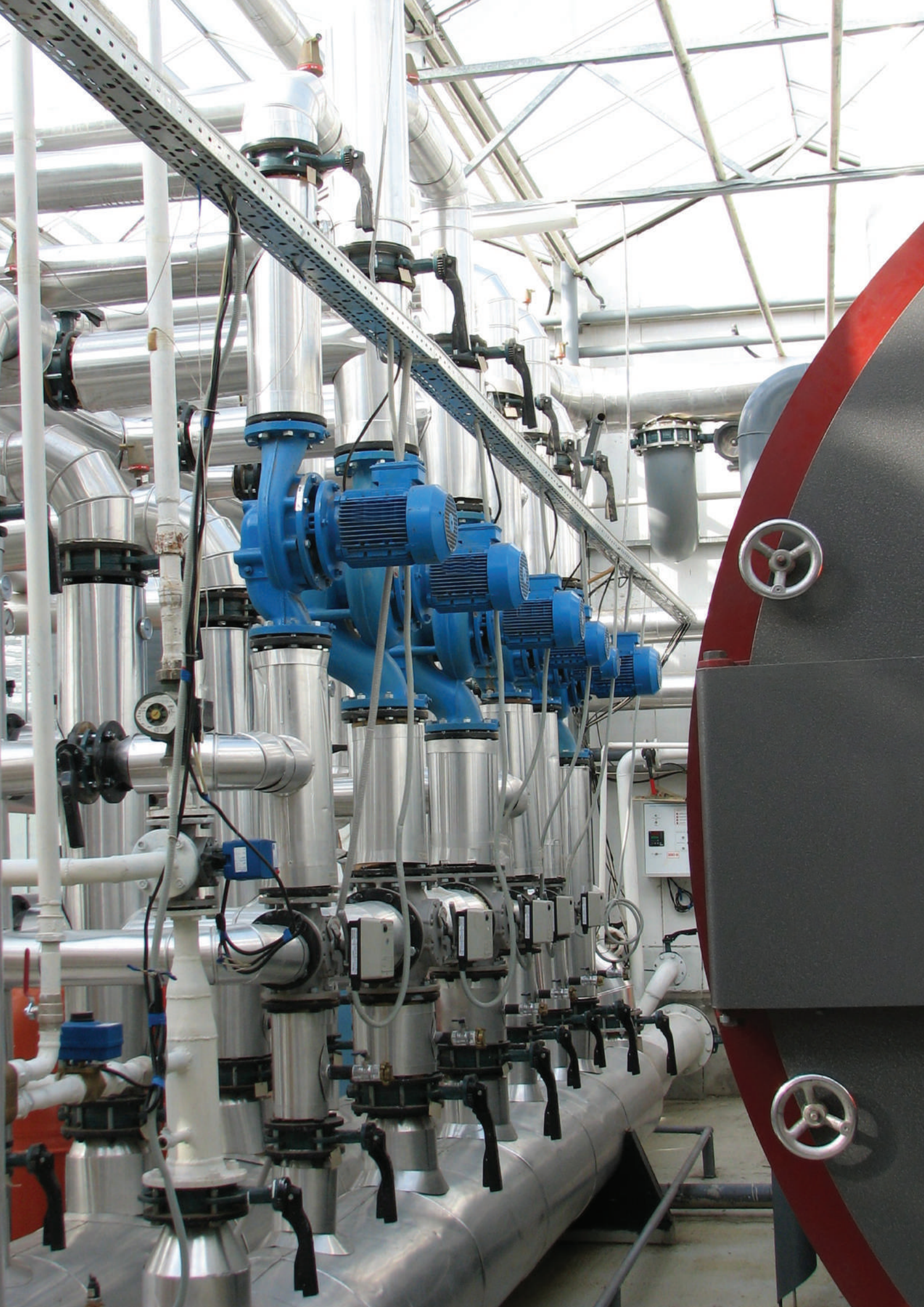



CABLE STRUCTURE

Conductor	Electrolytic annealed, class 5 stranded plain copper wires (tinned conductor on request)
Insulation	PVC compound, T12 type (EN 50363-3)
Core Identification	JZ: Black cores with a green yellow core OZ: Black cores without a green yellow core
Inner Sheath	Extruded Special PVC compound
Screen	Tinned copper wire braiding
Sheath	PVC compound, TM2 type (EN 50363-4-1)
Color	Grey or Transparent

MAIN CHARACTERISTICS

Construction	Based on EN 50525-2-11
General Requirements	EN 50525-1/2, VDE 0245-201, EN 50575
Guide to Use	EN 50565-1/2, TSE K 373
Electrical Tests	EN 50395
Non - electrical Tests	EN 50396
Conductor Resistance	IEC 60228, VDE 0295, BS 6360
Flame Retardant	IEC 60332-1-2

OPERATING CHARACTERISTICS

Rated Voltage	300/500 V (U ₀ /U)
AC Test Voltage	2 kV
Working Temperature	
<i>In Flexing Use</i>	-5°C to +70°C
<i>In Fixed Use</i>	-30°C to +70°C
Conductor Short-Circuit Temp.	150°C (Max. 5 sec)
Min. Installation Temp.	-5 °C
Min. Bending Radius	Based on EN 50565-1 Tab. 3
Current Carrying Capacities	Based on VDE 0298-4 Tab.11

APPLICATIONS

These flexible cables are used as signal and control cables for machines, production lines, control systems, assembly lines, measuring systems and data processing where there is low mechanical stress exist. They can be used in dry, wet and damp places inside and also outdoor if protected from UV. It's shielded for against electromagnetic disturbances.



Cross Section (mm ²)	Nominal Overall Diameter (mm)	Approximate Weight (kg / km)	Min.Bending Radius (free movement) (mm)	Max. Resistance of Conductors at 20°C (ohm / km)
2x0,50	7,00	68	35	39,00
2x0,75	7,40	80	37	26,00
2x1	8,00	90	40	19,50
2x1,5	8,50	115	43	13,30
2x2,5	9,90	130	50	7,98
2x4	11,10	110	56	4,95
3x0,50	7,20	70	36	39,00
3x0,75	8,00	95	40	26,00
3x1	8,20	105	41	19,50
3x1,5	8,90	130	45	13,30
3x2,5	10,50	180	53	7,98
3x4	12,20	250	73	4,95
3x6	14,10	340	85	3,30
3x10	17,50	605	105	1,91
4x0,50	8,00	90	40	39,00
4x0,75	8,40	110	42	26,00
4x1	8,70	125	44	19,50
4x1,5	9,70	155	49	13,30
4x2,5	10,40	220	52	7,98
4x4	13,20	315	79	4,95
4x6	15,80	455	95	3,30
4x10	18,70	705	112	1,91
4x16	21,80	1000	131	1,21
4x25	26,00	1480	156	0,780
4x35	26,00	1480	156	0,554
4x50	34,50	2700	207	0,386
4x70	40,50	3880	243	0,272
4x95	46,30	5070	278	0,206
4x120	51,60	6280	310	0,161
5x0,50	8,30	100	42	39,00
5x0,75	9,00	125	45	26,00
5x1	9,50	145	48	19,50
5x1,5	10,50	185	53	13,30

Cross Section (mm ²)	Nominal Overall Diameter (mm)	Approximate Weight (kg / km)	Min.Bending Radius (free movement) (mm)	Max. Resistance of Conductors at 20°C (ohm / km)
5x2,5	12,80	280	77	7,98
5x4	14,50	385	87	4,95
5x6	17,10	555	103	3,30
5x10	20,70	875	124	1,91
5x16	23,80	1230	143	1,21
5x25	29,00	1930	174	0,780
5x35	33,00	2400	198	0,554
7x0,50	8,80	125	44	39,00
7x0,75	9,70	145	49	26,00
7x1	10,30	175	52	19,50
7x1,5	11,40	225	57	13,30
7x2,5	13,70	345	82	7,98
10x0,50	11,00	160	55	39,00
10x0,75	11,70	210	59	26,00
10x1	12,80	250	77	19,50
10x1,5	14,20	330	85	13,30
10x2,5	16,60	520	100	7,98
12x0,50	11,20	180	56	39,00
12x0,75	12,00	225	72	26,00
12x1	13,00	285	78	19,50
12x1,5	14,30	365	86	13,30
12x2,5	18,00	570	108	7,98
18x0,50	13,20	275	79	39,00
18x0,75	14,50	340	87	26,00
18x1	15,60	415	94	19,50
18x1,5	17,30	535	104	13,30
18x2,5	20,80	830	125	7,98
25x0,50	15,50	355	93	39,00
25x0,75	16,60	475	100	26,00
25x1	17,40	535	104	19,50
25x1,5	19,40	730	116	13,30
25x2,5	24,60	1150	148	7,98





CABLE STRUCTURE

Conductor	Electrolytic annealed, class 5 stranded plain copper wires (tinned conductor on request)
Insulation	PVC compound, TI52 type (EN 50290-2-21)
Core Identification	Up to including 10 cores DIN 47100 core colors Above 10 cores black cores with or without a green yellow core
Sheath	PVC compound, TM52 type (EN 50290-22)
Color	Grey

MAIN CHARACTERISTICS

Construction	Based on TS 13755, VDE 0812
General Requirements	EN 50290-2-20
Guide to Use	Based on. EN 50565-1/2, VDE 891 Part 1 to 10
Electrical Tests	EN 50395
Non - electrical Tests	EN 50396, EN 50290
Conductor Resistance	IEC 60228, VDE 0295, BS 6360
Flame Retardant	IEC 60332-1-2

OPERATING CHARACTERISTICS

Rated Voltage	300/500 V (U ₀ /U)
AC Test Voltage	2 kV
Working Temperature	-30°C to +70°C
Conductor Short-Circuit Temp.	160°C (Max. 5 sec)
Min. Bending Radius	Based on. VDE 0891 - Part 5
Current Carrying Capacities	Based on VDE 0298-4 Tab.11

For all sections :
Mutual capacitance : Approx 120 nF/km
Inductivity : Approx 0,65 mH/km

APPLICATIONS

These cables are used for data transmission, signalling and monitoring in automation, audio/vision, security and control systems indoor where flexibility is required.



FLAME RETARDANT

Cross Section (mm ²)	Nominal Overall Diameter (mm)	Approximate Weight (kg / km)	Min.Bending Radius (fixed installation) (mm)	Max. Resistance of Conductors at 20°C (ohm / km)
2x0,50	5,00	38	38	39,00
2x0,75	5,40	45	41	26,00
2x1	5,80	54	44	19,50
2x1,5	6,20	65	47	13,30
2x2,5	6,81	88	51	7,98
3x0,50	5,30	46	40	39,00
3x0,75	5,70	54	43	26,00
3x1	6,15	66	46	19,50
3x1,5	6,55	80	49	13,30
3x2,5	7,39	114	55	7,98
4x0,50	5,75	56	43	39,00
4x0,75	6,20	66	47	26,00
4x1	6,70	81	50	19,50
4x1,5	7,40	104	56	13,30
4x2,5	8,10	144	61	7,98
5x0,50	6,30	65	47	39,00
5x0,75	6,80	79	51	26,00
5x1	7,51	100	56	19,50
5x1,5	8,10	123	61	13,30
5x2,5	8,90	173	67	7,98
6x0,50	6,70	75	50	39,00
6x0,75	7,50	96	56	26,00
6x1	8,10	118	61	19,50
6x1,5	8,80	146	66	13,30
6x2,5	9,80	210	74	7,98
7x0,50	6,70	79	50	39,00
7x0,75	7,50	101	56	26,00
7x1	8,10	124	61	19,50
7x1,5	8,80	156	66	13,30
7x2,5	9,80	226	74	7,98
8x0,50	7,70	101	58	39,00
8x0,75	8,60	129	65	26,00

Cross Section (mm ²)	Nominal Overall Diameter (mm)	Approximate Weight (kg / km)	Min.Bending Radius (fixed installation) (mm)	Max. Resistance of Conductors at 20°C (ohm / km)
8x1	9,30	158	70	19,50
8x1,5	10,60	211	80	13,30
8x2,5	11,50	289	86	7,98
10x0,50	9,00	120	68	39,00
10x0,75	9,40	142	71	26,00
10x1	10,40	180	78	19,50
10x1,5	11,30	225	85	13,30
10x2,5	12,60	327	95	7,98
12x0,50	9,30	138	70	39,00
12x0,75	10,00	167	75	26,00
12x1	10,80	206	81	19,50
12x1,5	11,60	258	87	13,30
12x2,5	13,10	379	98	7,98
14x0,50	10,00	160	75	39,00
14x0,75	10,40	188	78	26,00
14x1	11,30	233	85	19,50
14x1,5	12,80	311	96	13,30
14x2,5	13,70	432	103	7,98
16x0,50	10,50	182	79	39,00
16x0,75	11,00	213	83	26,00
16x1	11,90	264	89	19,50
16x1,5	13,50	353	101	13,30
16x2,5	14,70	498	110	7,98
18x0,50	11,00	201	83	39,00
18x0,75	11,50	237	86	26,00
18x1	12,70	300	95	19,50
18x1,5	14,20	393	107	13,30
18x2,5	15,40	555	116	7,98
25x0,50	13,30	280	100	39,00
25x0,75	14,00	330	105	26,00
25x1	15,40	417	116	19,50
25x1,5	17,40	557	131	13,30

Cross Section (mm ²)	Nominal Overall Diameter (mm)	Approximate Weight (kg / km)	Min.Bending Radius (fixed installation) (mm)	Max. Resistance of Conductors at 20°C (ohm / km)
25x2,5	18,70	774	140	7,98
30x0,50	13,80	313	104	39,00
30x0,75	14,40	369	108	26,00
30x1	15,90	469	119	19,50
30x1,5	18,00	628	135	13,30
30x2,5	19,50	892	146	7,98



CABLE STRUCTURE

Conductor	Electrolytic annealed, class 5 stranded plain copper wires (tinned conductor on request)
Insulation	PVC compound, TI52 type (EN 50290-2-21)
Core Identification	Up to including 10 cores DIN 47100 core colors Above 10 cores black cores with or without a green yellow core
Seperator	Polyester tape
Screen	Tinned copper wire braiding
Sheath	PVC compound, TM52 type (EN 50290-22)
Color	Grey

MAIN CHARACTERISTICS

Construction	Based on TS 13755, VDE 0812
General Requirements	EN 50290-2-20
Guide to Use	Based on. EN 50565-1/2, VDE 891 Part 1 to 10
Electrical Tests	EN 50395
Non - electrical Tests	EN 50396, EN 50290
Conductor Resistance	IEC 60228, VDE 0295, BS 6360
Flame Retardant	IEC 60332-1-2

OPERATING CHARACTERISTICS

Rated Voltage	300/500 V (U ₀ /U)
AC Test Voltage	2 kV
Working Temperature	-30°C to +70°C
Conductor Short-Circuit Temp.	160°C (Max. 5 sec)
Min. Bending Radius	Based on. VDE 0891 - Part 5
Current Carrying Capacities	Based on VDE 0298-4 Tab.11

For all sections :

Mutual capacitance : Approx 120 nF/km

Inductivity : Approx 0,65 mH/km

APPLICATIONS

These cables are used for data transmission, signalling and monitoring in automation, audio/vision, security and control systems indoor where electromagnetic disturbances exists.



Cross Section (mm ²)	Nominal Overall Diameter (mm)	Approximate Weight (kg / km)	Min.Bending Radius (fixed installation) (mm)	Max. Resistance of Conductors at 20°C (ohm / km)
2x0,50	5,50	39	41	39,00
2x0,75	5,90	46	44	26,00
2x1	6,30	53	47	19,50
2x1,5	6,70	62	50	13,30
2x2,5	7,38	84	55	7,98
3x0,50	5,80	48	44	39,00
3x0,75	6,30	56	47	26,00
3x1	6,70	67	50	19,50
3x1,5	7,18	82	54	13,30
3x2,5	8,08	114	61	7,98
4x0,50	6,30	57	47	39,00
4x0,75	6,70	68	50	26,00
4x1	7,28	83	55	19,50
4x1,5	7,78	101	58	13,30
4x2,5	8,68	142	65	7,98
5x0,50	6,80	69	51	39,00
5x0,75	7,38	85	55	26,00
5x1	8,18	107	61	19,50
5x1,5	8,68	128	65	13,30
5x2,5	9,48	175	71	7,98
6x0,5	7,38	82	55	39,00
6x0,75	8,08	103	61	26,00
6x1	8,68	123	65	19,50
6x1,5	9,38	150	70	13,30
6x2,5	10,18	207	76	7,98
7x0,5	7,38	86	55	39,00
7x0,75	8,08	108	61	26,00
7x1	8,68	130	65	19,50
7x1,5	9,38	160	70	13,30
7x2,5	10,18	222	76	7,98
8x0,50	8,58	113	64	39,00
8x0,75	9,28	136	70	26,00

Cross Section (mm ²)	Nominal Overall Diameter (mm)	Approximate Weight (kg / km)	Min.Bending Radius (fixed installation) (mm)	Max. Resistance of Conductors at 20°C (ohm / km)
8x1	9,98	163	75	19,50
8x1,5	10,98	206	82	13,30
8x2,5	11,98	282	90	7,98
10x0,50	9,18	121	69	39,00
10x0,75	9,98	147	75	26,00
10x1	10,98	183	82	19,50
10x1,5	11,88	227	89	13,30
10x2,5	12,98	317	97	7,98
12x0,50	9,48	137	71	39,00
12x0,75	10,38	168	78	26,00
12x1	11,38	210	85	19,50
12x1,5	12,18	259	91	13,30
12x2,5	13,68	374	103	7,98
14x0,50	9,88	153	74	39,00
14x0,75	10,98	193	82	26,00
14x1	11,88	237	89	19,50
14x1,5	12,78	295	96	13,30
14x2,5	14,28	426	107	7,98
16x0,50	10,38	173	78	39,00
16x0,75	11,58	218	87	26,00
16x1	12,48	267	94	19,50
16x1,5	13,68	340	103	13,30
16x2,5	15,08	484	113	7,98
18x0,50	11,08	197	83	39,00
18x0,75	12,08	242	91	26,00
18x1	13,08	297	98	19,50
18x1,5	14,38	378	108	13,30
18x2,5	15,78	539	118	7,98
19x0,50	11,08	200	83	39,00
19x0,75	12,08	246	91	26,00
19x1	13,08	304	98	19,50
19x1,5	14,38	388	108	13,30

Cross Section (mm ²)	Nominal Overall Diameter (mm)	Approximate Weight (kg / km)	Min.Bending Radius (fixed installation) (mm)	Max. Resistance of Conductors at 20°C (ohm / km)
19x2,5	15,78	556	118	7,98
24x0,50	12,78	247	96	39,00
24x0,75	14,18	312	106	26,00
24x1	15,38	385	115	19,50
24x1,5	16,88	490	127	13,30
24x2,5	18,90	723	142	7,98
25x0,50	13,08	263	98	39,00
25x0,75	14,58	333	109	26,00
25x1	15,78	409	118	19,50
25x1,5	17,18	520	129	13,30
25x2,5	19,40	766	146	7,98
30x0,50	13,68	300	103	39,00
30x0,75	14,98	372	112	26,00
30x1	16,48	469	124	19,50
30x1,5	17,78	590	133	13,30
30x2,5	20,00	874	150	7,98
32x0,50	14,18	319	106	39,00
32x0,75	15,58	397	117	26,00
32x1	17,08	500	128	19,50
32x1,5	18,60	637	140	13,30
32x2,5	20,80	932	156	7,98
36x0,50	14,68	352	110	39,00
36x0,75	16,28	446	122	26,00
36x1	17,68	554	133	19,50
36x1,5	19,50	717	146	13,30
36x2,5	21,70	1048	163	7,98
40x0,50	15,28	390	115	39,00
40x0,75	16,98	495	127	26,00
40x1	18,50	623	139	19,50
40x1,5	20,20	795	152	13,30
40x2,5	22,60	1165	170	7,98



CABLE STRUCTURE

Conductor	Electrolytic annealed, class 5 stranded plain copper wires (tinned conductor on request)
Insulation	Halogen-Free compound (EN 50290-2-26)
Core Identification	Up to including 10 cores DIN 47100 core colors Above 10 cores black cores with or without a green yellow core
Sheath	Halogen-Free compound (EN 50290-2-27)
Color	Grey

MAIN CHARACTERISTICS

Construction	Based on TS 13755, VDE 0812
General Requirements	EN 50290-2-20
Guide to Use	Based on. EN 50565-1/2, VDE 891 Part 1 to 10
Electrical Tests	EN 50395
Non - electrical Tests	EN 50396, EN 50290
Conductor Resistance	IEC 60228, VDE 0295, BS 6360
Flame Retardant	IEC 60332-1-2, IEC 60332-3-24 Cat C
Halogen Content	IEC 60754-1/2
Smoke Density	IEC 61034-1/2

OPERATING CHARACTERISTICS

Rated Voltage	300/500 V (U ₀ /U)
AC Test Voltage	2 kV
Working Temperature	-30°C to +70°C
Conductor Short-Circuit Temp.	160°C (Max. 5 sec)
Min. Bending Radius	Based on. VDE 0891 - Part 5
Current Carrying Capacities	Based on VDE 0298-4 Tab.11

For all sections :
Mutual capacitance : Approx 120 nF/km
Inductivity : Approx 0,65 mH/km

APPLICATIONS

These cables are used for data transmission, signalling and monitoring in automation, audio/vision, security and control systems in closed areas when higher safety required in case of fire.



Cross Section (mm ²)	Nominal Overall Diameter (mm)	Approximate Weight (kg / km)	Min.Bending Radius (fixed installation) (mm)	Max. Resistance of Conductors at 20°C (ohm / km)
2x0,50	5,00	36	38	39,00
2x0,75	5,40	45	41	26,00
2x1	5,80	53	44	19,50
2x1,5	6,40	68	48	13,30
2x2,5	7,40	97	56	7,98
3x0,50	5,30	43	40	39,00
3x0,75	5,80	55	44	26,00
3x1	6,20	65	47	19,50
3x1,5	6,80	84	51	13,30
3x2,5	7,90	122	59	7,98
4x0,50	58,00	53	435	39,00
4x0,75	6,20	66	47	26,00
4x1	6,70	80	50	19,50
4x1,5	7,70	109	58	13,30
4x2,5	8,60	152	65	7,98
5x0,50	6,20	62	47	39,00
5x0,75	6,80	80	51	26,00
5x1	7,50	100	56	19,50
5x1,5	8,30	130	62	13,30
5x2,5	9,40	184	71	7,98
6x0,50	6,70	73	50	39,00
6x0,75	7,50	97	56	26,00
6x1	8,10	117	61	19,50
6x1,5	9,00	154	68	13,30
6x2,5	10,40	224	78	7,98
7x0,50	6,70	76	50	39,00
7x0,75	7,50	102	56	26,00
7x1	8,10	124	61	19,50
7x1,5	9,00	163	68	13,30
7x2,5	10,40	240	78	7,98
8x0,50	7,70	102	58	39,00
8x0,75	8,40	131	63	26,00

Cross Section (mm ²)	Nominal Overall Diameter (mm)	Approximate Weight (kg / km)	Min.Bending Radius (fixed installation) (mm)	Max. Resistance of Conductors at 20°C (ohm / km)
8x1	9,10	158	68	19,50
8x1,5	10,30	214	77	13,30
8x2,5	11,70	303	88	7,98
10x0,50	8,60	111	65	39,00
10x0,75	9,40	143	71	26,00
10x1	10,40	180	78	19,50
10x1,5	11,60	236	87	13,30
10x2,5	13,40	346	101	7,98
12x0,50	8,90	125	67	39,00
12x0,75	10,00	168	75	26,00
12x1	10,80	204	81	19,50
12x1,5	12,20	276	92	13,30
12x2,5	13,90	398	104	7,98
14x0,50	9,30	142	70	39,00
14x0,75	10,40	190	78	26,00
14x1	11,30	232	85	19,50
14x1,5	12,80	315	96	13,30
14x2,5	14,80	462	111	7,98
16x0,50	10,00	163	75	39,00
16x0,75	11,00	214	83	26,00
16x1	11,90	260	89	19,50
16x1,5	13,50	354	101	13,30
16x2,5	15,60	520	117	7,98
18x0,50	10,50	178	79	39,00
18x0,75	11,50	234	86	26,00
18x1	12,70	291	95	19,50
18x1,5	14,20	390	107	13,30
18x2,5	16,40	574	123	7,98
25x0,50	12,70	250	95	39,00
25x0,75	14,00	328	105	26,00
25x1	15,40	408	116	19,50
25x1,5	17,40	553	131	13,30

Cross Section (mm ²)	Nominal Overall Diameter (mm)	Approximate Weight (kg / km)	Min.Bending Radius (fixed installation) (mm)	Max. Resistance of Conductors at 20°C (ohm / km)
25x2,5	20,10	812	151	7,98
30x0,50	13,10	280	98	39,00
30x0,75	14,40	370	108	26,00
30x1	15,90	460	119	19,50
30x1,5	18,00	627	135	13,30
30x2,5	20,80	927	156	7,98



CABLE STRUCTURE

Conductor	Electrolytic annealed, class 5 stranded plain copper wires (tinned conductor on request)
Insulation	Halogen-Free compound (EN 50290-2-26)
Seperator	Polyester tape
Core Identification	Up to including 10 cores DIN 47100 core colors Above 10 cores black cores with or without a green yellow core
Screen	Tinned copper wire braiding
Sheath	Halogen-Free compound (EN 50290-2-27)
Color	Grey

MAIN CHARACTERISTICS

Construction	Based on TS 13755, VDE 0812
General Requirements	EN 50290-2-20
Guide to Use	Based on. EN 50565-1/2, VDE 891 Part 1 to 10
Electrical Tests	EN 50395
Non - electrical Tests	EN 50396, EN 50290
Conductor Resistance	IEC 60228, VDE 0295, BS 6360
Flame Retardant	IEC 60332-1-2, IEC 60332-3-24 Cat C
Halogen Content	IEC 60754-1/2
Smoke Density	IEC 61034-1/2

OPERATING CHARACTERISTICS

Rated Voltage	300/500 V (U ₀ /U)
AC Test Voltage	2 kV
Working Temperature	-30°C to +70°C
Conductor Short-Circuit Temp.	160°C (Max. 5 sec)
Min. Installation Temp.	0°C
Min. Bending Radius	Based on. VDE 0891 - Part 5
Current Carrying Capacities	Based on VDE 0298-4 Tab.11

For all sections :
Mutual capacitance : Approx 120 nF/km
Inductivity : Approx 0,65 mH/km

APPLICATIONS

These cables are used for data transmission, signalling and monitoring in automation, audio/vision, security and control systems indoor where electromagnetic disturbances exists and when higher safety required in case of fire.



Cross Section (mm ²)	Nominal Overall Diameter (mm)	Approximate Weight (kg / km)	Min.Bending Radius (fixed installation) (mm)	Max. Resistance of Conductors at 20°C (ohm / km)
2x0,50	5,50	40	41	39,00
2x0,75	5,90	47	44	26,00
2x1	6,30	55	47	19,50
2x1,5	6,70	64	50	13,30
2x2,5	7,38	87	55	7,98
3x0,50	5,80	49	44	39,00
3x0,75	6,30	58	47	26,00
3x1	6,70	69	50	19,50
3x1,5	7,18	85	54	13,30
3x2,5	8,08	118	61	7,98
4x0,50	6,30	59	47	39,00
4x0,75	6,70	70	50	26,00
4x1	7,28	86	55	19,50
4x1,5	7,78	104	58	13,30
4x2,5	8,68	146	65	7,98
5x0,50	6,80	71	51	39,00
5x0,75	7,38	88	55	26,00
5x1	8,18	110	61	19,50
5x1,5	8,68	132	65	13,30
5x2,5	9,48	180	71	7,98
6x0,50	7,40	85	56	39,00
6x0,75	8,08	106	61	26,00
6x1	8,68	127	65	19,50
6x1,5	9,38	155	70	13,30
6x2,5	10,18	213	76	7,98
7x0,50	7,40	89	56	39,00
7x0,75	8,08	111	61	26,00
7x1	8,68	134	65	19,50
7x1,5	9,38	165	70	13,30
7x2,5	10,18	229	76	7,98
8x0,50	8,60	116	65	39,00
8x0,75	9,28	140	70	26,00

Cross Section (mm ²)	Nominal Overall Diameter (mm)	Approximate Weight (kg / km)	Min.Bending Radius (fixed installation) (mm)	Max. Resistance of Conductors at 20°C (ohm / km)
8x1	9,98	168	75	19,50
8x1,5	10,98	212	82	13,30
8x2,5	11,98	291	90	7,98
10x0,75	9,98	152	75	26,00
10x1	10,98	189	82	19,50
10x1,5	11,88	234	89	13,30
10x2,5	12,98	327	97	7,98
12x0,75	10,38	173	78	26,00
12x1	11,38	216	85	19,50
12x1,5	12,18	267	91	13,30
12x2,5	13,68	386	103	7,98
14x0,75	10,98	199	82	26,00
14x1	11,88	244	89	19,50
14x1,5	12,78	304	96	13,30
14x2,5	14,28	439	107	7,98
16x0,75	11,58	225	87	26,00
16x1	12,48	275	94	19,50
16x1,5	13,68	350	103	13,30
16x2,5	15,08	499	113	7,98
18x0,75	12,08	249	91	26,00
18x1	13,08	306	98	19,50
18x1,5	14,38	390	108	13,30
18x2,5	15,78	556	118	7,98
25x0,75	14,58	343	109	26,00
25x1	15,78	422	118	19,50
25x1,5	17,20	520	129	13,30
25x2,5	19,40	790	146	7,98
30x0,75	14,98	384	112	26,00
30x1	16,48	484	124	19,50
30x1,5	17,80	590	134	13,30
30x2,5	20,00	901	150	7,98





CABLE STRUCTURE

Conductor	Electrolytic annealed, class 5 stranded plain copper wires (tinned conductor on request)
Insulation	Halogen-Free compound, TI6 type (EN 50363-7)
Core Identification	JZ: Black cores with a green yellow core OZ: Black cores without a green yellow core
Sheath	Halogen-Free compound, TM7 type (EN 50363-8)
Color	Grey

MAIN CHARACTERISTICS

Construction	Based on EN 50525-3-11, Based on BA 14122019, TS 13755
General Requirements	EN 50525-1, VDE 0812, EN 50575
Guide to Use	EN 50565-1/2
Electrical Tests	EN 50395
Non - electrical Tests	EN 50396
Conductor Resistance	IEC 60228, VDE 0295, BS 6360
Flame Retardant	IEC 60332-1-2, IEC 60332-3-24 Cat C
Halogen Content	IEC 60754-1/2
Smoke Density	IEC 61034-1/2

OPERATING CHARACTERISTICS

Rated Voltage	300/500 V (U ₀ /U)
AC Test Voltage	2 kV
Working Temperature	
<i>In Flexing Use</i>	-5°C to +70°C
<i>In Fixed Use</i>	-30°C to +70°C
Conductor Short-Circuit Temp.	150°C (Max. 5 sec)
Min. Installation Temp.	-5 °C
Min. Bending Radius	Based on EN 50565-1 Tab. 3
Current Carrying Capacities	Based on VDE 0298-4 Tab.11

APPLICATIONS

These cables are used for control, measuring and monitoring in engineering projects and various electronic systems in closed areas when higher safety required in case of fire.



FLAME RETARDANT



HALOGEN-FREE



LOW SMOKE

Cross Section (mm ²)	Nominal Overall Diameter (mm)	Approximate Weight (kg / km)	Min.Bending Radius (fixed installation) (mm)	Max. Resistance of Conductors at 20°C (ohm / km)
2x0,50	5,00	37	38	39,00
2x0,75	5,40	50	41	26,00
2x1	5,80	55	44	19,50
2x1,5	6,20	75	47	13,30
2x2,5	6,80	90	51	7,98
3x0,50	5,29	46	40	39,00
3x0,75	5,70	60	43	26,00
3x1	6,10	65	46	19,50
3x1,5	6,60	95	50	13,30
3x2,5	7,50	120	56	7,98
4x0,50	5,75	55,29	43	39,00
4x0,75	6,20	65,96	47	26,00
4x1	6,70	85	50	19,50
4x1,5	7,40	120	56	13,30
4x2,5	8,10	150	61	7,98
5x0,50	6,30	64	47	39,00
5x0,75	6,80	78	51	26,00
5x1	7,50	105	56	19,50
5x1,5	8,10	140	61	13,30
5x2,5	9,30	190	70	7,98
6x0,50	6,70	75	50	39,00
6x0,75	7,50	95	56	26,00
6x1	8,10	116	61	19,50
6x1,5	8,80	144	66	13,30
6x2,5	9,80	207	74	7,98
7x0,50	6,70	80	50	39,00
7x0,75	7,50	100	56	26,00
7x1	8,10	125	61	19,50
7x1,5	8,80	153	66	13,30
7x2,5	9,80	225	74	7,98
8x0,50	7,70	101	58	39,00
8x0,75	8,60	128	65	26,00

Cross Section (mm ²)	Nominal Overall Diameter (mm)	Approximate Weight (kg / km)	Min.Bending Radius (fixed installation) (mm)	Max. Resistance of Conductors at 20°C (ohm / km)
8x1	9,30	156	70	19,50
8x1,5	10,60	209	80	13,30
8x2,5	11,50	285	86	7,98
10x0,50	8,60	110	65	39,00
10x0,75	9,40	142	71	26,00
10x1	10,40	180	78	19,50
10x1,5	11,30	221	85	13,30
10x2,5	12,60	320	95	7,98
12x0,50	8,90	125	67	39,00
12x0,75	10,00	167	75	26,00
12x1	10,80	206	81	19,50
12x1,5	11,60	260	87	13,30
12x2,5	13,10	372	98	7,98
14x0,50	9,30	142	70	39,00
14x0,75	10,40	187	78	26,00
14x1	11,30	233	85	19,50
14x1,5	12,80	310	96	13,30
14x2,5	13,70	426	103	7,98
16x0,50	10,00	166	75	39,00
16x0,75	11,00	212	83	26,00
16x1	11,90	265	89	19,50
16x1,5	13,50	350	101	13,30
16x2,5	14,70	500	110	7,98
18x0,50	10,50	185	79	39,00
18x0,75	11,50	237	86	26,00
18x1	12,70	301	95	19,50
18x1,5	14,20	393	107	13,30
18x2,5	15,40	552	116	7,98
25x0,50	12,70	260	95	39,00
25x0,75	14,00	333	105	26,00
25x1	15,40	420	116	19,50
25x1,5	17,40	560	131	13,30
25x2,5	18,70	775	140	7,98



618

6128



CABLE STRUCTURE

Conductor	Electrolytic annealed, class 5 stranded plain copper wires (tinned conductor on request)
Insulation	Halogen-Free compound, T16 type (EN 50363-7)
Core Identification	JZ: Black cores with a green yellow core OZ: Black cores without a green yellow core
Seperator	Polyester tape
Screen	Tinned copper wire braiding
Sheath	Halogen-Free compound, TM7 type (EN 50363-8)
Color	Grey

MAIN CHARACTERISTICS

Construction	Based on EN 50525-3-11, Based on BA 14122019, TS 13755
General Requirements	EN 50525-1, VDE 0812, EN 50575
Guide to Use	EN 50565-1/2
Electrical Tests	EN 50395
Non - electrical Tests	EN 50396
Conductor Resistance	IEC 60228, VDE 0295, BS 6360
Flame Retardant	IEC 60332-1-2, IEC 60332-3-24 Cat C
Halogen Content	IEC 60754-1/2
Smoke Density	IEC 61034-1/2

OPERATING CHARACTERISTICS

Rated Voltage	300/500 V (U ₀ /U)
AC Test Voltage	2 kV
Working Tempetature	
<i>In Flexing Use</i>	-5°C to +70°C
<i>In Fixed Use</i>	-30°C to +70°C
Conductor Short-Circuit Temp.	150°C (Max. 5 sec)
Min. Installation Temp.	-5 °C
Min. Bending Radius	Based on EN 50565-1 Tab. 3
Current Carrying Capacities	Based on VDE 0298-4 Tab.11

APPLICATIONS

These cables are used for control, measuring and monitoring in engineering projects and various electronic systems in closed areas where electromagnetic disturbances exists and when higher safety required in case of fire.



Cross Section (mm ²)	Nominal Overall Diameter (mm)	Approximate Weight (kg / km)	Min.Bending Radius (fixed installation) (mm)	Max. Resistance of Conductors at 20°C (ohm / km)
2x0,50	5,50	40	41	39,00
2x0,75	5,90	46	44	26,00
2x1	6,30	54	47	19,50
2x1,5	6,70	63	50	13,30
2x2,5	7,40	86	56	7,98
3x0,50	5,80	49	44	39,00
3x0,75	6,30	58	47	26,00
3x1	6,70	68	50	19,50
3x1,5	7,20	83	54	13,30
3x2,5	8,10	116	61	7,98
4x0,50	6,30	58	47	39,00
4x0,75	6,70	69	50	26,00
4x1	7,30	85	55	19,50
4x1,5	7,80	102	59	13,30
4x2,5	8,70	143	65	7,98
5x0,50	6,80	70	51	39,00
5x0,75	7,40	86	56	26,00
5x1	8,20	107	62	19,50
5x1,5	8,70	130	65	13,30
5x2,5	9,50	176	71	7,98
6x0,50	7,40	84	56	39,00
6x0,75	8,10	104	61	26,00
6x1	8,70	125	65	19,50
6x1,5	9,40	152	71	13,30
6x2,5	10,20	208	77	7,98
7x0,50	7,40	87	56	39,00
7x0,75	8,10	108	61	26,00
7x1	8,70	131	65	19,50
7x1,5	9,40	161	71	13,30
7x2,5	10,20	223	77	7,98
8x0,50	8,60	113	65	39,00
8x0,75	9,30	137	70	26,00

Cross Section (mm ²)	Nominal Overall Diameter (mm)	Approximate Weight (kg / km)	Min.Bending Radius (fixed installation) (mm)	Max. Resistance of Conductors at 20°C (ohm / km)
8x1	10,00	164	75	19,50
8x1,5	11,00	206	83	13,30
8x2,5	12,00	283	90	7,98
10x0,50	9,20	123	69	39,00
10x0,75	10,00	148	75	26,00
10x1	11,00	185	83	19,50
10x1,5	11,90	228	89	13,30
10x2,5	13,00	319	98	7,98
12x0,50	9,50	138	71	39,00
12x0,75	10,40	169	78	26,00
12x1	11,40	210	86	19,50
12x1,5	12,20	260	92	13,30
12x2,5	13,70	376	103	7,98
14x0,50	9,90	155	74	39,00
14x0,75	11,00	194	83	26,00
14x1	11,90	237	89	19,50
14x1,5	12,80	295	96	13,30
14x2,5	14,30	427	107	7,98
16x0,50	10,40	173	78	39,00
16x0,75	11,60	219	87	26,00
16x1	12,50	268	94	19,50
16x1,5	13,70	340	103	13,30
16x2,5	15,10	485	113	7,98
18x0,50	11,10	198	83	39,00
18x0,75	12,10	243	91	26,00
18x1	13,10	298	98	19,50
18x1,5	14,40	379	108	13,30
18x2,5	15,80	541	119	7,98
25x0,50	13,10	263	98	39,00
25x0,75	14,60	334	110	26,00
25x1	15,80	411	119	19,50
25x1,5	17,20	521	129	13,30

Cross Section (mm ²)	Nominal Overall Diameter (mm)	Approximate Weight (kg / km)	Min.Bending Radius (fixed installation) (mm)	Max. Resistance of Conductors at 20°C (ohm / km)
25x2,5	19,40	767	146	7,98
30x0,50	13,70	301	103	39,00
30x0,75	15,00	334	113	26,00
30x1	16,50	470	124	19,50
30x1,5	17,80	591	134	13,30
30x2,5	20,00	875	150	7,98



CABLE STRUCTURE

Conductor	Electrolytic annealed, class 5 stranded plain copper wires (tinned conductor on request)
Insulation	PVC compound, T12 type (EN 50363-3)
Sheath	PVC compound, TM2 type (EN 50363-4-1)
Color	Black

MAIN CHARACTERISTICS

Construction	EN 50214, IEC 60227-6, VDE 0283-2
General Requirements	EN 50525-1
Guide to Use	EN 50565-1/2, EN 81 series (safety rules for the construction and installation of lifts)
Electrical Tests	EN 50395
Non - electrical Tests	EN 50396
Conductor Resistance	IEC 60228, VDE 0295, BS 6360
Flame Retardant	IEC 60332-1-2

OPERATING CHARACTERISTICS

Rated Voltage	450/750 V (U ₀ /U)
AC Test Voltage	2 kV
Working Temperature	
<i>In Flexing Use</i>	-5°C to +70°C
<i>In Fixed Use</i>	-30°C to +70°C
Conductor Short-Circuit Temp.	150°C (Max. 5 sec)
Min. Installation Temp.	5°C
Min. Bending Radius	EN 50565-1 Tab. 3
Current Carrying Capacities	VDE 0298-4 Tab.11

APPLICATIONS

These power and control flat cables can be used on festoons systems on handling equipment. as overhead cranes. They are Used as control cables in lifts, elevators and conveyor systems. The hanging length of the cable can reach up to 35m and its pull out speed can reach up to 1.6 m/s (overlying cables is not recommended when installing). Üntel Kablo certifies the usage of this cable permanently submerged in water up to 10 bar (100 mts) and IPX8 tested by TUV



FLAT DESIGN



SUBMERSION
100 MT (ADB)



UV RESISTANT



WATER
RESISTANT



SUBMERSION
100 MT (ADB)

Cross Section (mm ²)	Nominal Overall Diameter (mm)	Approximate Weight (kg / km)	Min.Bending Radius (free movement) (mm)	Max. Resistance of Conductors at 20°C (ohm / km)
3x1,5	5,50 x 14,20	145	28	13,30
3x2,5	5,60 x 14,40	168	28	7,98
3x4	7,10 x 15,70	243	36	4,95
3x6	8,40 x 17,60	335	42	3,30
3x10	9,50 x 22,50	507	48	1,91
3x16	10,70 x 25,20	706	54	1,21
3x25	13,40 x 32,20	1084	80	0,78
3x35	14,50 x 35,10	1380	87	0,55
3x50	16,90 x 42,20	1947	101	0,554
3x70	18,00 x 46,00	2532	108	0,386
3x95	20,70 x 53,30	3319	124	0,272
3x120	24,40 x 64,50	4511	146	0,206
3x150	26,60 x 71,80	5508	160	0,161
3x10+6	8,90 x 28,00	598	45	0,129
3x16+10	9,80 x 31,20	824	49	1,21
3x25+16	12,40 x 40,80	1297	74	0,78
3x35+25	13,60 x 45,30	1692	82	0,554
3x50+25	17,00 x 56,20	2456	102	0,386
3x70+35	19,40 x 64,50	3373	116	0,272
3x95+50	21,00 x 77,40	4394	126	0,206
3x120+70	25,00 x 81,00	5769	150	0,161
3x150+70	26,60 x 95,90	6899	160	0,129
3x150+95	26,60 x 95,90	7024	160	0,129
4x1,5	5,30 x 14,90	154	27	13,30
4x2,5	5,40 x 17,20	202	27	7,98
4x4	6,30 x 19,20	282	32	4,95
4x6	6,80 x 21,20	367	34	3,30
4x10	8,90 x 28,00	624	45	1,91
4x16	9,80 x 28,00	861	49	1,21
4x25	12,40 x 40,80	1342	74	0,78
4x35	13,60 x 45,30	1747	82	0,55
4x50	17,00 x 56,20	2603	82	0,386

Cross Section (mm ²)	Nominal Overall Diameter (mm)	Approximate Weight (kg / km)	Min.Bending Radius (free movement) (mm)	Max. Resistance of Conductors at 20°C (ohm / km)
4x70	19,40 x 64,50	3597	116	0,272
4x95	21,00 x 77,40	4657	126	0,206
4x120	24,80 x 84,20	5999	149	0,161
4x150	26,60 x 95,90	7350	160	0,129
5x1,5	4,90 x 17,70	176	25	13,30
5x2,5	5,40 x 20,60	244	27	7,98
5x4	6,60 x 24,60	370	33	4,95
5x6	6,80 x 25,60	450	34	3,30
5x10	8,80 x 34,20	792	44	1,91
5x16	9,60 x 37,60	1072	48	1,21
7x1,5	5,70 x 27,20	296	29	13,30
7x2,5	5,40 x 30,40	355	27	7,98
7x4	7,00 x 32,90	522	35	4,95
7x6	6,80 x 37,40	645	34	3,30
8x1,5	5,10 x 27,50	282	26	13,30
8x2,5	5,40 x 32,30	386	27	7,98
10x1,5	5,20 x 34,20	357	26	13,30
12x1,5	5,20 x 39,80	419	26	13,30
12x2,5	5,40 x 47,40	571	27	7,98
14x1,5	5,60 x 50,70	552	28	13,30
16x1,5	5,20 x 53,00	558	26	13,30
16x2,5	5,40 x 62,50	756	27	7,98
24x1,5	4,90 x 77,60	787	25	13,30
24x2,5	6,00 x 96,60	1244	30	7,98





CABLE STRUCTURE

Conductor	Electrolytic annealed, Class 5 or Class 6 stranded plain copper wires (tinned conductor on request)
Insulation	XLPE compound (Cross-linked polyethylene), 2XII type (VDE 0276-604, IEC 60502-1) Black cores number coded with a green yellow core
Seperator	Textile tape
Suspension Support	Galvanized steel wire ropes at both sides
Sheath	Special PVC compound
Color	Black or Yellow

MAIN CHARACTERISTICS

Construction	Based on EN 50525-2-11, Based on. VDE 0250, VDE 0295
General Requirements	EN 50525-1
Guide to Use	EN 50565-1/2
Electrical Tests	EN 50395
Non - electrical Tests	EN 50396
Conductor Resistance	IEC 60228, VDE 0295, BS 6360
Flame Retardant	IEC 60332-1-2
Oil Resistant	IEC 60811-404, VDE 0473-811-404

OPERATING CHARACTERISTICS

Rated Voltage	300/500 V (U ₀ /U)
AC Test Voltage	2 kV
Operating Temperature	
<i>In Flexing Use</i>	-25°C to +90°C
<i>In Fixed Use</i>	-40°C to +90°C
Conductor Short-Circuit Temp.	250°C (Max. 5 sec)
Min. Installation Temp.	-5°C
Min. Bending Radius	
<i>Flexible Use</i>	10 x Outer Diameter
<i>Fixed Installation</i>	4 x Outer Diameter
Max. Suspended Height	80m
Current Carrying Capacities	Based on. VDE 0298-4 Tab.11

APPLICATIONS

These pendant cables are used as control or feeder cables in lifts and hoists. The two steel load bearing elements can be detached without damaging the outer sheath and fixed independently from the cable gland. The cable offers high flexibility at lower temperatures due to the quality of material used in the construction. The two special torsion-free steel supporting elements found parallel on both sides of the outer jacket are. These cables are not suitable for drum reeling installations.



Cross Section (mm ²)	Nominal Overall Diameter (mm)	Approximate Weight (kg / km)	Min.Bending Radius (free movement) (mm)	Max. Resistance of Conductors at 20°C (ohm / km)
5x1,5	10,50 x 20,00	255	105	1,91
6x1,5	11,20 x 21,00	275	112	1,21
8x1,5	13,50 x 22,50	335	135	0,780
10x1,5	14,50 x 23,00	380	145	0,554
12x1,5	15,00 x 23,50	415	150	0,386
14x1,5	15,50 x 24,50	455	155	0,272
16x1,5	16,00 x 25,00	495	160	0,206
20x1,5	17,50 x 27,50	610	175	0,161
24x1,5	19,50 x 29,50	645	195	0,129



CABLE STRUCTURE

Conductor	Electrolytic annealed, class 5 stranded plain copper wires (tinned conductor on request)
Insulation	PVC compound, T12 type (EN 50363-3) Black cores number coded with a green yellow core
Sheath	Thermoplastic polyurethane TMPU (EN 50363-10-2)
Color	Orange or Grey or Black other colors on request

MAIN CHARACTERISTICS

Construction	Based on EN 50525-2-21, VDE 0285, VOE 0250
General Requirements	EN 50525-1
Guide to Use	EN 50565-1/2
Electrical Tests	EN 50395
Non - electrical Tests	EN 50396
Conductor Resistance	IEC 60228, VDE 0295, BS 6360
Oil Resistant	IEC 60811-404, VDE 0473-811-404

OPERATING CHARACTERISTICS

Rated Voltage	300/500 V (U ₀ /U)
AC Test Voltage	2 kV
Operating Temperature	
<i>In Flexing Use</i>	-5°C to +70°C
<i>In Fixed Use</i>	-40°C to +80°C
Conductor Short-Circuit Temp.	160°C (Max. 5 sec)
Min. Installation Temp.	-40°C
Min. Bending Radius	
<i>Flexible Use</i>	10 x Outer Diameter
<i>Fixed Installation</i>	4 x Outer Diameter
Current Carrying Capacities	Based on VDE 0298-4 Tab.11 and Tab.13

APPLICATIONS

These polyurethane sheathed cables are used in electrical tools, mobile equipments, machines, production lines, industrial machinery and movable appliances which work under normal mechanical stress. This cable is also very suitable for oily wet areas within production lines and agricultural equipments and machineries. Thanks to its characteristics they have high resistance to abrasion and tear.



Cross Section (mm ²)	Nominal Overall Diameter (mm)	Approximate Weight (kg / km)	Min.Bending Radius (fixed installation) (mm)	Max. Resistance of Conductors at 20°C (ohm / km)
2x0,50	5,00	26	20	39,00
2x0,75	5,60	35	22	26,00
2x1	6,00	41	24	19,50
2x1,5	6,60	52	26	13,30
3x0,50	5,30	35	21	39,00
3x0,75	6,00	45	24	26,00
3x1	6,40	54	26	19,50
3x1,5	7,00	70	28	13,30
4x0,50	6,00	44	24	39,00
4x0,75	6,40	56	26	26,00
4x1	6,90	67	28	19,50
4x1,5	7,70	88	31	13,30
5x0,50	6,50	54	26	39,00
5x0,75	7,00	69	28	26,00
5x1	7,60	84	30	19,50
5x1,5	8,60	114	34	13,30
7x0,50	6,90	67	28	39,00
7x0,75	7,50	87	30	26,00
7x1	8,30	109	33	19,50
7x1,5	9,20	145	37	13,30
12x0,50	9,10	111	36	39,00
12x0,75	10,00	146	40	26,00
12x1	11,00	182	44	19,50
12x1,5	12,20	243	49	13,30
18x0,50	10,50	160	42	39,00
18x0,75	11,70	216	47	26,00
18x1	12,70	264	51	19,50
18x1,5	14,40	361	58	13,30
21x0,50	11,30	183	45	39,00
21x0,75	12,40	243	50	26,00
21x1	13,40	298	54	19,50
21x1,5	15,20	408	61	13,30
25x0,50	12,70	218	51	39,00
25x0,75	14,20	296	57	26,00
25x1	15,40	363	62	19,50
25x1,5	17,40	496	70	13,30



CABLE STRUCTURE

Conductor	Electrolytic annealed, class 5 stranded plain copper wires (tinned conductor on request)
Insulation	PVC compound, T12 type (EN 50363-3) Black cores number coded with a green-yellow core
Seperator	Polyester tape or textile tape
Screen	Tinned copper wire braiding
Outer Sheath	Thermoplastic polyurethane TMPU (EN 50363-10-2)
Color	Grey, Orange or Black Other colors on request

MAIN CHARACTERISTICS

Construction	Based on EN 50525-2-21, VDE 0285, VDE 0250
General Requirements	EN 50525-1
Guide to Use	EN 50565-1/2
Electrical Tests	EN 50395
Non - electrical Tests	EN 50396
Conductor Resistance	IEC 60228, VDE 0295, BS 6360
Oil Resistant	IEC 60811-404, VDE 0473-811-404

OPERATING CHARACTERISTICS

Rated Voltage	300 /500 V (U ₀ /U)
AC Test Voltage	2 kV
Working Tempetature	
<i>In Flexing Use</i>	-5°C to +70°C
<i>In Fixed Use</i>	-40°C to +80°C
Conductor Short-Circuit Temp.	160°C (Max. 5 sec)
Min. Installation Temp.	-40°C
Min. Bending Radius	
<i>Flexible Use</i>	12,5 x Outer Diameter
<i>Fixed Installation</i>	5 x Outer Diameter
Current Carrying Capacities	Based on VDE 0298-4 Tab.11 and Tab.13

APPLICATIONS

These polyurethane sheathed cables are used in electrical tools, mobile equipments, machines, production lines, industrial machinery and movable appliances which work under normal mechanical stress. This cable is also very suitable for oily wet areas within production lines and agricultural equipments and machineries. Thanks to it's characteristics they have high resistance to abrasion and tear.



Cross Section (mm ²)	Nominal Overall Diameter (mm)	Approximate Weight (kg / km)	Min.Bending Radius (fixed installation) (mm)	Max. Resistance of Conductors at 20°C (ohm / km)
2x0,50	5,90	32	30	39,00
2x0,75	6,30	38	32	26,00
2x1	6,70	45	34	19,50
2x1,5	7,30	56	37	13,30
3x0,50	6,20	40	31	39,00
3x0,75	6,70	50	34	26,00
3x1	7,10	58	36	19,50
3x1,5	7,70	74	39	13,30
4x0,50	6,70	48	34	39,00
4x0,75	7,10	60	36	26,00
4x1	7,60	71	38	19,50
4x1,5	8,60	96	43	13,30
5x0,50	7,20	58	36	39,00
5x0,75	7,70	74	39	26,00
5x1	8,50	92	43	19,50
5x1,5	9,30	120	47	13,30
7x0,50	7,60	71	38	39,00
7x0,75	8,40	95	42	26,00
7x1	9,00	115	45	19,50
7x1,5	10,00	150	50	13,30
12x0,50	9,80	116	49	39,00
12x0,75	10,70	151	54	26,00
12x1	11,70	187	59	19,50
12x1,5	13,00	250	65	13,30
18x0,50	11,40	170	57	39,00
18x0,75	12,40	222	62	26,00
18x1	13,70	275	69	19,50
18x1,5	15,20	370	76	13,30
21x0,50	12,00	190	60	39,00
21x0,75	13,20	250	66	26,00
21x1	14,40	310	72	19,50
21x1,5	16,00	415	80	13,30
25x0,50	13,70	230	69	39,00
25x0,75	15,00	305	75	26,00
25x1	16,40	377	82	19,50
25x1,5	18,20	505	91	13,30



CABLE STRUCTURE

Conductor	Electrolytic annealed, class 5 stranded plain copper wires (tinned conductor on request)
Insulation	Special thermoplastic polyester elastomer, TPE-E Black cores number coded with a green-yellow core
Seperator	Textile tape or polyester tape
Outer Sheath	Thermoplastic polyurethane TPU (EN 50363-10-2)
Color	Grey, Orange or Black Other colors on request

MAIN CHARACTERISTICS

Construction	Based on EN 50525-2-21, VDE 0285, VDE 0250
General Requirements	EN 50525-1
Guide to Use	EN 50565-1/2
Electrical Tests	EN 50395
Non-electrical Tests	EN 50396
Conductor Resistance	IEC 60228, VDE 0295, BS 6360
Oil Resistant	IEC 60811-404, VDE 0473-811-404

OPERATING CHARACTERISTICS

Rated Voltage	300 /500 V (U ₀ /U)
AC Test Voltage	2 kV
Operating Temperature	
<i>In Flexing Use</i>	-40°C to +90°C
<i>In Fixed Use</i>	-50°C to +90°C
Conductor Short-Circuit Temp.	250°C (Max. 5 sec.)
Min. Installation Temp.	-40°C
Min. Bending Radius	
<i>Flexible Use</i>	10 x Outer Diameter
<i>Fixed Installation</i>	4 x Outer Diameter
Current Carrying Capacities	Based on VDE 0298-4 Tab.11 and Tab.13

APPLICATIONS

These polyurethane sheathed cables are used in mobile equipments, machines, production lines, industrial machinery and movable appliances which work under high mechanical stress. This cable is also very suitable for oily wet wet areas within production lines and agricultural equipments and machineries. Thanks to it's characteristics they have high resistance to abrasion and tear.



Cross Section (mm ²)	Nominal Overall Diameter (mm)	Approximate Weight (kg / km)	Min.Bending Radius (fixed installation) (mm)	Max. Resistance of Conductors at 20°C (ohm / km)
2x0,50	5,60	38	22	39,00
2x0,75	6,00	47	24	26,00
2x1	6,40	55	26	19,50
2x1,5	7,00	70	28	13,30
2x2,5	8,40	103	34	7,98
2x4	9,40	145	38	4,95
2x6	11,00	200	44	3,30
3x0,50	5,90	45	24	39,00
3x0,75	6,40	57	26	26,00
3x1	6,80	67	27	19,50
3x1,5	7,40	85	30	13,30
3x2,5	8,90	130	36	7,98
3x4	10,00	181	40	4,95
3x6	11,70	256	47	3,30
4x0,50	6,40	55	26	39,00
4x0,75	6,80	67	27	26,00
4x1	7,30	78	29	19,50
4x1,5	8,30	110	33	13,30
4x2,5	9,70	160	39	7,98
4x4	11,10	231	44	4,95
4x6	12,80	322	51	3,30
5x0,50	6,90	65	28	39,00
5x0,75	7,40	82	30	26,00
5x1	8,00	96	32	19,50
5x1,5	9,00	131	36	13,30
5x2,5	10,60	195	42	7,98
5x4	12,20	285	49	4,95
5x6	14,30	405	57	3,30
7x0,50	7,30	77	29	39,00
7x0,75	7,90	100	32	26,00
7x1	8,70	120	35	19,50
7x1,5	9,60	161	38	13,30
7x2,5	11,60	250	46	7,98
12x0,50	9,50	130	38	39,00
12x0,75	10,40	170	42	26,00
12x1	11,40	206	46	19,50

Cross Section (mm ²)	Nominal Overall Diameter (mm)	Approximate Weight (kg / km)	Min.Bending Radius (fixed installation) (mm)	Max. Resistance of Conductors at 20°C (ohm / km)
12x1,5	12,60	280	50	13,30
12x2,5	15,30	430	61	7,98
18x0,50	11,10	185	44	39,00
18x0,75	12,10	240	48	26,00
18x1	13,10	290	52	19,50
18x1,5	14,80	396	59	13,30
18x2,5	18,00	620	72	7,98
21x0,50	11,70	210	47	39,00
21x0,75	12,80	275	51	26,00
21x1	14,00	331	56	19,50
21x1,5	15,60	450	62	13,30
21x2,5	19,20	710	77	7,98
25x0,50	13,10	255	52	39,00
25x0,75	14,60	345	58	26,00
25x1	15,80	411	63	19,50
25x1,5	17,80	565	71	13,30
25x2,5	21,90	885	88	7,98
27x0,50	13,10	261	52	39,00
27x0,75	14,60	355	58	26,00
27x1	15,80	430	63	19,50
27x1,5	17,80	581	71	13,30
27x2,5	21,90	920	88	7,98
32x0,50	14,20	310	57	39,00
32x0,75	15,60	410	62	26,00
32x1	17,10	506	68	19,50
32x1,5	19,30	686	77	13,30
32x2,5	23,50	1071	94	7,98
36x0,50	14,70	335	59	39,00
36x0,75	16,10	445	64	26,00
36x1	17,70	555	71	19,50
36x1,5	20,00	755	80	13,30
36x2,5	24,60	1190	98	7,98





CABLE STRUCTURE

Conductor	Electrolytic annealed, class 5 stranded plain copper wires (tinned conductor on request)
Insulation	Special thermoplastic polyester elastomer, TPE-E Black cores number coded with a green-yellow core
Seperator	Polyester tape or textile tape
Screen	Tinned copper wire braiding
Outer Sheath	Thermoplastic polyurethane TMPU (EN 50363-10-2)
Color	Grey, Orange or Black Other colors on request

MAIN CHARACTERISTICS

Construction	Based on EN 50525-2-21, VDE 0285, VDE 0250
General Requirements	EN 50525-1
Guide to Use	EN 50565-1/2
Electrical Tests	EN 50395
Non - electrical Tests	EN 50396
Conductor Resistance	IEC 60228, VDE 0295, BS 6360
Oil Resistant	IEC 60811-404, VDE 0473-811-404

OPERATING CHARACTERISTICS

Rated Voltage	300 /500 V (U0/U)
AC Test Voltage	2 kV
Operating Tempetature	
<i>In Flexing Use</i>	-5°C to +70°C
<i>In Fixed Use</i>	-50°C to +90°C
Conductor Short-Circuit Temp.	250°C
Min. Installation Temp.	-40°C
Min. Bending Radius	
<i>Flexible Use</i>	12,5 x Outer Diameter
<i>Fixed Installation</i>	5 x Outer Diameter
Current Carrying Capacities	Based on VDE 0298-4 Tab.11 and Tab.13

APPLICATIONS

These polyurethane sheathed cables are used in electrical tools, mobile equipments, machines, production lines, industrial machinery and movable appliances which work under normal mechanical stress. This cable is also very suitable for oily wet wet areas within production lines and agricultural equipments and machineries. Thanks to it's characteristics they have high resistance to abrasion and tear.



Cross Section (mm ²)	Nominal Overall Diameter (mm)	Approximate Weight (kg / km)	Min.Bending Radius (fixed installation) (mm)	Max. Resistance of Conductors at 20°C (ohm / km)
2x0,50	6,50	47	33	39,00
2x0,75	6,70	55	34	26,00
2x1	7,10	62	36	19,50
2x1,5	7,90	77	40	13,30
2x2,5	9,30	107	47	7,98
2x4	10,30	143	52	4,95
2x6	11,90	195	60	3,30
3x0,50	6,80	56	34	39,00
3x0,75	7,10	66	36	26,00
3x1	7,50	76	38	19,50
3x1,5	8,50	100	43	13,30
3x2,5	9,80	136	49	7,98
3x4	11,10	190	56	4,95
3x6	12,60	260	63	3,30
4x0,50	7,30	66	37	39,00
4x0,75	7,50	78	38	26,00
4x1	8,00	91	40	19,50
4x1,5	9,20	120	46	13,30
4x2,5	10,60	170	53	7,98
4x4	12,00	240	60	4,95
4x6	14,00	340	70	3,30
5x0,50	7,80	77	39	39,00
5x0,75	8,30	100	42	26,00
5x1	8,90	115	45	19,50
5x1,5	9,90	145	50	13,30
5x2,5	11,70	210	59	7,98
5x4	13,10	295	66	4,95
5x6	15,30	420	77	3,30
7x0,50	8,40	95	42	39,00
7x0,75	8,80	116	44	26,00
7x1	9,40	137	47	19,50
7x1,5	10,50	176	53	13,30
7x2,5	12,50	261	63	7,98
12x0,50	10,40	140	52	39,00
12x0,75	11,30	185	57	26,00
12x1	12,10	216	61	19,50

Cross Section (mm ²)	Nominal Overall Diameter (mm)	Approximate Weight (kg / km)	Min.Bending Radius (fixed installation) (mm)	Max. Resistance of Conductors at 20°C (ohm / km)
12x1,5	13,80	295	69	13,30
12x2,5	16,50	440	83	7,98
18x0,50	12,00	196	60	39,00
18x0,75	12,80	251	64	26,00
18x1	14,10	316	71	19,50
18x1,5	15,80	415	79	13,30
18x2,5	19,40	655	97	7,98
21x0,50	12,60	216	63	39,00
21x0,75	13,80	295	69	26,00
21x1	14,80	351	74	19,50
21x1,5	16,80	470	84	13,30
21x2,5	20,40	731	102	7,98
25x0,50	14,30	270	72	39,00
25x0,75	15,40	350	77	26,00
25x1	16,80	425	84	19,50
25x1,5	18,80	556	94	13,30
25x2,5	23,10	880	116	7,98
27x0,50	14,30	280	72	39,00
27x0,75	15,40	360	77	26,00
27x1	16,80	441	84	19,50
27x1,5	18,80	581	94	13,30
27x2,5	23,10	920	116	7,98
32x0,50	15,20	321	76	39,00
32x0,75	16,60	422	83	26,00
32x1	17,90	510	90	19,50
32x1,5	20,50	705	103	13,30
32x2,5	24,90	1080	125	7,98
36x0,50	15,70	351	79	39,00
36x0,75	17,10	465	86	26,00
36x1	18,50	562	93	19,50
36x1,5	21,20	780	106	13,30
36x2,5	25,80	1200	129	7,98





CABLE STRUCTURE

Conductor	Electrolytic annealed, class 5 stranded plain copper wires (tinned conductor on request)
Insulation	Polyethylen compound (EN 50290-2-23)
Screen	Al-Pes Tape (%100 covered)
Screen	Tinned copper wire braiding
Sheath	PVC compound, TM2 type (EN 50363-4-1)
Color	Transparent (Black, 2YSLCYK-J version available on request)

MAIN CHARACTERISTICS

Construction	Based on IEC 60502-1
General Requirements	VDE 0250-1
Guide to Use	VDE 0276-603, HD 603 S1
Electrical Tests	EN 50395
Non - electrical Tests	EN 50396
Conductor Resistance	IEC 60228, VDE 0295, BS 6360
Flame Retardant	IEC 60332-1-2

OPERATING CHARACTERISTICS

Rated Voltage	600 / 1000 V (U ₀ /U)
AC Test Voltage	4 kV
Working Temperature	-30°C to +70°C
Conductor Short-Circuit Temp.	160°C (Max. 5 sec)
Min. Installation Temp.	-5 °C
Min. Bending Radius	VDE 276-603, HD 603 S1 Part 4
Current Carrying Capacities	IEC 60364-5-52 Tab.B12

APPLICATIONS

These cables are used as motor power supply cables with frequency converters where there is electromagnetic interference exist. Generally used in industries like automotive, air conditioning, packing, chemical and food. They can be used in dry, wet, oily and damp places inside under medium mechanical stress.



Cross Section (mm ²)	Nominal Overall Diameter (mm)	Approximate Weight (kg / km)	Min.Bending Radius (fixed installation) (mm)	Max. Resistance of Conductors at 20°C (ohm / km)
4x1,5	10,60	155	106	13,30
4x2,5	12,00	212	120	7,98
4x4	13,20	282	132	4,95
4x6	14,60	367	146	3,30
4x10	17,50	556	175	1,91
4x16	20,30	842	203	1,21
4x25	25,80	1313	258	0,780
4x35	28,30	1700	283	0,554
4x50	32,90	2337	329	0,386
4x70	38,70	3365	387	0,272
4x95	42,80	4255	428	0,206
4x120	47,80	5320	478	0,161
4x150	52,60	6385	526	0,129
4x185	58,50	7960	585	0,106
3x2,5+3x0,50	14,80	290	148	7,98
3x4+3x0,75	13,20	295	132	4,95
3x6+3x1	18,30	460	183	3,30
3x10+3x1,5	18,50	565	185	1,91
3x16+3x2,5	21,50	825	215	1,21
3x25+3x4	23,70	1100	237	0,780
3x35+3x6	26,00	1470	260	0,554
3x50+3x10	30,10	2055	301	0,386
3x70+3x10	34,70	2740	347	0,272
3x95+3x16	38,70	3530	387	0,206
3x120+3x16	43,00	4416	430	0,161
3x150+3x25	47,20	5560	472	0,129
3x185+3x35	52,60	6832	526	0,106
3x240+3x50	59,80	9100	598	0,0801



CABLE STRUCTURE

Conductor	Electrolytic annealed, class 5 stranded plain copper wires (tinned conductor on request)
Insulation	XLPE compound (Cross-linked polyethylene), 2XII type (VDE 0276-604, IEC 60502-1)
Screen	Al-Pes Tape (%100 covered)
Screen	Tinned copper wire braiding
Sheath	Halogen-Free compound, TM7 type (EN 50363-8)
Color	Black, Grey or Orange

MAIN CHARACTERISTICS

Construction	Based on IEC 60502-1
General Requirements	VDE 0250-1
Guide to Use	VDE 0276-604, HD 604
Electrical Tests	EN 50395
Non - electrical Tests	EN 50396
Conductor Resistance	IEC 60228, VDE 0295, BS 6360
Flame Retardant	IEC 60332-1-2, IEC 60332-3-24 Cat C
Halogen Content	IEC 60754-1/2
Smoke Density	IEC 61034-1/2

OPERATING CHARACTERISTICS

Rated Voltage	600 / 1000 V (U ₀ /U)
AC Test Voltage	4 kV
Working Temperature	-30°C to +90°C
Conductor Short-Circuit Temp.	250°C (Max. 5 sec)
Min. Installation Temp.	-5 °C
Min. Bending Radius	VDE 276-604, HD 604 S1 Part 4
Current Carrying Capacities	IEC 60364-5-52 Tab.B12

APPLICATIONS

These cables are used as motor power supply cables with frequency converters where there is electromagnetic interference exist. Generally used in industries like automotive, air conditioning, packing, chemical and food. They can be used in dry, wet, oily and damp places inside under medium mechanical stress. Thanks to its characteristic it's flame retardant and halogen free, available to use in areas when higher safety required in case of fire.



Cross Section (mm ²)	Nominal Overall Diameter (mm)	Approximate Weight (kg / km)	Min.Bending Radius (fixed installation) (mm)	Max. Resistance of Conductors at 20°C (ohm / km)
4x1,5	10,60	160	106	13,30
4x2,5	12,00	225	120	7,98
4x4	13,20	290	132	4,95
4x6	14,60	380	146	3,30
4x10	17,50	592	175	1,91
4x16	20,30	866	203	1,21
4x25	25,80	1315	258	0,780
4x35	28,30	1750	283	0,554
4x50	32,90	2380	329	0,386
4x70	38,70	3432	387	0,272
4x95	42,80	4315	428	0,206
4x120	47,80	5441	478	0,161
4x150	52,60	6675	526	0,129
4x185	58,50	8065	585	0,106
3x2,5+3x0,50	14,80	306	148	7,98
3x4+3x0,75	13,20	310	132	4,95
3x6+3x1	18,30	480	183	3,30
3x10+3x1,5	18,50	585	185	1,91
3x16+3x2,5	21,50	848	215	1,21
3x25+3x4	23,70	1130	237	0,780
3x35+3x6	26,00	1500	260	0,554
3x50+3x10	30,10	2095	301	0,386
3x70+3x10	34,70	2785	347	0,272
3x95+3x16	38,70	3588	387	0,206
3x120+3x16	43,00	4485	430	0,161
3x150+3x25	47,20	5641	472	0,129
3x185+3x35	52,60	6930	526	0,106
3x240+3x50	59,80	9220	598	0,0801



CABLE STRUCTURE

Conductor	Electrolytic annealed, class 5 stranded plain copper wires (tinned conductor on request)
Insulation	PVC compound, Type TII (EN 50363-3)
Color	All colors available

MAIN CHARACTERISTICS

Construction	EN 50525-2-31, IEC 60227-3
General Requirements	EN 50525-1, HD 21.9 S2, EN 50575
Guide to Use	EN 50565-1/2
Electrical Tests	EN 50395
Non - electrical Tests	EN 50396
Conductor Resistance	IEC 60228, VDE 0295
Flame Retardant	IEC 60332-1-2

OPERATING CHARACTERISTICS

Rated Voltage	H05V-K 300/500V H07V-K 450/750 V (U_0/U)
AC Test Voltage	2 kV
Working Temperature (Without mechanical shocks)	-30°C to +70°C
Conductor Short-Circuit Temp.	160°C (Maximum allowable time 5 sec)
Min. Installation Temp.	5°C
Min. Bending Radius	EN 50565-1 Tab. 3
Current Carrying Capacities	VDE 0298-4 Tab. 3 & Tab. 11 IEC 60364-5-52 Tab. B52.2 & B52.4 & B52.10

APPLICATIONS

They are used as installation cables in various electronic equipments and in switchboards. They can be used on and under plaster or must be laid in pipes.



FLAME RETARDANT

H05V-K

Cross Section (mm ²)	Nominal Overall Diameter (mm)	Approximate Weight (kg / km)	Min.Bending Radius (fixed installation) (mm)	Max. Resistance of Conductors at 20°C (ohm / km)
1x0,50	2,10	9	8	39,00
1x0,75	2,30	12	9	26,00
1x1	2,50	14	10	19,50

H07V-K

Cross Section (mm ²)	Nominal Overall Diameter (mm)	Approximate Weight (kg / km)	Min.Bending Radius (fixed installation) (mm)	Max. Resistance of Conductors at 20°C (ohm / km)
1x1,5	2,90	19	12	13,30
1x2,5	3,55	30	14	7,98
1x4	4,05	46	16	4,95
1x6	4,60	63	18	3,30
1x10	6,10	108	24	1,91
1x16	7,10	161	28	1,21
1x25	9,20	250	46	0,780
1x35	10,10	339	51	0,554
1x50	12,00	475	60	0,386
1x70	13,90	678	83	0,272
1x95	15,90	885	95	0,206
1x120	17,60	1118	106	0,161
1x150	19,40	1390	116	0,129
1x185	21,70	1692	130	0,106
1x240	25,00	2280	150	0,0801
1x300	27,80	2819	167	0,0641



CABLE STRUCTURE

Conductor	Electrolytic annealed, class 5 stranded plain copper wires (tinned conductor on request)
Insulation	Halogen-Free compound, T17 type (EN 50363-7)
Color	All colors available

MAIN CHARACTERISTICS

Construction	EN 50525-3-31
General Requirements	EN 50525-1, EN 50575
Guide to Use	EN 50565-1/2
Electrical Tests	EN 50395
Non - electrical Tests	EN 50396
Conductor Resistance	IEC 60228, VDE 0295, BS 6360
Flame Retardant	IEC 60332-1-2, IEC 60332-3-24 Cat C
Halogen Content	IEC 60754-1/2
Smoke Density	IEC 61034-1/2

OPERATING CHARACTERISTICS

Rated Voltage	H05Z1-K - 300/500V H07Z1-K 450/750 V
AC Test Voltage	2,5 kV
Operating Temperature	-30°C to +70°C
Conductor Short-Circuit Temp.	160°C
Min. Installation Temp.	-5°C
Min. Bending Radius	EN 50565-1 Tab. 3
Current Carrying Capacities	VDE 0298-4 Tab. 5 & Tab. 11, IEC 60364-5-52 Tab. B52.2 & B52.4 & B52.10

APPLICATIONS

They are used as installation cables in distribution boards, switchboards and various appliances in closed areas when higher safety required in case of fire. They can be used on and under plaster or must be laid in pipes.



FLAME RETARDANT



HALOGEN-FREE



LOW SMOKE

H05Z1-K

Cross Section (mm ²)	Nominal Overall Diameter (mm)	Approximate Weight (kg / km)	Min.Bending Radius (fixed installation) (mm)	Max. Resistance of Conductors at 20°C (ohm / km)
1x0,50	2,10	9	8	39,0
1x0,75	2,30	12	9	26,0
1x1	2,50	15	10	19,5

H07Z1-K

Cross Section (mm ²)	Nominal Overall Diameter (mm)	Approximate Weight (kg / km)	Min.Bending Radius (fixed installation) (mm)	Max. Resistance of Conductors at 20°C (ohm / km)
1x1,5	2,90	19	12	13,3
1x2,5	3,55	31	14	7,98
1x4	4,05	46	16	4,95
1x6	4,60	63	18	3,3
1x10	6,10	108	24	1,91
1x16	7,10	161	28	1,21
1x25	9,20	251	46	0,780
1x35	10,10	340	51	0,554
1x50	12,00	477	60	0,386
1x70	13,90	680	83	0,272
1x95	15,90	888	95	0,206
1x120	17,60	1121	106	0,161
1x150	19,40	1393	116	0,129
1x185	21,70	1696	130	0,106
1x240	25,00	2285	150	0,0801
1x300	27,80	2825	167	0,0641



CABLE STRUCTURE

Conductor	Electrolytic annealed, class 5 stranded plain copper wires (tinned conductor on request)
Insulation	XLPE compound (Cross-linked polyethylene), 2XII type (TS 13751)
Filler	Halogen-Free compound
Sheath	Halogen-Free compound, HM2 type (TS 13751)
Color	Grey

MAIN CHARACTERISTICS

Construction	TS 13751, TSE K 328
General Requirements	EN 50525-1, EN 50525-3-11
Guide to Use	EN 50565-1/2, VDE 0250-214
Electrical Tests	EN 50395
Non - electrical Tests	EN 50396
Conductor Resistance	IEC 60228, VDE 0295, BS 6360
Flame Retardant	IEC 60332-1-2, IEC 60332-3-24 Cat C
Halogen Content	IEC 60754-1/2
Smoke Density	IEC 61034-1/2

OPERATING CHARACTERISTICS

Rated Voltage	300/500 V (U ₀ /U)
AC Test Voltage	2 kV
Operating Temperature	-30°C to +90°C
Conductor Short-Circuit Temp.	250°C (Max. 5 sec)
Min. Installation Temp.	-5°C
Min. Bending Radius	Based on VDE 0298-3
Current Carrying Capacities	IEC 60364-5-52 Tab B52.1 & B52.3 & B52.5 & B52.12

APPLICATIONS

These cables are used as power cable in hotels, hospitals, shopping centers, power plants, industrial plants, electrical circuits in crowded places and in places where higher safety required in case of fire. They can be used on and under plaster and available to use in dry, damp and wet places.



Cross Section (mm ²)	Nominal Overall Diameter (mm)	Approximate Weight (kg / km)	Min.Bending Radius (free movement) (mm)	Max. Resistance of Conductors at 20°C (ohm / km)
2x0,75	7,80	84	31	26,00
2x1	8,20	92	33	19,50
2x1,5	8,40	105	34	13,30
2x2,5	9,20	138	37	7,98
2x4	10,60	187	42	4,95
2x6	11,40	240	46	3,30
2x10	14,20	386	57	1,91
3x0,75	8,20	95	33	26,00
3x1	8,60	104	34	19,50
3x1,5	8,80	121	35	13,30
3x2,5	9,60	158	38	7,98
3x4	11,20	227	45	4,95
3x6	12,40	301	50	3,30
3x10	15,00	468	60	1,91
4x0,75	8,70	109	35	26,00
4x1	9,20	125	37	19,50
4x1,5	9,50	144	38	13,30
4x2,5	10,30	189	41	7,98
4x4	12,50	297	50	4,95
4x6	13,90	388	56	3,30
4x10	16,30	584	65	1,91
5x0,75	9,30	126	37	26,00
5x1	9,90	143	40	19,50
5x1,5	10,20	169	41	13,30
5x2,5	11,10	224	44	7,98
5x4	13,80	352	55	4,95
5x6	15,10	458	60	3,30
5x10	17,80	700	71	1,91



CABLE STRUCTURE

Conductor	Electrolytic annealed, class 5 stranded plain copper wires (tinned conductor on request)
Insulation	PVC compound, PVC/A type (IEC 60502-1)
Inner Covering	Extruded PVC compound for only multicore cables
Sheath	PVC compound, ST2 type (IEC 60502-1)
Color	Black

MAIN CHARACTERISTICS

Construction	IEC 60502-1 +A1, VDE 0276
General Requirements	TS HD 603 S1, VDE 0276-603
Guide to Use	VDE 0250-1
Electrical Tests	EN 50395
Non - electrical Tests	EN 50396
Conductor Resistance	IEC 60228, VDE 0295, BS 6360
Flame Retardant	IEC 60332-1-2

OPERATING CHARACTERISTICS

Rated Voltage	600 / 1000 V (U ₀ /U)
AC Test Voltage	3,5 kV
Operating Temperature	
<i>In Flexing Use</i>	-5°C to +50°C
<i>In Fixed Use</i>	-30°C to +70°C
Conductor Short-Circuit Temp.	160°C (Max. 5 sec)
Min. Installation Temp.	-5°C
Min. Bending Radius	VDE 276-603, TS HD 604 S1 Part 3C
Current Carrying Capacities	VDE 0298-4 Tab.3 & Tab.4, IEC 60364-5-52 Tab B52.1 & B52.2 & B52.4 & B52.10

APPLICATIONS

These cables are used in power distribution, utilities, industrial plants, machinery and construction sites in cable ducts and pipes. They can be used both indoor and outdoor where mechanical stress is low and available to use underground.



Cross Section (mm ²)	Nominal Overall Diameter (mm)	Approximate Weight (kg / km)	Min.Bending Radius (fixed installation) (mm)	Max. Resistance of Conductors at 20°C (ohm / km)
1x1,5	5,90	50	47	13,30
1x2,5	6,40	65	51	7,98
1x4	7,30	90	58	4,95
1x6	7,80	110	62	3,30
1x10	8,90	160	71	1,91
1x16	9,90	216	79	1,21
1x25	12,00	320	96	0,78
1x35	12,90	415	103	0,554
1x50	14,80	563	118	0,386
1x70	16,90	786	135	0,272
1x95	19,10	1015	153	0,206
1x120	20,80	1262	166	0,161
1x150	22,80	1557	182	0,129
1x185	25,30	1890	202	0,106
1x240	28,80	2520	230	0,0801
1x300	31,80	3096	254	0,0641
1x400	36,90	4040	295	0,0486
1x500	40,00	5275	320	0,0384
1x630	43,40	6696	347	0,0287
2x1,5	11,80	195	94	13,30
2x2,5	12,70	236	102	7,98
2x4	14,60	325	117	4,95
2x6	15,60	386	125	3,30
2x10	17,80	535	142	1,91
2x16	19,80	706	158	1,21
2x25	24,00	1045	192	0,78
3x1,5	12,30	220	98	13,30
3x2,5	15,30	270	122	7,98
3x4	16,40	375	131	4,95
3x6	16,40	455	131	3,30
3x10	18,80	640	150	1,91
3x16	20,90	860	167	1,21
3x25	25,40	1270	203	0,78

Cross Section (mm ²)	Nominal Overall Diameter (mm)	Approximate Weight (kg / km)	Min.Bending Radius (fixed installation) (mm)	Max. Resistance of Conductors at 20°C (ohm / km)
3x35	27,40	1610	219	0,554
3x50	32,20	2237	258	0,386
3x70	36,50	3047	292	0,272
3x95	41,20	3921	330	0,206
3x120	45,50	4901	364	0,161
3x150	49,80	6000	398	0,129
3x185	55,30	7311	442	0,106
3x240	63,00	9691	504	0,0801
3x16+10	22,70	1020	182	1,21
3x25+16	27,70	1526	222	0,78
3x35+16	30,00	1900	240	0,554
3x50+25	35,40	2660	283	0,386
3x70+35	40,10	3616	321	0,272
3x95+50	45,70	4726	366	0,206
3x120+70	50,30	2930	402	0,161
3x150+70	55,00	7150	440	0,129
3x185+95	61,00	8740	488	0,106
3x240+120	69,40	11526	555	0,0801
3x300+150	77,00	14235	616	0,0641
4x1,5	13,20	256	106	13,30
4x2,5	14,20	315	114	7,98
4x4	16,50	445	132	4,95
4x6	17,70	550	142	3,30
4x10	20,40	780	163	1,91
4x16	22,80	1060	182	1,21
4x25	28,10	1595	225	0,78
4x35	30,30	2030	242	0,554
4x50	35,70	2831	286	0,386
4x70	40,70	4890	326	0,272
4x95	46,10	5033	369	0,206
4x120	50,60	6250	405	0,161
4x150	55,80	7722	446	0,129
4x185	61,80	9370	494	0,106

Cross Section (mm ²)	Nominal Overall Diameter (mm)	Approximate Weight (kg / km)	Min.Bending Radius (fixed installation) (mm)	Max. Resistance of Conductors at 20°C (ohm / km)
4x240	70,50	12460	564	0,0801
5x1,5	14,10	295	113	13,30
5x2,5	15,30	370	122	7,98
5x4	17,90	530	143	4,95
5x6	19,20	651	154	3,30
5x10	22,20	936	178	1,91
5x16	25,00	1291	200	1,21
5x25	31,50	2997	252	0,78
5x35	33,90	2535	271	0,554
7x1,5	14,90	345	119	13,30
7x2,5	16,30	440	130	7,98
7x4	19,10	635	153	4,95
7x6	20,60	795	165	3,30
7x10	23,90	1160	191	1,91
10x1,5	18,00	510	144	13,30
10x2,5	19,80	595	158	7,98
12x1,5	18,50	510	148	13,30
12x2,5	20,40	665	163	7,98
14x1,5	19,30	565	154	13,30
14x2,5	21,30	741	170	7,98
16x1,5	20,20	617	162	13,30
16x2,5	22,30	830	178	7,98
19x1,5	21,10	700	169	13,30
19x2,5	23,40	930	187	7,98
21x1,5	22,20	815	178	13,30
21x2,5	24,60	1085	197	7,98
24x1,5	24,20	861	194	13,30
24x2,5	26,90	1155	215	7,98
30x1,5	25,50	1007	204	13,30
30x2,5	28,60	1375	229	7,98
40x1,5	28,60	1340	229	13,30
40x2,5	32,50	1875	260	7,98



CABLE STRUCTURE

Conductor	Electrolytic annealed, class 1 solid (RE) or class 2 (RM) stranded plain copper wires
Insulation	Special fire resistant cross linked compound, type HIC
Core identification	According to DIN VDE 0293-308, HD 308 S2 or EN 50334
Inner Covering	Special flame retardant, halogen-free compound
Sheath	Halogen-free flame retardent compound, type HMTI
Color :	Orange

MAIN CHARACTERISTICS

Construction	HD604 S1 Part 5 Section H, VDE 0276-604 IEC 60502-1 +A1, VDE 0276
General Requirements	VDE 0276-603
Guide to Use	VDE 0250-1
Electrical Tests	DIN VDE 0276-604 :2008-02, HD604 S1, HD 505, HD 605
Non - electrical Tests	DIN VDE 0276-604 :2008-02, HD604 S1 Part 5 Section H
Conductor Resistance	IEC 60228, VDE 0295, BS 6360
Flame Retardant	IEC 60332-1-2, IEC 60332-3-22, DIN VDE 0276-604
Insulation Integrity FE180	IEC 60332-21 (180 min.)
System Circuit Integrity	DIN 4102-12 (30 - 90 min.)
Fire Resistance with mechanical shock (up to 20 mm Ø)	EN 50200, VDE 0482-200 (120 min.)
Halogen free	EN 50267-2-2, IEC 60754-1/2
Smoke Density	EN 61034-1/2

OPERATING CHARACTERISTICS

Rated Voltage	600 / 1000 V
AC Test Voltage	4 kV
Operating Temperature	-30°C to +90°C
Conductor Short-Circuit Temp.	250°C (Max. 5 sec.)
Min. Installation Temp.	-5°C
Min. Bending Radius (during installation)	
<i>Single Core Cable</i>	15 x Outer Diameter
<i>Multi Core Cable</i>	12 x Outer Diameter
Maximum permissible tensile stress	with cable grip for Cu: 50 N/mm ²
Current Carrying Capacities	VDE 0298-4 Tab.5 & Tab.6, IEC 60364-5-52 Tab B52.1 & B52.3, B52.5, B52.12

APPLICATIONS

These power cables with special performance for use in power stations and intended supply power to equipments which must operate in fire conditions and during fire fighting. Suitable for indoor applications, outdoor applications, protection must be provided against exposure to direct sunlight. If the cable laid directly in earth a protective conduit should have to be used.



FLAME RETARDANT



HALOGEN-FREE



LOW SMOKE



FIRE RESISTANT

Cross Section (mm²)	Nominal Overall Diameter (mm)	Approximate Weight (kg / km)	Min.Bending Radius (fixed installation) (mm)	Max. Resistance of Conductors at 20°C (ohm / km)
1x1,5	6,20	57	93	12,10
1x2,5	6,60	71	99	7,41
1x4	7,10	90	107	4,61
1x6	7,60	113	114	3,08
1x10	8,40	160	126	1,83
1x16	10,20	240	153	1,15
1x25	11,70	345	176	0,73
1x35	12,80	450	192	0,524
1x50	14,30	590	215	0,387
1x70	16,10	810	242	0,268
1x95	18,50	1090	278	0,193
1x120	19,60	1318	294	0,153
1x150	21,80	2025	327	0,124
1x185	24,00	2030	360	0,0991
1x240	27,20	2650	408	0,0754
1x300	29,60	3165	444	0,00601
2x1,5	11,00	178	132	12,10
2x2,5	11,80	215	142	7,41
2x4	12,80	275	154	4,61
2x6	13,80	340	166	3,08
2x10	15,40	460	185	1,83
2x16	19,00	710	228	1,15
2x25	22,00	1010	264	0,73
2x35	24,20	1285	290	0,524
2x50	28,00	1740	336	0,387
2x70	31,50	2350	378	0,268
2x95	36,20	3130	434	0,193
3x1,5	9,40	143	113	12,10
3x2,5	10,40	190	125	7,41
3x4	11,70	258	140	4,61
3x6	13,00	340	156	3,08
3x10	15,70	522	188	1,83

Cross Section (mm ²)	Nominal Overall Diameter (mm)	Approximate Weight (kg / km)	Min.Bending Radius (fixed installation) (mm)	Max. Resistance of Conductors at 20°C (ohm / km)
3x16	21,50	902	258	1,15
3x25	24,70	1290	296	0,73
3x35	27,30	1657	328	0,524
3x50	29,80	1664	358	0,387
3x70	33,90	2990	407	0,268
3x95	38,90	4000	467	0,193
3x120	41,50	4800	498	0,153
3x150	46,00	5980	552	0,124
3x185	50,70	7360	608	0,0991
3x240	57,60	9600	691	0,0754
3x35+16	28,30	1837	340	0,524
3x50+25	31,40	2407	377	0,387
3x70+35	35,80	3282	430	0,268
3x95+50	41,10	4450	493	0,193
3x120+70	45,40	5585	545	0,153
3x150+70	48,80	6577	586	0,124
3x185+95	54,40	8298	653	0,0991
3x240+120	60,40	10560	725	0,0754
4x1,5	10,20	172	122	12,10
4x2,5	11,20	226	134	7,41
4x4	12,60	312	151	4,61
4x6	14,50	430	174	3,08
4x10	17,40	663	209	1,83
4x16	23,80	1146	286	1,15
4x25	26,70	1594	320	0,73
4x35	29,50	2054	354	0,524
4x50	32,90	2681	395	0,387
4x70	38,10	3721	457	0,268
4x95	43,00	4984	516	0,193
4x120	47,30	6161	568	0,153
4x150	52,00	7500	624	0,124
4x185	56,50	9440	678	0,0991

Cross Section (mm ²)	Nominal Overall Diameter (mm)	Approximate Weight (kg / km)	Min.Bending Radius (fixed installation) (mm)	Max. Resistance of Conductors at 20°C (ohm / km)
4x240	64,10	12350	769	0,0754
5x1,5	11,10	205	133	12,10
5x2,5	12,40	276	149	7,41
5x4	13,90	382	167	4,61
5x6	16,00	528	192	3,08
5x10	19,20	812	230	1,83
5x16	25,70	1373	308	1,15
5x25	29,00	1928	348	0,73
5x35	32,20	2505	386	0,524
5x50	36,10	3283	433	0,387
5x70	42,30	4620	508	0,268
5x95	47,60	6164	571	0,193
5x120	52,10	7590	625	0,153
5x150	57,40	9295	689	0,124
5x185	63,70	11582	764	0,0991
5x240	70,90	14840	851	0,0754
7x1,5	12,10	248	145	12,10
7x2,5	13,50	338	162	7,41
10x1,5	15,70	410	188	12,10
12x1,5	16,10	443	193	12,10
12x2,5	18,00	605	216	12,10
19x1,5	19,10	637	229	12,10
24x1,5	22,90	892	275	12,10
30x1,5	24,20	1030	290	12,10



The background of the entire page is a complex, multi-layered wireframe structure in various shades of blue. It consists of numerous overlapping rectangular and cubic shapes, creating a sense of depth and architectural complexity. The lines are thin and semi-transparent, allowing the underlying layers to be visible. The overall effect is a futuristic, technical, and digital aesthetic.

ICONS, SYMBOLS & LOGOS

LEGEND OF ICONS AND SYMBOLS USED IN CATALOGUE



CHEMICAL RESISTANT



COLD RESISTANT



ELECTROMAGNETIC
COMPATIBILITY



ENGINE CABLE



EX PROOF



FIRE RESISTANT



FLAME RETARDANT



FLAT DESIGN



HALOGEN - FREE



HEAT RESISTANT



HIGH ABRASION
RESISTANCE



HOT PARTICULE
RESISTANT



LOW SMOKE



MECHANICAL
STRESSES RESISTANT



MEDIUM VOLTAGE
CABLE



MOISTURE RESISTANT



MUD RESISTANT



NO COROSIVITY



OIL RESISTANT



OZONE RESISTANT



RODENT RESISTANT



SOLVENT RESISTANT



SUBMERSION
100 MT (AD8)



TEAR RESISTANT



TERMITE RESISTANT



STEEL SUPPORTING
ELEMENTS



TEXTILE BRAIDING



UV RESISTANT



WATER DROP
RESISTANCE (AD2)



WATER
RESISTANT



WEATHER RESISTANT

LEGEND OF CERTIFICATE LOGOS USED IN CATALOGUE



TSE - Turkish Standards Institution



BV- Breau Veritas



HAR - Harmonised European Standards



RMRS - Russian Maritime Register of Shipping



VDE - German Testing and Certification Institute



RRR - Russian River Register



DEKRA Certification B.V. - Netherlands



LR - Llyod's Register



TÜV - Rheiland - Germany



TL - Türk Loydu



CPR - Construction Products Regulation



Gost - R



UK Conformity assessed - Great Britain



Russian Fire Safety



EAC - EuroAsian Economic Union



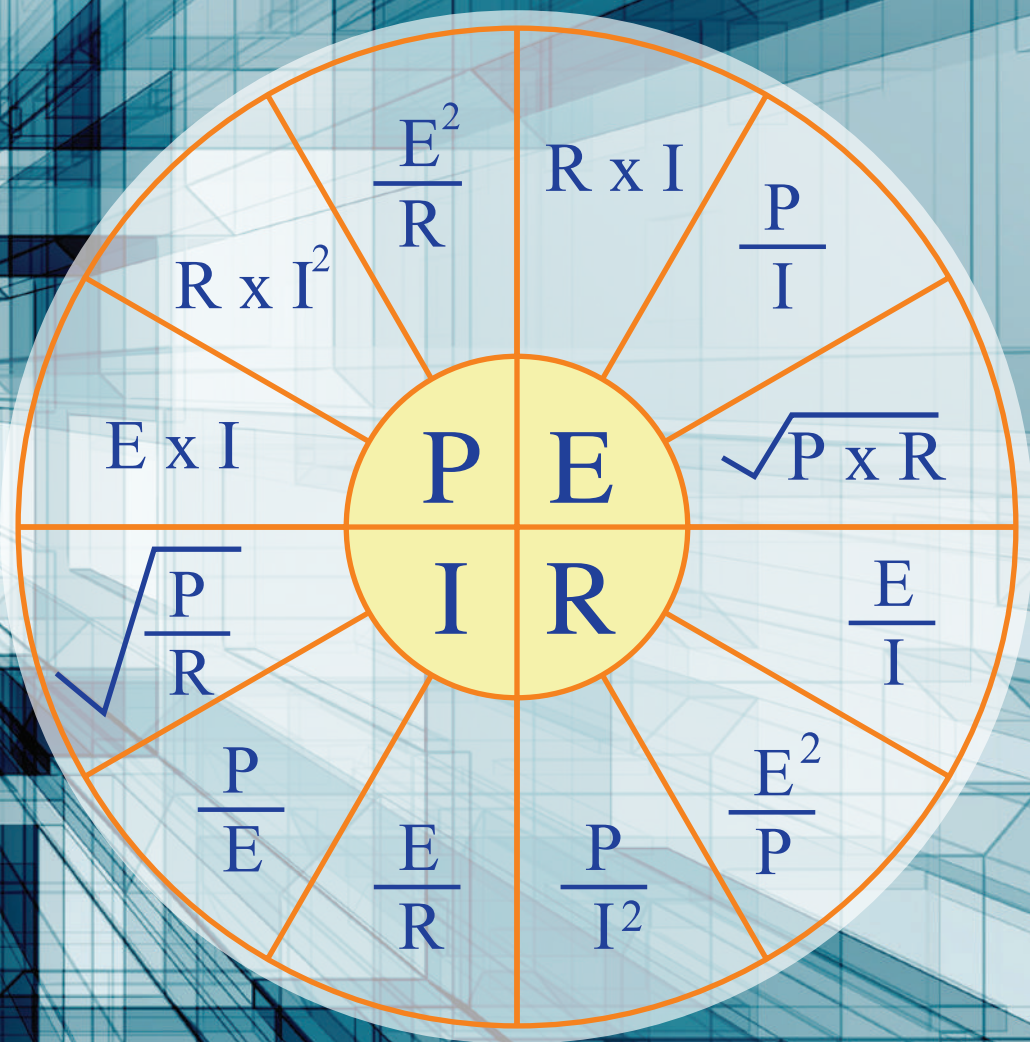

TECHNICAL DATA

TECHNICAL DATA

MAJOR INTERNATIONAL INSTITUTES & ORGANIZATIONS

Abbreviation	Name of the Organisation	Main Region of Appliance
AENOR	Asociacion Espanola de Normalizacion y Certificacion	Spain
AFNOR - CEF	Association Française de Normalisation	France
ANSI	American National Standards Institute	USA
AS	Australian Standard Australia	Australia
ASTM	American Standard of Testing Materials	USA
BASEC	British Approvals Service for Cables	United Kingdom
BSI	British Standard Institution	United Kingdom
BV	Bureau Veritas	France
CEI	Comitato Elettrotecnico Italiano	Italy
CENELEC	Comité Européen de Normalisation Electrotechniques	Europe
CNOMO	Comité de NORmalisationdes MOyens de Production	France
CSA	Canadian Standards Association	Canada
CSB TS (GB)	China State Bureau of Technical Supervision	China
DIN	Deutsches Institut für Normung	Germany
DKE	German Commission for Electrical, Electronic and Information Technologies of DIN and VDE	Germany
EAC	Eurassian Customs Union	Russi, Belarus, Kazakhstan, Armenia, Kyrgyzstan
EN	European Standards - Norms	Europe
GOST-R	Russian Standards	Russia
HD	Harmonization Documents	International
IEC	International Electrotechnical Commission	International
IEEE	Institute of Electrical and Electronics Engineers	USA
IMQ	Instituto Italiano de Marchio Qualita	Italy
ISO	International Organization for Standardization	International
JIS/JSA JIS/JSA	Japanese Standards (English Language)	Japan
KEMA	Keuring van Elektrotechnische Materialen	Netherlands
MIL	Military Specification	USA
NEC	National Electrical Code	USA
NEK	Norsk Elektroteknisk Komite	Norway
NEMA	National Electrical Manufacturers Association	USA
NEN	Nederlands Normalisatie-Instituut	Netherlands
NF	Normes Françaises	France
NZS	Standards of New Zealand	New Zealand
ÖVE	Österreichischer Verband für Elektrotechnik	Austria
SAE	Society of Automotive Engineers	USA
TSE	Turkish Standards Institution	Turkey
TUV	Technischer Überwachungs Verein	Germany
UL	Underwriters Laboratories Inc.	USA
UNE	Asociación Española de Normalización	Spain
UNI	Unificazione Nazionale Italiana	Italy
VDE	Verein Deutscher Elektrotechniker e.V.	Germany
ZVEI	ZentralVerband der Elektrotechnik- und Elektronik- Industrie e.V.	Germany

TECHNICAL DATA

CABLE DESIGNATION CODES

Harmonised Cables

(HD 361 S4 - DIN VDE 0281/0282/0292)

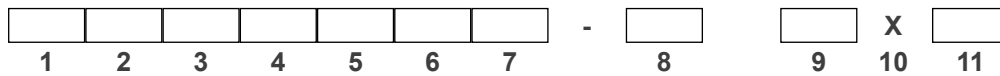

1) Relationship of cable to standards

- H Cable conforming with harmonized standards
- Non-harmonized cable

2) Rated Voltage

- 01 100/100 V
- 03 300/300 V
- 05 300/500 V
- 07 450/750 V
- 1 1000/1000 V (*)

(*) At present, the rated voltage is limited to PV-cables acc. to EN 50618.

3) Insulating and non-metallic sheathing materials

- B Ethylene- propylene rubber for conductor temperature 90 °C
- G Ethylene-vinyl-acetate
- J Glass-fibre braid
- M Mineral
- N Polychloroprene-rubber (or equivalent material)
- N2 Special-rubber compound of polychloroprene for sheathing of welding cable
- N4 Chlorosulphonated polyethylene
- N8 Special-rubber compound of polychloroprene, water resistant
- Q Polyurethane
- Q4 Polyimide
- R Ethylene- propylene or equivalent synthetic rubber for conductor temperature 60 °C
- S Silicone-rubber
- T Textile braid, impregnated or not, on assembled cores
- T6 Textile braid, impregnated or not, on individual cores of a multicore cable
- V Ordinary PVC
- V2 PVC compound for conductor temperature of 90 °C
- V3 Ordinary PVC, for low temperature operating
- V4 Ordinary PVC, crosslinked
- V5 Ordinary PVC, special oil resistant
- Z Crosslinked polyolefin-compound for cable with low smoke and non-corrosive gases in the case of fire
- Z1 Thermoplastic polyolefin-compound for cable with low smoke and non-corrosive gases in the case of fire
- Z2 Crosslinked polyolefin-compound for cable with low smoke and non-corrosive gases in the case of fire for photovoltaic cable
- Z5 Thermoplastic compound EVM-1 for cable with non-corrosive gases in the case of fire for EV charging cable
- Z6 Crosslinked compound EVM-2 for cable with non-corrosive gases in the case of fire for EV charging cable

4) Metallic coverings

- C Concentric copper conductor
- C4 Copper braid over assembled cores

5) Special constructional components of a cable

- D3 Strain-bearing element consisting of one or more components (textile or metallic), placed at the centre of a round cable or distributed inside a flat cable
- D5 Central heart (non-strain-bearing)

6) Special construction of cable

- No Symbol Round cable construction
- H Flat construction of „divisible“ cables and cores, either sheathed or non-sheathed
- H2 Flat construction of „non-divisible“ cables and cords
- H6 Flat cable having 3 or more cores, according to EN 50214
- H7 Cables with extruded double layer insulation
- H8 Coiled cable

TECHNICAL DATA

7) Conductor material

no symbol Copper
 -A Aluminium

8) Conductor form

-D Flexible conductor of welding cables (flexibility departing from EN 60228 class 5)
 -E Highly flexible conductor of welding cables (flexibility departing from EN 60228 class 6)
 -F Flexible conductor of a flexible cable or cord (flexibility according to EN 60228 class 5)
 -H Highly flexible conductor of a flexible cable or cord (flexibility according to EN 60228 class 6)
 -K Flexible conductor of a cable for fixed installations (unless otherwise specified, flexibility according to EN 60228 class 5)
 -R Rigid, round conductor, stranded
 -U Rigid, round conductor, solid
 -Y Tinsel conductor

9-10-11) Number and size of conductors

X(**) Times, where a green/yellow core is not included
 G Times, where a green/yellow core is included
 Number (*) Nominal cross-section, size of conductor in mm²
 Y For a tinsel conductor where the cross-section is not specified

(*) Countries are free to assign the symbol „N“ (placed after the conductor cross-section) to indicate that the cores are identified by numbers.

(**) Only capital letter shall be used.

Summary of symbols and their sequence in cable designation

1	2	3	4	5	6	7	8	9	10	11
Part 1		Part 2						Part 3		
Related standard	Rated voltage	Insulation material	Metallic coverings	Non-metallic sheath	Constructional components and special constructions	Conductor material	Conductor form	Number of cores	Times	Conductor cross-section mm ²
Symbols according to table(s)										
2	3	4	5	4	4 and 7	8	9	10		
H	01	B	C	B	D3 D5	No symbols: copper	- D	1 2 3 4 5 ...	X	Y
		G	C4	G	No symbol: circular construction of cable		- E		G	
	03	J	J	- A		- F	0,75			
		05	M			N, N ₂ , N ₄ , N ₈			- H	
	07		N, N ₄	Q, Q ₄			- K		1	
		1				R	H			- R
	V, V ₂ , V ₃ , V ₄		S	R					- U	2,5
		T, T ₆				S	H		- Y	
	V, V ₂ , V ₃ , V ₄ , V ₅		T, T ₆	H					10	
		Z, Z ₁ , Z ₂			Z, Z ₁ , Z ₂ , Z ₅ , Z ₆	16	25			
Z, Z ₁ , Z ₂	Z, Z ₁ , Z ₂ , Z ₅ , Z ₆		...							

TECHNICAL DATA

CABLE DESIGNATION CODES

Cables, wires and flexible cords for power installation
(VDE 0250)

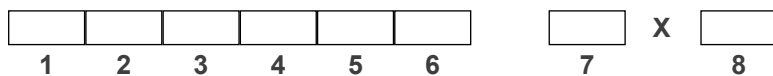

1) Relationship of cable to standards

N according to VDE
(N)/X with reference to VDE

2) Insulating materials

Y PVC
2Y Polyethylene
4Y Polyamide
5Y PTFE
6Y FEP
9Y Polypropylene
11Y Polyurethane (PUR)
X Cross-linked thermoplastics
2X XLPE
G Elastomer
2G Silicon
3G EPR-rubber
4G EVA
5G Poly-chloroprene
HX Halogen free materials

3) Cable descriptions

A Single-core non-sheathed cables
D Solid wire
AF Single-core, fine stranded
F Flexible wire for fittings
L Fluorescent tube cable
LH Connecting cable for light mechanical load
MH Connecting cable for middle mechanical Load
SH Connecting cable for heavy mechanical load
SSH Connecting cable for special mechanical load
SL Control/welding cable
S Control cable
LS Light control cable
FL Flat cable
Si Silicon cable
Z Twin cable
GL Glass fibre
Li Stranded wires as per VDE 812
LiF Stranded fine wires as per VDE 812

4) Special constructions

T Strength member – supporting element
ö Oil resistant
u Flame retardant
w Heat resistant - weather resistant
FE Insulation integrity - Fire resistant for a limited time
C Screen braided
D Screen spiral Cu wire
S Steel wire armouring

5) Sheathing materials

Y PVC
X Cross-linked thermoplastics
G Elastomer
5G Poly-chloroprene
HX Halogen free materials
11Y/ P PUR - Polyurethane

6) Protective conductor

-J with green/yellow core
-O without green/yellow core

7) Number of cores

... Number of cores

8) Conductor cross-section

... Figures in mm²

TECHNICAL DATA

CABLE DESIGNATION CODES

Italian System

(CEI 35011:2000-08)

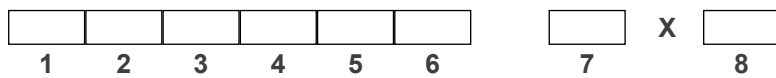

1) Type and Flexibility of conductor

- Copper conductor
- A** Aluminium conductor
- F** Stranded flexible round conductor
- EF** Stranded extra flexible round stranded or special construction
- FF** Stranded very flexible round conductor
- R** Stranded rigid conductor
- S** Sector stranded conductor
- SU** Sector single conductor
- U** Solid round conductor

2) Insulating materials

- E** Polyethylene
- E4** Cross-linked polyethylene (XLPE)
- G** Synthetic rubber compound at 60°C
- G4** Silicone rubber compound at 180°C
- G7** High module ethylene propylene rubber (HEPR)
- G8** EPR compound at 85°C also for cables without protecting covering
- G9** Cross-linked elastomeric compound with low emission of smoke and toxic and corrosive gases at 90°C, also for cables without protecting covering
- G10** Cross-linked elastomeric compound with low emission of smoke and toxic and corrosive gases at 90°C
- G16** High modulus EPR based compound with low emission of smoke and toxic and corrosive gases and acidity at 90°C for CPR cables
- G17** Cross-linked elastomeric compound with low emission of smoke, toxic & corrosive gases and acidity at 90°C, also for cables without protecting covering for CPR
- G19** Cross-linked elastomeric compound with low emission of smoke, toxic & corrosive gases at 90°C
- G20** Cross-linked elastomeric compound with low emission of smoke and toxic and corrosive gases at 90°C
- M** Mineral insulation
- M9** Thermoplastic compound with low emission of smoke, toxic and corrosive gases at 70°C
- R** TI1 and TI2 type PVC compound at 70°C,
- R2** R2 type PVC compound at 70°C,
- R4** Polyamide resin compound
- R7** TI3 type PVC compound at 90°C,
- T** Mica tape

3) Cable shape

- Single core cable
- O** Assembled cores to form a round shape cable
- D** Flat cable
- X** Cores twisted in pair, triad or quad

TECHNICAL DATA

4) Screen and concentric conductors

AC	Concentric aluminium conductor
C	Concentric Copper conductor
H	Metallised paper or aluminium tape
H1	Copper tape, copper flat strip or copper wire shield
H2	Copper braid screen
H3	Double copper braid screen
H4	Longitudinal corrugated steel tape
H5	Longitudinal laminated aluminium tape

5) Armour – Metallic Covering

A	Smooth aluminium sheath or metallic wire braiding
A1	Corrugated aluminium sheath
F	Steel wire armour
H4	Longitudinal corrugated steel tape
H5	Longitudinal laminated aluminium tape
L	Lead alloy sheath
N	Steel tape
P	Lead sheath
Q	Copper sheath
Z	Steel flat wires

6) Outer Sheath

E	Thermoplastic compound, Ez type
E4	Cross-linked polyethylene, E4M type
G	Natural and/or synthetic rubber compound, Gy type
K	Poly-Chloroprene or similar compound, Ky, Kn, Kz type
M1	LSOH Thermoplastic compound
M2	LSOH Elastomeric compound, M2 type
M3	LSOH Elastomeric compound, M3 type
M4	LSOH Elastomeric compound, M4 type
M16	Thermoplastic compound with low development of fumes and acidity (CPR)
M21	Cross-linked compound with low smoke, toxic and corrosive gas emission
R	PVC compound, TM1, TM2, RZ type
R4	Polyamide resin compound
R16	PVC-based thermoplastic compound (CPR)
T	Textile braid (impregnated if necessary)
T2	Special textile braid (impregnated if necessary)

7) Number of cores

8) Conductor cross section and type in mm²

TECHNICAL DATA

CORE COLOUR CODES ACCORDING TO HD 308 S2 / DIN VDE 0293-308

The cores of cables and cords shall be identified by the colours given in below tables. Below tables indicate the colours of the cores, according to the number of cores and the order of rotation of those colours in clockwise.

Cables and cords with a protective core

Number of cores	Colours of cores ^b				
	Protective	Live			
3	Green-and-yellow	Blue	Brown		
4	Green-and-yellow	-	Brown	Black	Grey
4 ^a	Green-and-yellow	Blue	Brown	Black	
5	Green-and-yellow	Blue	Brown	Black	Grey
6 & Up	Green - Yellow / Black Cores with White Numbers				
^a For certain applications only. ^b In this table an uninsulated concentric conductor, such as a metallic sheath, armour or screen wires, is not regarded as a core. A concentric conductor is identified by its position and, therefore, need not be identified by colour.					

Cables and cords without a protective core

Number of cores	Colours of cores ^b				
2	Blue	Brown			
3	-	Brown	Black	Grey	
3 ^a	Blue	Brown	Black		
4	Blue	Brown	Black	Grey	
5	Blue	Brown	Black	Grey	Black
6 & Up	Black Cores with White Numbers				
^a For certain applications only. ^b In this table an uninsulated concentric conductor, such as a metallic sheath, armour or screen wires, is not regarded as a core. A concentric conductor is identified by its position and, therefore, need not be identified by colour.					

TECHNICAL DATA

ÜNTEL KABLO CORE COLOUR CODES (based on GERMAN SYSTEM)

For CONTROL / SIGNAL CABLES

- JZ** Black cores with white numbers with green-yellow ground core
- OZ** Black cores with white numbers without green-yellow ground core
- JB** Coloured cores with green-yellow ground core
- OB** Coloured cores without green-yellow ground core

For POWER CABLES

- J** Coloured cores with green-yellow ground core
- O** Coloured cores without green-yellow ground core

OUTER DIAMETER TOLERANCE OF THE CABLES (*)

Nominal Outer Diameter (mm)	Tolerance (+/- mm)
1 - 10	0.5
10.1 - 20	1.0
20.1 - 30	1.5
30.1 - 40	2.0
40.1 - 50	2.5
50.1 - 60	3.0
60.1 - 70	3.5
70.1 - 80	4.0

(*) Not applicable to MV cables and sector shaped cables. For OD tolerances of these cables, refer to their own catalogue page

TECHNICAL DATA

AD PRESENCE OF WATER

According to IEC 60364-5-51 / NF C15-100

AD1	Negligible	Probability of presence of water is negligible Location in which the walls do not generally show traces of water but may do so for short periods, for example in the form of vapour which good ventilation dries rapidly IPX0	IEC 60721-3-4, class 4Z6 IEC 60529
AD2	Free-falling drops	Possibility of vertically falling drops Location in which water vapour occasionally condenses as drops or where steam may occasionally be present IPX1 or IPX2	IEC 60721-3-3, class 3Z7 IEC 60529
AD3	Sprays	Possibility of water falling as a spray at an angle up to 60° from the vertical Locations in which sprayed water forms a continuous film on floors and/or walls IPX3	IEC 60721-3-3, class 3Z8 IEC 60721-3-4, class 4Z7 IEC 60529
AD4	Splashes	Possibility of splashes from any direction Locations where equipment may be subjected to splashed water; this applies, for example, to certain external luminaires, construction site equipment IPX4	IEC 60721-3-3, class 3Z9 IEC 60721-3-4, class 4Z7 IEC 60529
AD5	Jets	Possibility of jets of water from any direction Locations where hot water is used regularly (yards, car-washing bays) IPX5	IEC 60721-3-3, class 3Z10 IEC 60721-3-4, class 4Z8 IEC 60529
AD6	Waves	Possibility of water waves Seashore locations such as piers, beaches, quays, etc. IPX6	IEC 60721-3-4, class 4Z9 IEC 60529
AD7	Immersion	Possibility of intermittent partial or total covering by water Locations which may be flooded and/or where the equipment is immersed as follows: <ul style="list-style-type: none"> • Equipment with a height of less than 850 mm is located in such a way that its lowest point is not more than 1 000 mm below the surface of the water • Equipment with a height equal to or greater than 850 mm is located in such a way that its highest point is not more than 150 mm below the surface of the water IPX7	 IEC 60529
AD8	Submersion	Possibility of permanent and total covering by water Locations such as swimming pools where electrical equipment is permanently and totally covered with water under a pressure greater than 10 kPa. IPX8	 IEC 60529

TECHNICAL DATA

WATER RESISTANCE TEST FOR AD8 CATEGORY

According to EN 50525-2-21 Annex E

Water resistance test for H07RN8-F flexible cables – Mechanical properties of sheath after water immersion

General

This test shall be carried out on samples taken from:

- a) the sheath when applied as a single layer; or
- b) the inner and outer layers of sheath when applied in two layers.

Procedure

Four sets of three dumb bell samples shall be taken from each layer of the sheath of the cable as manufactured as described in EN 60811-1-1, 9.2.3, and conditioned for seven days at a temperature of $(20 \pm 5) ^\circ\text{C}$ and a relative humidity of $(50 \pm 5) \%$. At the end of the conditioning period the sets shall be used as follows:

a) One set shall be weighed to 0,1 mg. The samples shall then be immersed in potable tap water at $(50 \pm 2) ^\circ\text{C}$ for 100 days. After removal from the potable tap water, surface water shall be removed by wiping lightly with a filter paper and the samples conditioned for 16 h at a temperature of $(20 \pm 5) ^\circ\text{C}$ and a relative humidity of $(50 \pm 5) \%$. The samples shall then be re-weighed and the weights determined to 0,1 mg as soon as possible after removal from the conditioning chamber.

b) Three sets shall be used for determination of tensile strength and elongation at break as follows:

- 1) Without immersion;
- 2) After immersion in potable tap water at $(50 \pm 2) ^\circ\text{C}$ for 28 days;
- 3) After immersion in potable tap water at $(50 \pm 2) ^\circ\text{C}$ for 100 days.

Requirements

a) Increase in mass

The increase of mass after immersion for 100 days shall not be greater than 40 % of the mass before immersion.

b) Tensile strength and elongation at break

The tensile strength and elongation at break, as described in EN 60811-1-1, 9.2.7, after immersion for 100 days shall be greater than or equal to the values given in below table.

Parameter	Units	Inner layer	Single layer / outer layer
Tensile strength	N/mm ²	5	7
Elongation at break	%	175	200

Variation between 28 days immersion and 100 days immersion:

$$-0,15 \leq \frac{TS_{28} - TS_{100}}{TS_{28}} \leq +0,15 \qquad -0,2 \leq \frac{EB_{28} - EB_{100}}{EB_{28}} \leq +0,2$$

TECHNICAL DATA

ARRANGEMENT OF THE IP CODES

According to IEC 60529

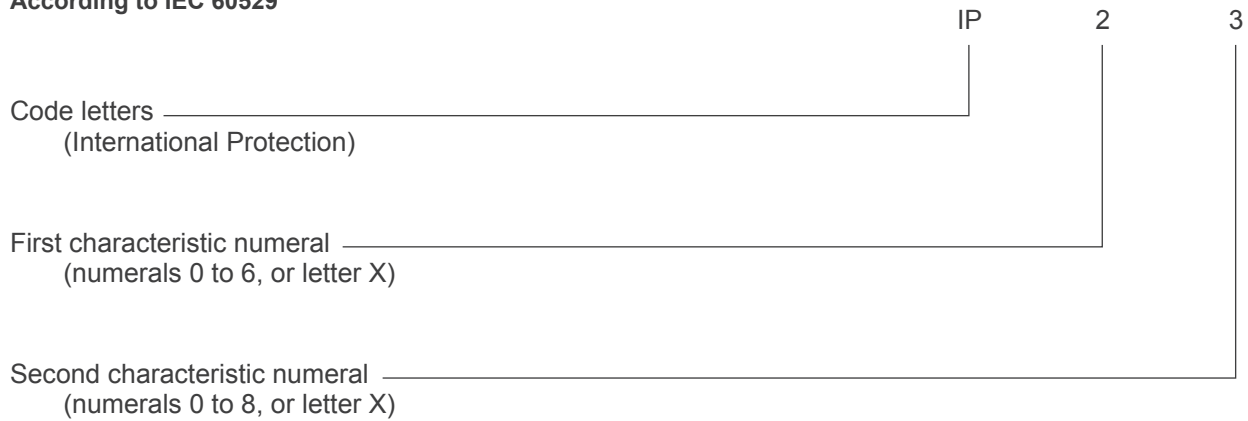

Element	Numerals or letters	Meaning for the protection of equipment	Meaning for the protection of persons
Code letters	IP	-	-
First characteristic numeral	0 1 2 3 4 5 6	Against ingress of solid foreign objects (non-protected) ≥ 50 mm diameter ≥ 12,5 mm diameter ≥ 2,5 mm diameter ≥ 1,0 mm diameter dust-protected dust-tight	Against access to hazardous parts with (non-protected) back of hand finger tool wire wire wire
Second characteristic numeral	0 1 2 3 4 5 6 7 8	Against ingress of water with harmful effects (non-protected) vertically dripping dripping (15° tilted) spraying splashing jetting powerful jetting temporary immersion continuous immersion	-

TECHNICAL DATA

MAXIMUM PULLING TENSION OF CABLES

The tension applied to a cable shall not exceed the following values of tensile stress per conductor, subject to a total maximum tensile force of 1.000 N unless otherwise agreed by the cable manufacturer.

For non-flexible cables during installation:

The maximum pulling force (P) in the main conductors shall be calculated as follows:

$$P = 50 \times S \text{ (Copper conductors)}$$

$$P = 30 \times S \text{ (Aluminium conductors)}$$

Where

P is in Newton

S is total cross-sectional area in mm² of the main conductors

(ignoring screens, concentric conductors and auxiliary conductors).

Pulling grip around the cable over sheath

$$P = 5 \times D^2$$

where

P is in Newton

D is the outer diameter of the cable in mm.

For flexible cables under static tensile stress and for non-flexible cables in service in fixed circuits:

The maximum pulling force P in the main conductors shall be calculated as follows:

$$P = 15 \times S \text{ (Copper conductors)}$$

Where

P is in Newton

S is total cross-sectional area in mm² of the main conductors (ignoring screens, concentric conductors and auxiliary conductors).

NOTE: A mass of 1 kg is approximately equal to 10 N.

TECHNICAL DATA

MINIMUM PERMISSIBLE BENDING RADIUS

The cable bending radius is the minimum radius a cable can be bent without damaging it.

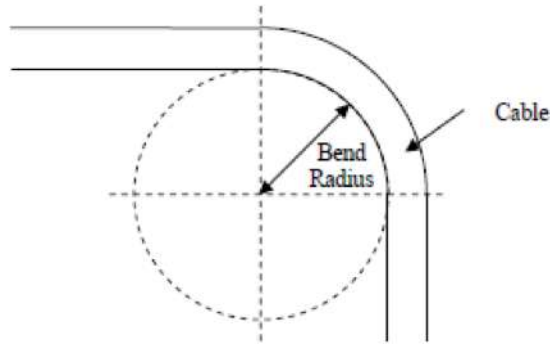

The bending radii recommended are for ambient temperatures of $(20 \pm 10) ^\circ\text{C}$.

For temperatures outside these limits, please ask for recommendations.

During the installation and/or flexing applications, the permissible bending radius of the cable shall not be smaller than the values given in this catalogue and tables

Minimum Bending Radius as per DIN VDE 0276-603, DIN VDE 0276-604

During installation

- Single core cables 15 x D (cable diameter)
- Multi core cables 12 x D (cable diameter)

Minimum Bending Radius as per HD 603-S1 Part 4 Section B

During installation

- Multi core cables 10 x D (cable diameter)

Minimum Bending Radius as per HD 603-S1 Part 3

Cable type	Bending radius	
	Class 2 conductors	Class 5 conductors
Cables without metallic screen	12 D	8 D
Cables with metallic screen	16 D	12 D

TECHNICAL DATA

MINIMUM RECOMENDED BENDING RADIUS AT CABLE TEMPERATURES OF (20± 10) °C

According to EN 50565-1 Table.3

Cable type	Minimum bending radius R (mm)			
	Cable diameter $D \geq 8$	Cable diameter $8 > D \geq 12$	Cable diameter $12 > D \geq 20$	Cable diameter $D > 20$
Cable for fixed installation				
Normal use	4D	5D	6D	6D
Carefull bending at termination (with a former)	2D	3D	4D	4D
Flexible cables (thermoplastic)				
Fixed installation	3D	3D	4D	4D
Free movement	5D	5D	6D	6D
At inlet of portable appliance or mobile equipment ^a	5D	5D	6D	6D
Under mechanical load ^b	9D	9D	9D	10D
Festooned ^c	10D	10D	11D	12D
Repeated reeling ^b	7D	7D	8D	8D
Deflected by pulleys ^b	10D	10D	10D	10D
Flexible cables (cross-linked)				
Fixed installation	3D	3D	4D	4D
Free movement	4D	4D	5D	6D
At inlet of portable appliance or mobile equipment ^a	4D	4D	5D	6D
Under mechanical load ^b	6D	6D	6D	8D
Festooned ^c	6D	6D	6D	8D
Repeated reeling ^b	6D	6D	6D	8D
Deflected by pulleys ^b	6D	8D	8D	8D
<p>D = the overall diameter of round cables or the smaller dimensions of flat cables. ^a No mechanical load on the cable ^b See 5.6.2 with regard to dynamic stress of EN 50565-1 ^c As in gantry cranes.</p>				

TECHNICAL DATA

MINIMUM PERMISSIBLE BENDING RADIUS ACC. TO DIN VDE 0298 PART3

Rated voltage	up to 0,6/1kV				above 0,6/1kV
	up to 8	above 8 up to 12	above 12 up to 20	above 20	
Outer diameter of the cable or thickness of flat cable (mm)					
Fixed installation	3 x d	3 x d	4 x d	4 x d	6 x d
Freely movable	3 x d	4 x d	5 x d	5 x d	10 x d
Cable entry/gland	3 x d	4 x d	5 x d	5 x d	10 x d
As for cable-drum mode	5 x d	5 x d	5 x d	6 x d	12 x d
Festoon mode	3 x d	4 x d	5 x d	5 x d	10 x d
Drag-chain mode	4 x d	4 x d	5 x d	5 x d	10 x d
Roller reversing	7.5 x d	7.5 x d	7.5 x d	10 x d	15 x d
Cable tenders	7.5 x d	7.5 x d	7.5 x d	7.5 x d	15 x d
Minimum distance with double or S-type directional changes	20 x d	20 x d	20 x d	20 x d	20 x d

TECHNICAL DATA

AWG - METRIC CONVERSION CHART

AWG Number	Cross section mm ²	Cross section mm ² (nearest metric size)	Conductor diameter mm
1000 MCM	507	500	29,3
900	456	-	27,8
750	380	400	25,4
600	304	300	22,7
550	279	-	21,7
500	253	240	20,7
450	228	-	19,6
400	203	-	18,5
350	177	185	17,3
300	152	150	16,0
250	127	-	14,6
4/0	107,2	120	11,68
3/0	85	95	10,4
2/0	67,4	70	9,27
0	53,4	-	8,25
1	42,4	50	7,35
2	33,6	35	6,54
3	26,7	-	5,83
4	21,2	25	5,19
5	16,8	-	4,62
6	13,3	16	4,11
7	10,6	-	3,67
8	8,34	10	3,26
9	6,62	-	2,91
10	5,26	6	2,59
11	4,15	-	2,30
12	3,31	4	2,05
13	2,63	-	1,83
14	2,08	2,5	1,63
15	1,65	-	1,45
16	1,31	1,5	1,29
17	1,04	-	1,15
18	0,823	1	1,024
19	0,653	0,75	0,912
20	0,519	0,5	0,812
21	0,412	-	0,723
22	0,324	0,34	0,644
23	0,259	-	0,573
24	0,205	0,25	0,511
25	0,163	-	0,455
26	0,128	0,14	0,405

1 mil = inch = 0.0254 mm 1 CM = 1 Circ. mil = 0.0005067 mm² 1 MCM = 1000 Circ. mils = 0.5067 mm²

TECHNICAL DATA

GENERAL CONDUCTOR STRANDING

According to DIN VDE 0295 / IEC 60228

	Ordinary Stranding	multi wire strands	fine strands	super fine strands
Class	2		5	6
cross-section mm ²	number of single wires x wire \varnothing mm			
0,50	7 x 0,30	7 x 0,30	16 x 0,20	28 x 0,15
0,75	7 x 0,37	7 x 0,37	24 x 0,20	42 x 0,15
1,0	7 x 0,43	7 x 0,43	32 x 0,20	56 x 0,15
1,5	7 x 0,52	7 x 0,52	30 x 0,25	84 x 0,15
2,5	7 x 0,67	19 x 0,41	50 x 0,25	140 x 0,15
4	7 x 0,85	19 x 0,52	56 x 0,30	224 x 0,15
6	7 x 1,05	19 x 0,64	84 x 0,30	192 x 0,20
10	7 x 1,35	49 x 0,51	80 x 0,40	320 x 0,20
16	7 x 1,70	49 x 0,65	128 x 0,40	512 x 0,20
25	7 x 2,13	200 x 0,40	128 x 0,40	800 x 0,20
35	7 x 2,52	133 x 0,58	280 x 0,40	1.120 x 0,20
50	19 x 1,83	133 x 0,69	400 x 0,40	705 x 0,30
70	19 x 2,17	189 x 0,69	356 x 0,50	990 x 0,30
95	19 x 2,52	259 x 0,69	485 x 0,50	1.340 x 0,30
120	37 x 2,03	336 x 0,67	614 x 0,50	1.690 x 0,30
150	37 x 2,27	392 x 0,69	765 x 0,50	2.123 x 0,30
185	37 x 2,52	494 x 0,69	944 x 0,50	1.470 x 0,40
240	61 x 2,24	627 x 0,70	1.225 x 0,50	1,905 x 0,40
300	61 x 2,50	790 x 0,70	1,530 x 0,50	2,385 x 0,40
400	61 x 2,89		2.035 x 0,50	
500	61 x 3,23		1.768 x 0,60	

NOTE:

- The number of wires indicated in the column 3-7 is non binding and they are just general informations.
- The VDE 0295 only stipulates the max. diameter of the individual wires and the max. resistance allocated to the cross-section.
- From cross-section 0,5mm² onwards the listed conductor stranding is also in line with IEC 60228

Additional information is also available in IEC 60228 & DIN VDE 0295

Conductor Construction

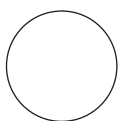

circular solid
RE

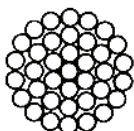

circular stranded
RM

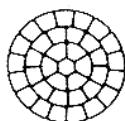

circular stranded compacted
RMV



sector-shaped solid
SE

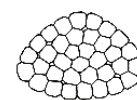

sector-shaped stranded
SM

TECHNICAL DATA

Conductor Resistance at 20 °C (IEC 60228, DIN VDE 0295)

Conductor Resistance (mm ²)	Plain Copper Conductor (Ω/km)		Tinned Copper Conductor (Ω/km)	
	Class 1&2	Class 5&6	Class 1&2	Class 5&6
0,5	36,0	39,0	36,7	40,1
0,75	24,5	26,0	24,8	26,7
1	18,1	19,5	18,2	20,0
1,5	12,1	13,3	12,2	13,7
2,5	7,41	7,98	7,56	8,21
4	4,61	4,95	4,70	5,09
6	3,08	3,30	3,11	3,39
10	1,83	1,91	1,84	1,95
16	1,15	1,21	1,16	1,24
25	0,727	0,780	0,734	0,795
35	0,524	0,554	0,529	0,565
50	0,387	0,386	0,391	0,393
70	0,268	0,272	0,270	0,277
95	0,193	0,206	0,195	0,210
120	0,153	0,161	0,154	0,164
150	0,124	0,129	0,126	0,132
185	0,0991 (*)	0,106	0,100	0,108
240	0,0754 (*)	0,0801	0,0762	0,0817
300	0,0601 (*)	0,0641	0,0607	0,0654
400	0,0470 (*)	0,0486	0,0475	0,0495
500	0,0366 (*)	0,0384	0,0369	0,0391
630	0,0283 (*)	0,0287	0,0286	0,0292

Class 1: Single core conductor

Class 2: Stranded conductor

Class 5: Fine wire conductors

Class 6: Extra fine wire conductors

Formula for temperature correction factors to correct measured values to R 20°C

$$k_{t,Cu} = \frac{254,5}{234,5 + t} = \frac{1}{1 + 0,00393(t-20)}$$

where t is the temperature of measurement

(*) Values are for Class 2 conductors

TECHNICAL DATA

CURRENT CARRYING CAPACITIES

Recommended values according to DIN VDE 0298-4 / Table.11

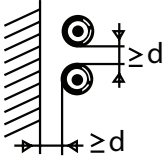
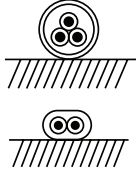
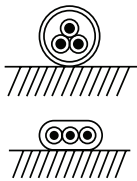
Installation	Free in air		on or around surface	
	Single core - rubber insulated - PVC insulated - heat resistant 	Multi core cables for household or handheld devices - rubber insulated - PVC insulated 	Multi core cables (not for household or handheld devices) - rubber insulated - PVC insulated - heat resistant 	
Number of loaded cores	1	2	3	2 or 3
Cross section (mm ²)	Current carrying capacity (A)			
0,5	-	3	3	-
0,75	15	6	6	12
1	19	10	10	15
1,5	24	16	16	18
2,5	32	25	20	26
4	42	32	25	34
6	54	40	-	44
10	73	63	-	61
16	98	-	-	82
25	129	-	-	108
35	158	-	-	135
50	198	-	-	168
70	245	-	-	207
95	292	-	-	250
120	344	-	-	292
150	391	-	-	335
185	448	-	-	382
240	528	-	-	453
300	608	-	-	523
400	726	-	-	-
500	830	-	-	-
Correction factors for				
Deviating ambient temperatures	Table 10, 17 ^(*)	-	-	Table 10, 17 ^(*)
Accumulation / Grouping	Table 10 ^(*)	-	-	Table 21 ^(*)
Laying under the ceiling	-	-	-	Table 21 ^(*)
Multi core cables	-	-	-	Table 26 ^(*)

(*) Tables in VDE 0298 Part 4

TECHNICAL DATA

CURRENT CARRYING CAPACITIES

Recommended values according to DIN VDE 0298-4 / Table.13

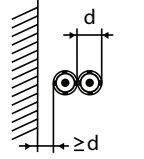
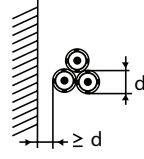
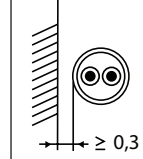
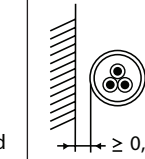
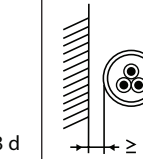
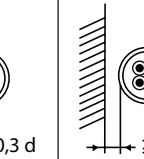
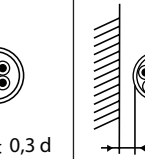
Permissible operating temperature at the conductor	60 °C						
Ambient temperature	30 °C						
Installation Free in air							
Number of loaded cores	2	3	2	2	3	3	3
Cross section (mm ²)	Current carrying capacity (A)						
1	-	-	15,0	15,5	12,5	13,0	13,5
1,5	19,0	16,5	18,5	19,5	15,5	16,0	16,5
2,5	26	22	25	26	21	22	23
4	34	30	34	35	29	30	30
6	43	38	43	44	36	37	38
10	60	53	60	62	51	52	54
16	79	71	79	82	67	69	71
25	104	94	105	109	89	92	94
35	129	117	129	135	110	114	117
50	162	148	162	169	138	143	148
70	202	185	202	211	172	178	185
95	240	222	240	250	204	210	222
120	280	260	-	292	238	246	-
150	321	300	-	335	273	282	-
185	363	341	-	378	309	319	-
240	433	407	-	447	365	377	-
300	497	468	-	509	415	430	-
400	586	553	-	-	-	-	-
500	670	634	-	-	-	-	-
630	784	742	-	-	-	-	-
Correction factors for							
Deviating ambient temperatures	Table 17 ^(*)						
Accumulation / Grouping	-	Table 23 ^(*)	Table 22 ^(*)				
Spoiled - coiled wound cables	-		Table 22 ^(*)				
Multi core cables	-				Table 26 ^(*)	-	

(*) Tables in VDE 0298 Part 4

TECHNICAL DATA

CURRENT CARRYING CAPACITIES

Recommended values according to VDE 0298-4 / Table.15

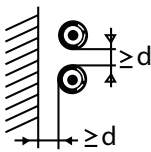
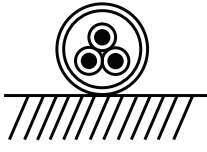
Rated temperature at the conductor	90 °C		-	
Recommended operating temperature	-		80 °C	
Ambient temperature	30 °C			
Installation type	free in air		on or around surface	
	Special rubber insulated single core cables 		Multi core rubber cables and trailing cables 	
Nominal Voltage	0,6/1 kV and 1,8/3 kV	3,6/6 kV and	6/1 kV up to	6/10 kV above
Number of loaded cores	1	1	3	3
Cross section (mm ²)	Current carrying capacity (A)			
1,5	30	32	-	-
2,5	41	43	30	-
4	55	56	41	-
6	70	71	53	-
10	98	99	74	-
16	132	133	99	105
35	218	215	162	172
50	276	270	202	216
70	347	338	250	265
95	416	403	301	319
120	488	473	352	371
150	566	546	404	428
185	644	622	461	488
240	775	-	-	-
300	898	-	-	-
Correction factors for				
Deviating ambient temperatures	Table 17 ^(*) , column 7		Table 17 ^(*) , column 5	
Accumulation / Grouping	Table 14 ^(*)		Table 21 ^(*)	
For reeling applications	-		Table 27 ^(*)	
Multi core cables	-		Table 26 ^(*)	-

(*) Tables in VDE 0298 Part 4

PS: For reeling applications details use the current rating tables in our Crane Catalogue at our web page.

TECHNICAL DATA

CURRENT CARRYING CAPACITIES

The correction factor for deviating ambient temperatures of 30 °C according to DIN VDE 0298 Part 4 Table 17

Insulation material	Rubber	PVC	XLPE / HEPR
Max. permissible operating temperature at conductor	60 °C	70 °C	90 °C
Ambient temperature °C	Correction factor		
10	1,29	1,22	1,15
15	1,22	1,17	1,12
20	1,15	1,12	1,08
25	1,08	1,06	1,04
30	1,00	1,00	1,00
35	0,91	0,94	0,96
40	0,82	0,87	0,91
45	0,71	0,79	0,87
50	0,58	0,71	0,82
55	0,41	0,61	0,76
60	-	0,5	0,71
65	-	0,35	0,65
70	-	-	0,58
75	-	-	0,50
80	-	-	0,41
85	-	-	0,29
90	-	-	-

De-rating factor for multi core cables in acc. with DIN VDE 0298, Part 4 Table 26

No. of wires carrying current	5	7	10	14	19	24	40	61
Correction factor (*)	0,75	0,65	0,55	0,50	0,45	0,40	0,35	0,30

(*) Installed as free air

De-rating factor for the dependency of ampacity on the number of layers on reel in acc. with DIN VDE 0298 Part 4 Table 27 for cable reeling applications

No. of wires full layers on reel	1 (*)	2	3	4	5
Conversion factor (*)	0,50	0,45	0,40	0,35	0,30



(*) Also applies for spiral winding

TECHNICAL DATA

CURRENT RATINGS FOR FIXED INSTALLATION AS PER IEC 60364-5-52

Installation reference methods forming basis of tabulated current-carrying capacities according to IEC 60364-5-52 Table B.52.1

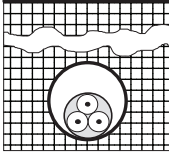
Reference method of installation

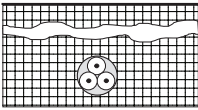
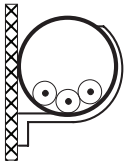
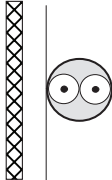
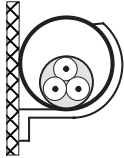
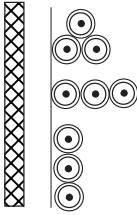
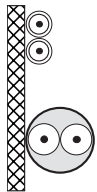
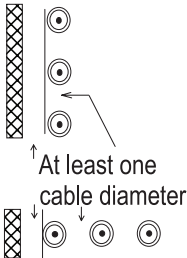









<p>A1</p> 	<p>Insulated conductors (single-core cables) in conduit in a thermally insulated wall</p>	<p>D1</p> 	<p>Multi-core cable in ducts in the ground</p>
<p>A2</p> 	<p>Multi-core cable in conduit in a thermally insulated wall</p>	<p>D2</p> 	<p>Sheathed single-core or multi-core cables direct in the ground.</p>
<p>B1</p> 	<p>Insulated conductors (single-core cables) in conduit on a wooden wall</p>	<p>E</p> 	<p>Multi-core cable in free air. Clearance to wall not less than 0,3 times cable diameter</p>
<p>B2</p> 	<p>Multi-core cable in conduit on a wooden wall</p>	<p>F</p> 	<p>Single-core cables, touching in free air. Clearance to wall not less than one cable diameter</p>
<p>C</p> 	<p>Single-core or multi-core cable on a wooden wall</p>	<p>G</p> 	<p>Single-core cables, spaced in free air</p>

TECHNICAL DATA

CURRENT RATINGS FOR FIXED INSTALLATION AS PER IEC 60364-5-52

Recommended values according to table IEC 60364-5-52 table B.52.2 and B52.4

Operating temperature at conductor 70°C (PVC insulation) ; Ambient temperature 30°C in air, 20 °C in ground

Installation methods as per Table B.52.1	A1		A2		B1		B2		C	
										
Number of loaded cores	2	3	2	3	2	3	2	3	2	3
Nominal cross- sectional area of conductor (mm ²)	Current Carrying Capacity (A)									
1,5	14,5	13,5	14	13	17,5	15,5	16,5	15	19,5	17,5
2,5	19,5	18	18,5	17,5	24	21	23	20	27	24
4	26	24	25	23	32	28	30	27	36	32
6	34	31	32	29	41	36	38	34	46	41
10	46	42	43	39	57	50	52	46	63	57
16	61	56	57	52	76	68	69	62	85	76
25	80	73	75	68	101	89	90	80	112	96
35	99	89	92	83	125	110	111	99	138	119
50	119	108	110	99	151	134	133	118	168	144
70	151	136	139	125	192	171	168	149	213	184
95	182	164	167	150	232	207	201	179	258	223
120	210	188	192	172	269	239	232	206	299	259
150	240	216	219	196	300	262	258	225	344	299
185	273	245	248	223	341	296	294	255	392	341
240	321	286	291	261	400	346	344	297	461	403
300	367	328	334	298	458	394	394	339	530	464

NOTE: In columns of A2, B2 and C installation method circular conductors are assumed for sizes up to and including 16 mm². Values for larger sizes relate to shaped conductors and may safely be applied to circular conductors.

Conversion factor for deviating ambient temperature, grouping, installation under the ceiling, multicore cables and insulated wires see DIN VDE 0298 part 4.

TECHNICAL DATA

CURRENT RATINGS FOR FIXED INSTALLATION AS PER IEC 60364-5-52

Recommended values according to table IEC 60364-5-52 table B.52.3 and B52.5

Operating temperature at conductor 90°C (XLPE / EPR insulation) ; Ambient temperature 30°C in air, 20 °C in ground

Installation methods as per Table B.52.1	A1		A2		B1		B2		C	
Number of loaded cores	2	3	2	3	2	3	2	3	2	3
Nominal cross- sectional area of conductor (mm ²)	Current Carrying Capacity (A)									
1,5	19	17	18,5	16,5	23	20	22	19,5	24	22
2,5	26	23	25	22	31	28	30	26	33	30
4	35	31	33	30	42	37	40	35	45	40
6	45	40	42	38	54	48	51	44	58	52
10	61	54	57	51	75	66	69	60	80	71
16	81	73	76	68	100	88	91	80	107	96
25	106	95	99	89	133	117	119	105	138	119
35	131	117	121	109	164	144	146	128	171	147
50	158	141	145	130	198	175	175	154	209	179
70	200	179	183	154	253	222	221	194	269	229
95	241	216	220	197	306	269	265	233	328	278
120	278	249	253	227	354	312	305	268	382	322
150	318	285	290	259	393	342	334	300	441	371
185	362	324	329	295	449	384	384	340	506	424
240	424	380	386	346	528	450	459	398	599	500
300	486	435	442	396	603	514	532	455	693	576

NOTE: In columns of A2, B2, and C installation method circular conductors are assumed for sizes up to and including 16 mm². Values for larger sizes relate to shaped conductors and may safely be applied to circular conductors.

Conversion factor for deviating ambient temperature, grouping, installation under the ceiling, multicore cables and insulated wires see DIN VDE 0298 part 4.

TECHNICAL DATA

CURRENT RATINGS FOR FIXED INSTALLATION AS PER IEC 60364-5-52

Recommended values according to table IEC 60364-5-52 table B.52.10

Operating temperature at conductor 70°C (PVC insulation) reference Ambient temperature: 30°C

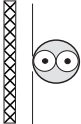
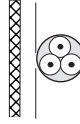
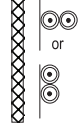
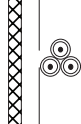
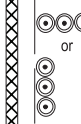
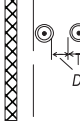
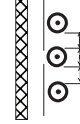
Installation methods as per Table B.52.1	Multi-core cables		Single-core cables				
	Method E		Method F		Method F	Method G	
							
Number of loaded cores	2	3	2 - touching	3 - trefoil	3 - flat touching	3 - flat spaced Horizontal	3 - flat spaced Vertical
Nominal cross-sectional area of conductor (mm ²)	Current Carrying Capacity (A)						
1,5	22	18,5	-	-	-	-	-
2,5	30	25	-	-	-	-	-
4	40	34	-	-	-	-	-
6	51	43	-	-	-	-	-
10	70	60	-	-	-	-	-
16	94	80	-	-	-	-	-
25	119	101	131	110	114	146	130
35	148	126	162	137	143	181	162
50	180	153	196	167	174	219	197
70	232	196	251	216	225	281	254
95	282	238	304	264	275	341	311
120	328	276	352	308	321	396	362
150	379	319	406	356	372	456	419
185	434	364	463	409	427	521	480
240	514	430	546	485	507	615	569
300	593	497	629	561	587	709	659
400	-	-	754	656	689	852	795
300	-	-	868	749	789	982	920
630	-	-	1005	855	905	1138	1070

NOTE 1: Circular conductors are assumed for sizes up to and including 16 mm². Values for larger sizes relate to shaped conductors and may safely be applied to circular conductors.

NOTE 2: D_e is the external diameter of the cable

TECHNICAL DATA

CURRENT RATINGS FOR FIXED INSTALLATION AS PER IEC 60364-5-52

Recommended values according to table IEC 60364-5-52 table B.52.12

Operating temperature at conductor 90°C (XLPE / EPR insulation) reference Ambient temperature: 30°C

Installation methods as per Table B.52.1	Multi-core cables		Single-core cables				
	Method E		Method F		Method F	Method G	
Number of loaded cores	2	3	2 - touching	3 - trefoil	3 - flat touching	3 - flat spaced Horizontal	3 - flat spaced Vertical
Nominal cross-sectional area of conductor (mm ²)	Current Carrying Capacity (A)						
1,5	26	23	-	-	-	-	-
2,5	36	32	-	-	-	-	-
4	49	42	-	-	-	-	-
6	63	54	-	-	-	-	-
10	86	75	-	-	-	-	-
16	115	100	-	-	-	-	-
25	149	127	161	135	141	182	161
35	185	158	200	169	176	226	201
50	225	192	242	207	216	275	246
70	289	246	310	268	279	353	318
95	352	298	377	328	342	430	389
120	410	346	437	383	400	500	454
150	473	399	504	444	464	577	527
185	542	456	575	510	533	661	605
240	641	538	679	607	634	781	719
300	741	621	783	703	736	902	833
400	-	-	940	823	868	1085	1008
300	-	-	1083	946	998	1253	1169
630	-	-	1254	1088	1151	1454	1362

NOTE 1: Circular conductors are assumed for sizes up to and including 16 mm². Values for larger sizes relate to shaped conductors and may safely be applied to circular conductors.

NOTE 2: D_e is the external diameter of the cable

TECHNICAL DATA

CURRENT RATINGS FOR FIXED INSTALLATION AS PER IEC 60364-5-52

Recommended values according to table IEC 60364-5-52 table C.52.1
Simplification of the tables

Reference methods in Table B.52.1	Number of loaded conductors and type of insulation											
		3 PVC	2 PVC		3 XLPE	2 XLPE						
A1		3 PVC	2 PVC		3 XLPE	2 XLPE						
A2	3 PVC	2 PVC		3 XLPE	2 XLPE							
B1				3 PVC	2 PVC		3 XLPE		2 XLPE			
B2			3 PVC	2 PVC		3 XLPE	2 XLPE					
C					3 PVC		3 PVC	3 XLPE		3 XLPE		
E						3 PVC		3 PVC			3 XLPE	
F							3 PVC		3 PVC	3 XLPE		3 XLPE
Size (mm ²) Copper	Current Carrying Capacity (A)											
1,5	13	13,5	14,5	15,5	17	18,5	19,5	22	23	24	26	-
2,5	17,5	18	19,5	21	23	25	27	30	31	33	36	-
4	23	24	26	28	31	34	36	40	42	45	49	-
6	29	31	34	36	40	43	46	51	54	58	63	-
10	39	42	46	50	54	60	63	70	75	80	86	-
16	52	56	61	68	73	80	85	94	100	107	115	-
25	68	73	80	89	95	101	110	119	127	135	149	161
35	-	-	-	110	117	126	137	147	158	169	185	200
50	-	-	-	134	141	153	167	179	192	207	225	242
70	-	-	-	171	179	196	213	229	246	268	289	310
95	-	-	-	207	216	238	258	278	298	328	352	377
120	-	-	-	239	249	276	299	322	346	382	410	437
150	-	-	-	-	285	318	344	371	395	441	473	504
185	-	-	-	-	324	362	392	424	450	506	542	575
240	-	-	-	-	380	424	461	500	538	599	641	679

NOTE : The appropriate table of current-carrying capacity given in Annex B of IEC 60364-5-52 should be consulted to determine the range of conductor sizes for which the above current-carrying capacities are applicable, for each installation method

TECHNICAL DATA

CURRENT RATINGS FOR FIXED INSTALLATION AS PER IEC 60364-5-52

Correction factors for ambient air temperature other than 30 °C
according to IEC 60364-5-52 table B.52.14

Ambient air temperature °C	Insulation type	
	PVC	XLPE and EPR
10	1,22	1,15
15	1,17	1,12
20	1,12	1,08
25	1,06	1,04
30	1,00	1,00
35	0,94	0,96
40	0,87	0,91
45	0,79	0,87
50	0,71	0,82
55	0,61	0,76
60	0,50	0,71
65	-	0,65
70	-	0,58
75	-	0,50
80	-	0,41

Reduction factors of different installation methods for one circuit or one multi-core cable
or for a group of more than one circuit, or more than one multi-core cable
Please refer to table IEC 60364-5-52 tables from B.52.17 to B.52.21

TECHNICAL DATA

SHORT CIRCUIT CURRENT RATINGS

The short-circuit capacity of a cable shall be such that all short-circuit current occurring at any point of a circuit shall not cause the cable conductor temperature to exceed the maximum permissible limit. During a short-circuit, the conductor temperature will increase due to the heat energy produced. The theoretical temperature that arises in the conductor during a short circuit, which is used as a basis of the calculation, is in accordance with IEC 60724.

The maximum permissible short circuit current of cables up to 1kV with copper conductors could be calculated with the following formula

$$I_{(sc)} = \frac{S}{\sqrt{t}} \times k$$

- I_{sc} = Short Circuit Current (A)
- t = Duration of Short Circuit (s)
- k = Insulation Material Specific Constant
- S = Nominal Conductor Area (mm²)

Maximum allowable short circuit current duration is 5 seconds.

k constant values for copper conductors are dependent on the temperature difference between start and end of short-circuit

Table for k constant values

Initial temperature (C ^o)	Final temperature (C ^o)					
	140	160	180	200	220	250
90	86	100	112	122	131	143
85	90	104	115	125	134	146
80	94	108	119	129	137	149
75	99	111	122	132	140	151
70	103	115	125	135	143	154
65	107	119	129	138	146	157
60	111	122	132	141	149	160
50	118	129	139	147	155	165
40	126	136	145	153	161	170
30	133	143	152	159	166	176

TECHNICAL DATA

Permissible operating temperature, short-circuit temperature and short-circuit current for cables with copper conductors

Insulation Type of Cable	Permissible operating temperature °C	Permissible short-circuit temperature °C	Conductor temperature at the beginning of short-circuit C°						
			90	80	70	60	50	40	30
			Short-circuit current for 1 sec A/mm ²						
XLPE / HEPR	90	250	143	149	154	160	165	170	176
PVC ≤ 300mm ²	70	160	-	-	115	122	129	136	143
> 300mm ²	70	140	-	-	103	111	118	126	133
EPR / Rubber	60	200	-	-	-	141	147	153	159

Short Circuit Ratings for Low Voltage Cables

Cross section (mm ²)	Short Circuit Current Carrying Capacities kA (1 Sec.)		
	PVC Initial 70 °C Final 160 °C	XLPE / HEPR Initial 90°C Final 250 °C	EPR / RUBBER Initial 60°C Final 200 °C
1	0,115	0,143	0,141
1,5	0,173	0,215	0,212
2,5	0,288	0,358	0,352
4	0,460	0,572	0,564
6	0,690	0,858	0,846
10	1,150	1,430	1,410
16	1,840	2,288	2,256
25	2,875	3,575	3,525
35	4,025	5,005	4,935
50	5,750	7,150	7,050
70	8,050	10,010	9,870
95	10,925	13,585	13,395
120	13,800	17,160	16,920
150	17,250	21,450	21,150
185	21,275	26,455	26,085
240	27,600	34,320	33,840
300	34,500	42,900	42,300
400	41,200	57,200	56,400
500	51,500	71,500	70,500
630	64,890	90,090	88,830

TECHNICAL DATA

VOLTAGE DROP

In the absence of specific design limits set by a regulatory body, the cross-sectional areas of conductors shall be so determined that when the conductors are carrying the maximum current under normal conditions of service, the drop in voltage from the main or emergency switchboard bus-bars to any and every point on the installation does not exceed the limitation given in Clause 36 of IEC 60092-201

Current carrying in cable core(s) induce(s) a voltage drop and value of this voltage drop is the difference between the measured voltages at both ends of the cable

Generally accepted values for voltage drop are 3% for lighting and 5% for motors and other applications.

Voltage drop depends on:

- Type of current (DC) or (AC)
- Single or three-phased systems.
- Length of the cable
- Carrying current capacity and power factor.
- Electrical resistance and inductance.

$$\text{Voltage drop in percent} = \frac{\text{Voltage drop in V} \times 100}{\text{Circuit voltage in V}}$$

In DC system

$$V_d = 2 \times I \times L \times R$$

In AC Single Phase System

$$V_d = 2 \times I \times L \times (R \cdot \cos \phi + X \cdot \sin \phi)$$

In AC Three Phase System

$$V_d = \sqrt{3} \times I \times L \times (R \cdot \cos \phi + X \cdot \sin \phi)$$

Where

- V_d Voltage drop (V)
- R D. C. conductor resistance at operating temperature (Ω /km)
- X Reactance (Ω / km)
- L Cable length (km)
- I Current rating value or load current (A)
- Cos φ Power factor
if no details, power factor is Cos φ = 0.8 and Sin φ = 0.6.

Cos φ	1,0	0,9	0,8	0,71	0,6	0,5
Sin φ	0,0	0,44	0,6	0,71	0,8	0,87

TECHNICAL DATA

PROPERTIES* OF INSULATON AND SHEATH MATERIALS

Designation			Electrical				Thermal						
VDE des.	Code	Material	Density g/cm ³	Electr. strength Break down voltage	Specific insulation Volume resistivity	Dielectr. constant	Service working temperature		Melting point	Flame resistivity	Oxygen LOI % O ₂	Heating value Ho MJ·kg ⁻¹	
				kV/mm	Ω · cm 20 °C	50 Hz/ 20 °C	contin. °C	contin. °C	+°C				
Thermoplastics	Y	PVC	Polyvinyl chloride	1,35-1,5	25	10 ¹³ -10 ¹⁵	3,6-6	-30 +70	+100	>140	self extin- guishing	23-42	17-25
	Yw	PVC	Heat resistance to 90°C	1,3-1,5	25	10 ¹² -10 ¹⁵	4-6,5	-20 +90	+120	>140		24-42	16-22
	Yw	PVC	Heat resistance to 105°C	1,3-1,5	25	10 ¹² -10 ¹⁵	4,5-6,5	-20 +105	+120	>140		24-42	16-20
	Yk	PVC	Cold resistance	1,2-1,4	25	10 ¹² -10 ¹⁵	4,5-6,5	-40 +70	+100	>140		24-42	17-24
	2Y	LDPE	PE (low density)	0,92-0,94	70	10 ¹⁷	2,3	-50 +70	+100	105*110	combus- tible	≤22	42-44
	2Y	HDPE	PE (high density)	0,94-0,98	85	10 ¹⁷	2,3	-50 +100	+120	130		≤22	42-44
	2X	XLPE	Cross-linked polyethylene	0,92	50	10 ¹² -10 ¹⁶	4-6	-35 +90	+100	-		≤22	42-44
	02Y		Polyethylene foam	~0,65	30	10 ¹⁷	~1,55	-40 +70	+100	105		18-30	42-44
	3Y	PS	Polystyrene	1,05	30	10 ¹⁶	2,5	-50 +80	+100	>120		≤22	40-43
	4Y	PA	Polyamide	1,02-1,1	30	10 ¹⁵	4	-60 +105	+125	210		≤22	27-31
	9Y	PP	Polypropylene	0,91	75	10 ¹⁶	2,3-2,4	-10 +100	+140	160		≤22	42-44
	11Y	PUR	Polyurethane	1,15-1,2	20	10 ¹⁰ -10 ¹²	4-7	-55 +80	+100	150		20-26	20-26
	TPE-E (12Y/13Y)		Polyester elastomer	1,2-1,4	40	>10 ¹⁰	3,7-5,1	-50 +100	> 140	190		≤29	20-25
TPE-O (18 Y)		Polyolefin elastomer	0,89-1,0	30	>10 ¹⁴	2,7-3,6	-50 +100	+130	150	≤25		23-28	
Elastomers	G	NR SBR	Natural rubber styrene-butadiene rubber	1,5-1,7	20	10 ¹² -10 ¹⁵	3-5	-65 +60	+120		combus- tible	≤22	21-25
	2G	SIR	Silicone rubber	1,2-1,3	20	10 ¹⁵	3-4	-60 +180	+260	-	low flam- ability	25-35	17-19
	3G	EPR	Ethylene-propylene mixed polymer	1,3-1,55	20	10 ¹⁴	3-3,8	-30 +90	+160	-	combus- tible	≤22	21-25
	4G	EVA	Ethylene-vinyl acetate copolymer	1,3-, 1,5	30	10 ¹²	5-6,5	-30 +125	+200	-		≤22	19-23
	5G	CR	Polychloroprene	1,4-1,65	20	10 ¹⁰	6-8,5	-40 +100	+140	-	self extin- guishing	30-35	14-19
	6G	CSM	Chlorosulfonated polyethylene	1,3-1,6	25	10 ¹²	6-9	-30 +80	+140	+160		30-35	19-23
Hightemp. materials	10Y	PVDF	Polyvinylidene fluoride Kynar® / Dyflor®	1,7-1,9	20	10 ¹⁴	9-7	-40 +135	+160	>170	noncom- bustible	40-45	15
	7Y	ETFE	Ethylentetrafluorethylene Tefzel®	1,6-1,8	36	10 ¹⁶	2,6	-100 +150	+180	>265		30-35	14
	6Y	FEP	Fluorinated ethylene propylene	2,0-2,3	25	10 ¹⁸	2,1	-100 +205	+230	>225		>95	5
	5YX	PFA	Perfluoralkoxy polimer	2,0-2,3	25	10 ¹⁸	2,1	-190 +260	+280	>290		>95	5
	5Y	PTFE	Polytetrafluorethylene	2,0-2,3	20	10 ¹⁸	2,1	-190 +260	+300	>325		>95	5
halogen-free mixtures	H	Not cross linked	Halogen-free polymer mixture	1,4-1,6	25	10 ¹² -10 ¹⁴	3,4-5	-30 +70	+100	>130	self extin- guishing	≤40	17-22
	HX	Cross linked	Halogen-free polymer mixture	1,4-1,6	25	10 ¹³ -10 ¹⁴	3,4-5	-30 +70	+150	-		≤ 40	16-25

* The characteristics are valid for unprocessed material

TECHNICAL DATA

PROPERTIES* OF INSULATION AND SHEATH MATERIALS

	Designation			Thermal			Mechanical				Free from halogens	Weathering		
	VDE des.	Code	Material	Thermal conductivity W·K-1·m-1	Corrosive gases in case of fire	Radiation resist. max. Mrad	Tensile strength N/mm2	Elongation at break %	Shore hardness	Abrasion performance	Water absorption %	halogen free	Weathering resist.	Cold resistance
Thermoplastics	Y	PVC	Polyvinyl chloride mixtures	0,17	Hydrogen chloride	80	10 - 25	130 - 350	70-95 (A)	average	0,4	no	moderate	medium-good
	Yw	PVC	temperature resistance to 90°C											
	Yw	PVC	temperature resistance to 105°C											
	Yk	PVC	low temperature resistance											
	2Y	LDPE	PE (low density)	0,3	no	100	10 - 20	400 - 600	43-50 (D)	average	0,1	yes	good	good
	2Y	HDPE	PE (high density)	0,4										
	2X	XLPE	Cross-linked polyethylene	0,3										
	02Y		Polyethylene foam	0,25										
	3Y	PS	Polystyrene	0,25	no	80	55 - 65	300 - 400	35-50 (D)	good	0,4	yes	medium good	moderately good
	4Y	PA	Polyamide	0,23										
	9Y	PP	Polypropylene	0,19										
	11Y	PUR	Polyurethane	0,25										
		TPE-E (12Y/13Y)	Polyester elastomer	0,5	no	100	30	> 300	85 (A) 70 (D)	good	1,5	yes/no (2)	very good	very good
	TPE-O (18 Y)	Polyolefin elastomer	1,5											
Elastomers	G	NR SBR	Natural rubber styrene-butadiene rubber	-	no	100	300 - 600	60-70 (A)	mod.	1,0	no	moderate	very good	
	2G	SIR	Silicone rubber	0,22										
	3G	EPR	Ethylene-propylene mixed polymer	-										
	4G	EVA	Ethylene-vinyl acetate copolymer	-										
	5G	CR	Polychloroprene- mixtures	-	Hydrogen chloride	50	10 - 20	400 - 700	55-70 (A)	average	1,0	very good	very good	moderately good
	6G	CSM	Chlorosulfonated polyethylene	-										
Hightemp. materials	10Y	PVDF	Polyvinylidene fluoride Kynar® / Dyflor®	0,17	Hydrogen fluoride	10	50 - 80	150	75-80 (D)	very good	0,01	no	very good	
	7Y	ETFE	Ethylene tetrafluorethylene Tefzel®	0,24	yes	10	40 - 50	150	70-75 (D)					
	6Y	FEP	Fluorinated ethylene propylene	0,26	yes	1	15 - 25	250	55-60 (D)					
	5YX	PFA	Perfluoralkoxy	0,21	yes	0,1	25 - 30	250	55-60 (D)					
	5Y	PTFE	Polytetrafluorethylene	0,26	yes	0,1	80	50	55-60 (D)					
Halogen-free mixtures	H	Not cross linked	Halogen-free polymer mixture	0,17	no	100	8 - 13	150 -	65-95 (A)	average	0,2-1,5	yes	moderate	average
	HX	Cross-linked	Halogen-free polymer mixture	0,2	no	200	8 - 13	150 - 250						

* The characteristics are valid for unprocessed material

(1) The propellant may be fluorinated chlorinated hydrocarbons

(2) Depend on type of compound.

TECHNICAL DATA

PROPERTIES OF INSULATION AND SHEATH MATERIALS

Designation			Properties				
VDE des.	Code	Material	Oxidation resistance	Heat resistance	Oil resistance	Ozone resistance	Abrasion resistance
Y	PVC	Polyvinylchloride	E	G-E	F	E	F-G
Yw	PVC	Heat resistance to 90°C					
Yw	PVC	Heat resistance to 105°C					
Yk	PVC	Cold resistance					
2Y	LDPE	PE (low density)	E	G	G-E	E	G
2Y	HDPE	PE (high density)	E	E	G-E	E	E
2X	XLPE	Cross-linked polyethylene	E	G	G	E	F-G
02Y		Polyethylene foam	E	G	G	F	G
3Y	PS	Polystrene	E	E	G	F	G
4Y	PA	Polyamide	E	E	E	E	E
9Y	PP	Polypropylene	E	E	F	E	F-G
11Y	PUR	Polyurethane	E	G	E	E	O
12Y/13Y	TPE-E	Polyester elastomer	E	E	E	E	E
18Y	TPE-O	Polyolefin elastomer	E	E	F	E	F
G	NR	Natural rubber	F	F	P	P	E
	SBR	Styrene butadiene rubber	G	F	P	P	E
2G	SIR	Silicone rubber	E	G	F-G	O	F
3G	EPR	Ethylene-propylene mixed polymer	G	E	F	E	G
4G	EVA	Ethylene-vinyl acetate copolymer	G	G	G	G	G-E
5G	CR	Polychloroprene	G	G	G	G	G-E
6G	CSM	Chlorosulfonated polyethylene	E	E	G	E	G
	CPE	Chlorinated Polyethylene	E	E	E	E	E-O
	EPDM	Ethylene propylene-diene elastomer	E	E	P	E	G
	NBR	Nitrile butadiene rubber	F	G	G-E	P	G-E
	NBR/PVC	Nitrile butadiene rubber / Polyvinylchloride	E	G	G	G	E

P= Poor | F= Fair | G= Good | E= Excellent | O= Outstanding

TECHNICAL DATA

PROPERTIES OF INSULATION AND SHEATH MATERIALS

Designation			Properties						
VDE des.	Code	Material	Water resistance	Acid resistance	Alkali resistance	Aliphatic hydrocarbons resistance (Gasoline, kerosene etc.)	Aromatic hydrocarbons resistance (Benzol, tuluol, etc.)	Halogenated hydrocarbons resistance (Degreaser solvents)	Alcohol resistance
Y	PVC	Polyvinylchloride compounds	F-G	G-E	G-E	P	P-F	P-F	P-F
Yw	PVC	Heat resistance to 90°C							
Yw	PVC	Heat resistance to 105°C							
Yk	PVC	Cold resistance							
2Y	LDPE	PE (low density)	E	G-E	G-E	G-E	P	G	E
2Y	HDPE	PE (high density)	E	E	E	G-E	P	G	E
2X	XLPE	Cross-linked polyethylene	G-E	G-E	G-E	F	F	F	E
02Y		Polyethylene foam	E	G-E	G-E	G	P	G	E
3Y	PS	Polystrene	G	G-E	E	P	P	P	E
4Y	PA	Polyamide	P-F	P-F	E	G	G	G	P
9Y	PP	Polypropylene	E	E	E	P-F	P-F	P	E
11Y	PUR	Polyurethane	P-G	F	F	P-G	P-G	P-G	P-G
12Y/13Y	TPE-E	Polyester elastomer	E	F	F	G-E	E	E	E-O
18Y	TPE-O	Polyolefin elastomer	E	G	G	G-E	E	E	E-O
G	NR	Natural rubber	G-E	F-G	F-G	P	P	G	G-E
	SBR	Styrene butadine rubber	E	F-G	F-G	P	P	P	G
2G	SIR	Silicone rubber	G-E	F-G	F-G	P-F	P	P-G	G
3G	EPR	Ethylene-propylene mixed polymer	G-E	G-E	G-E	P	F	P	P
4G	EVA	Ethylene-vinyl acetate copolymer	G	G	G	G	P-F	P	F
5G	CR	Polychloroprene	G	G	G	G	P-F	P	F
6G	CSM	Chlorosulfonated polyethylene	G-E	E	E	F	F	P	P
	CPE	Chlorinated Polyethylene	E	E	E	G-E	E	E	E-O
	EPDM	Ethylene propylene-diene elastomer	G-E	G-E	G-E	P	F	P	P
	NBR	Nitrile butadine rubber	G-E	G	F-G	E	G	P	E
	NBR/PVC	Nitrile butadine rubber / Polyvinylchloride	E	G	G	G-E	G	G	G

P= Poor | F= Fair | G= Good | E= Excellent | O= Outstanding

TECHNICAL DATA

CHEMICAL RESISTANCE OF INSULATION AND SHEATH MATERIALS

Chemical	Material							
	EPR	PVC	CSM	PCP	PUR	PE	H	SIR
Aceton	+	-	0	0	-	*	*	0
Acetic acid, 20 %	-	-	0	0	0	0	-	*
Aluminium chloride solution	+	+	+	+	*	*	*	-
Aluminium sulfate solution	+	+	0	0	*	*	-	-
Ammonia, anhydrous	+	0	+	+	*	*	*	*
Ammonium chloride solution	+	+	+	+	*	*	+	*
Ammonium hydroxide solution	+	*	+	+	*	*	*	*
Ammonium sulfate solution	+	+	+	+	*	*	*	*
Amyl acetate	0	*	0	0	*	*	*	*
Aniline	0	-	-	-	-	*	*	*
Asphalt	-	0	0	0	+	*	*	*
Benzene	*	-	*	*	-	*	*	-
Benzine	-	-	0	+	+	*	*	*
Benzole	-	-	-	-	-	*	*	*
Borax solution	+	+	+	+	*	*	*	*
Boric acid solution	+	+	+	+	0	+	0	+
Butyl acetate	0	-	-	-	*	*	*	*
Calcium bisulphite solution	+	*	0	0	*	*	*	*
Calcium chloride solution	+	+	+	+	*	*	0	*
Calcium hydroxide solution	+	*	+	+	*	*	*	*
Carbon disulphide	-	-	-	-	*	-	-	-
Carbon tetrachloride	-	+	-	-	-	-	*	-
Chlorobenzene	-	-	-	-	-	*	*	-
Chloroacetic acid	0	*	0	0	*	*	*	*
Chlorine gas, wet	0	-	-	0	*	*	*	*
Chlorine gas, dry	0	-	0	0	*	*	*	*
Chloroform	-	-	-	-	*	*	*	*
Copper chloride solution	+	+	+	+	+	+	0	0
Copper sulphate solution	+	+	+	+	+	+	0	0
Cyclohexane	-	-	0	-	*	*	*	*
Dibutylphtalate	0	-	*	-	*	*	*	*
Diesel oils	*	0	+	+	+	*	-	0
Ethyl acetate	0	-	-	-	*	*	*	*
Ethyl alcohol	+	-	*	*	0	+	-	+
Ethylene glycol	+	0	+	+	*	*	+	*

(+)= Resistant | (0)= Limited resistance | (-)= Non-resistance | (*)= Not tested

TECHNICAL DATA

CHEMICAL RESISTANCE OF INSULATION AND SHEATH MATERIALS

Chemical	Material							
	EPR	PVC	CSM	PCP	PUR	PE	H	SIR
Ethylen oxide	-	*	0	-	*	*	*	*
Formaldehyde, 10%	+	*	+	+	*	*	*	*
Fuel oil	-	0	0	0	0	*	-	*
Glycerine	+	+	+	+	+	*	*	+
Hydraulic oils	-	0	+	+	0	*	-	-
Hydrochloric acid, 20%	+	*	+	0	-	+	-	-
Hydrogen sulphide	+	*	+	0	-	*	-	-
Kerosine	-	0	-	-	+	*	*	*
Lactic acid	+	*	+	0	-	*	*	-
Linseed oil	-	*	0	0	*	*	*	*
Lubricating oils	-	+	0	0	*	*	*	*
Magnesium chloride solution	+	+	+	+	*	*	0	0
Mercury	*	+	+	+	+	+	+	+
Methanol	+	-	+	+	*	-	*	+
Methyl chloride	-	-	-	-	-	*	*	-
Methyl ethyl ketone	+	-	0	0	*	*	*	*
Methyl alcohol	+	0	+	+	0	+	0	*
Mineral oil	-	-	0	0	0	*	*	*
Naphta	-	*	-	0	*	*	*	*
Naphtalene	-	-	-	0	*	*	*	*
Nitric acid, 30%	-	-	-	-	-	-	-	-
Olive Oil	*	*	*	*	+	+	*	+
Perchlor ethylene	-	-	-	-	*	*	*	*
Petroleum	-	-	0	0	0	-	-	-
Phenol	-	-	-	-	*	*	*	*
Phosphoric acid	+	+	+	+	0	+	-	*
Picric acid	+	+	+	+	-	*	*	*
Potassium chloride	+	+	+	+	+	+	-	*
Pyridine	-	-	-	-	*	*	*	*
Sea Water	*	+	+	+	+	+	0	0
Soap solution	+	+	+	+	*	*	*	*
Sodium hydroxide, 25%	+	0	+	+	-	*	*	*
Sodium hypochloride	+	*	+	0	*	*	0	0
Soya bean oil	-	-	0	0	*	*	*	*
Sulphur	+	+	+	+	0	0	*	-

(+)= Resistant | (0)= Limited resistance | (-)= Non-resistance | (*)= Not tested

TECHNICAL DATA

CHEMICAL RESISTANCE OF INSULATION AND SHEATH MATERIALS

Chemical	Material							
	EPR	PVC	CSM	PCP	PUR	PE	H	SIR
Sulphurous acid	+	+	+	0	*	*	*	*
Sulphuric acid < 50%	+	+	+	+	-	*	*	*
Stearic acid	+	0	+	+	*	*	*	*
Toluene	-	-	-	-	*	*	*	-
Transformer oil	-	+	+	+	+	*	*	*
Tributyl phosphate	0	*	-	0	*	*	*	*
Trichlorethylene	*	0	0	0	-	*	*	+
Triethanolamine	+	*	+	0	*	*	*	*
Turpentine	-	-	-	-	*	*	*	*
Vegetable oils and grease	0	0	+	+	+	+	-	*
Water (dist.)	+	+	+	+	0	*	*	*
Xylene	-	-	-	-	*	*	*	*
Zinc chloride solution	+	+	+	+	-	*	0	*

(+)= Resistant | (0)= Limited resistance | (-)= Non-resistance | (*)= Not tested

TECHNICAL DATA

BASIC CABLE ELECTRICAL DEFINITIONS AND FORMULAS

Cable

In electrical and electronic systems, a conductor or group of individually insulated conductors in twisted or parallel configuration under common sheath for transmitting electric power, energy or telecommunication signals or data from one place to another

Voltage

Voltage is defined as the electrical potential difference per unit charge between two points in the electric field. The unit of voltage is Volt (V). For the rated, operating and test voltages of cables, the definitions given in DIN VDE 0298, Part 3, like AC = Alternating Current and DC = Direct Current

Current

Electric current is defined as a flow of charged particles (electrons and ions) moving through a conductor. It is also defined as the flow rate of electric charge through a conducting medium concerning time.

The unit of electric current is ampere (A). And the electric current is denoted mathematically by the symbol 'I' or 'i'.

Current Carrying Capacity

The maximum current an insulated conductor or cable can continuously carry without exceeding its temperature rating. It is also called Ampacity.

Resistance

Resistance or electrical resistance measures the opposition to current flow in an electrical circuit. Resistance is measured in ohms (Ω). Resistance of any conducting material is directly proportional to length of material, and inversely proportional to the area of conductor.,

Capacitance

Storage of electrically separated charges between two plates having different potentials. The value depends largely on the surface area of the plates and the distance between them.

Capacitance, Direct: The capacitance measured directly from conductor to conductor through a single insulating layer.

Capacitance, Mutual: The capacitance between two conductors with all other conductors, including shield, short circuited to ground.

Impedance

The total opposition that a circuit offers to the flow of alternating current or any other varying current at a particular frequency. It is a combination of resistance (R) and reactance (X), measured in ohms.

Characteristic Impedance: The impedance that, when connected to the output terminals of a transmission line of any length, makes the line appear infinitely long. The ratio of voltage to current at every point along a transmission line on which there are no stranding waves

Inductance

Inductance is the property of wire which stores electrical current in a magnetic field around the wire and is an electrochemical characteristic of an electric conductor or circuit that induces an electromotive force to be released when the current flowing changes. It refers to the electrical conductor's resistance to change in the electric current travelling through it. It is measured in Henrys.

Reactance

A measure of the combined effects of capacitance and inductance on an alternating current or the opposition offered to the flow of alternating current by inductance or capacitance of a component or circuit. The amount of such opposition varies with the frequency of the current. The reactance of a capacitor decreases with an increase in frequency; the opposite occurs with an inductance.

Electric Power

Power is the rate of energy supplied or consumed by an electric element with respect to time.

The pace at which electrical energy is transferred by an electric circuit is referred to as power, which is measured in Watts. Power can be determined as the Force multiplied by distance divided by the time required.

Power Factor

The power factor is a very important term in case of the AC system. It is defined as a ratio of working power absorb by the load to the apparent power flowing through the circuit.

$$\text{Power Factor } \cos\phi = \frac{\text{Active Power}}{\text{Apparent Power}}$$

The power factor dimensions less number in the closed interval of -1 to 1. When the load is resistive, power factor is near to 1 and when the load is reactive, power factor is near to -1.

Frequency

Frequency is defined as the number of cycles per unit time. It is denoted as f and measured in Hertz (Hz). One hertz is equal to one cycle per second. Generally, the frequency is 50 Hz or 60 Hz.

Electric Field

An electric field is a field or space around an electrically charged object where any other electrically charged object will experience a force. An electric field is also known as electric field intensity or electric field strength, denoted by E.

Electromagnetic compatibility - EMC

Electromagnetic compatibility is the capability of an electrical or electronic device to function correctly in its electromagnetic environment and not to cause interference to the environment to an impermissible degree.

TECHNICAL DATA

BASIC CABLE ELECTRICAL DEFINITIONS AND FORMULAS

Resistance

The values of conductor DC resistance are dependant on the temperature and it is calculated by the following formula:

$$R_{\theta} = R_{20}[1 + \alpha (\theta - 20)] \quad \Omega/\text{km}$$

where,

R_{θ}	:	The conductor DC resistance at $\theta^{\circ}\text{C}$	Ω/km
R_{20}	:	The conductor DC resistance at 20°C	Ω/km
θ	:	Operating temperature	$^{\circ}\text{C}$
α	:	Temperature coefficient	$1/^{\circ}\text{C}$
		= 0.00393 for Copper	
		= 0.00403 for Aluminum	

Generally the Dc resistance is based on IEC 60228 and to calculate the AC resistance of the conductor at the operating temperature the following

$$R_{AC} = R_{\theta}(1 + Y_S + Y_P) \quad \Omega/\text{km}$$

where,

Y_S	:	Skin effect factor
Y_P	:	Proximity effect factor

Inductance

$$L = K + 0.2 \ln (2S/d)$$

where,

L	:	The Inductance	mh/km
K	:	Constant depend on number of wires	
d	:	Conductor diameter	
S	:	Axial Spacing	
		= 1.26 x axial spacing between cables in case of flat formation	

Reactance

$$X = 2 \pi f L \times 10^{-3} \quad \Omega/\text{km}$$

where,

X	:	The Cable Reactance	Ω/km
L	:	The Inductance	mh/km
f	:	Frequency	Hz

Impedance

$$Z = \sqrt{X^2 + R_{AC}^2} \quad \Omega/\text{km}$$

Capacitance

$$C = \frac{\epsilon_r}{18 \ln \frac{D}{d}} \quad \mu\text{F}/\text{km}$$

where,

C	:	Capacitance	$\mu\text{F}/\text{km}$
ϵ_r	:	Relative permittivity of insulation material	
		4,8 for PVC	
		2,3 for XLPE	
D	:	Diameter over insulation	mm
d	:	Diameter under insulation	mm

TECHNICAL DATA

General Information

Insulation resistance

The insulation resistance is formulated as following:

$$R = K \ln(D/d) \quad \text{M}\Omega/\text{km}$$

where,

R	:	Insulation resistance	MΩ/km
K	:	Constant depending on the insulation material	MΩ/km
d	:	diameter under the insulation	mm
D	:	diameter over the insulation	mm

Charging Current

The charging current is the capacitive current which flows through the dielectric layers when AC voltage is applied. The value can be calculated from the following equation:

$$I_c = U_0 \omega C 10^{-6} \quad \text{A/Km}$$

where,

I _c	:	Charging current	A/Km
U ₀	:	Rated phase voltage	V
ω	:	Angular of velocity (2πf)	
f	:	Frequency	Hz
C	:	Capacitance	μf/Km

Dielectric losses

The dielectric losses of an AC cable are proportional to the capacitance, the frequency, the phase voltage squared and the power factor. The value can be derived from the following equation:

$$W_d = \omega C U_0^2 \tan \delta 10^{-6} \quad \text{watt/Km/phase}$$

where,

W _d	:	Dielectric losses	watt/Km/phase
f	:	Frequency	Hz
C	:	Capacitance	μf/Km
U ₀	:	Rated phase voltage	V
tanδ	:	Dielectric power factor	
ω	:	Angular of velocity (2πf)	

TECHNICAL DATA

Conductor resistance

$$R = \frac{\rho \cdot L}{S}$$

$$R = \frac{L}{\kappa \cdot S}$$

$$G = \frac{1}{R}$$

$$\rho = \frac{1}{\kappa}$$

R = electrical resistance in Ω
 G = electrical conductivity in S
 S = conductor cross-section in mm^2
 L = length of conductor in m
 ρ = specific resistance (Rho)
 κ = conductivity (Kappa)

Materials	Conductivity $\frac{\text{m}}{\Omega \cdot \text{mm}^2}$	Spec. resistance $\frac{\Omega \cdot \text{mm}^2}{\text{m}}$
Copper	58,00	0,01724
Aluminium	33,00	0,0303

Cross section for single wire round

$$q = \frac{D^2 \cdot \pi}{4} \quad \text{or} \quad D^2 \cdot 0,7854$$

Cross section for bunched wire

$$q = \frac{d^2 \cdot \pi}{4} \cdot n \quad \text{or} \quad d^2 \cdot 0,7854 \cdot n$$

Diameter for single wires cross-section

$$q = \sqrt{\frac{q \cdot 4}{\pi}} \quad \text{or} \quad \sqrt{q \cdot 1,2732}$$

Diameter for bunched wires

$$D = \sqrt{1,34 \cdot n \cdot d}$$

q = cross-section (mm^2)

D = conductor diameter (mm)

d = single wire diameter (mm)

n = number of wires

TECHNICAL DATA

Current - Voltage - Power - Resistance Equations

Quantity	DC	Single Phase AC	Three Phase AC
Current (I)	$I = V / R$ $I = P / V$ $I = \sqrt{P / R}$	$I = P / (V \times \text{Cos}\theta)$ $I = (V / Z)$	$I = P / \sqrt{3} \times V \times \text{Cos}\theta$
Voltage (V)	$V = I \times R$ $V = P / I$ $V = \sqrt{(P \times R)}$	$V = P / (I \times \text{Cos}\theta)$ $V = I / Z$	$V_L = \sqrt{3} \times V_{PH}$
Power (P)	$P = I \times V$ $P = I^2 \times R$ $P = V^2 / R$	$P = V \times I \times \text{Cos}\theta$ $P = I^2 \times R \times \text{Cos}\theta$ $P = (V^2 / R) \times \text{Cos}\theta$	$P = \sqrt{3} \times V_L \times I_L \times \text{Cos} \Phi$ $P = 3 \times V_{PH} \times I_{PH} \times \text{Cos} \Phi$
Resistance (R)	$R = V / I$ $R = P / I^2$ $R = V^2 / P$	$Z = \sqrt{(R^2 + X_L^2)}$ $Z = \sqrt{(R^2 + X_C^2)}$ $Z = \sqrt{(R^2 + (X_L - X_C)^2)}$	

Where:

- I = Current in Amperes (A)
- V = Voltage in Volts (V)
- P = Power in Watts (W)
- R = Resistance in Ohm (Ω)
- Z = impedance = Resistance of AC Circuits in Ohms
- Cos θ = Power factor = Phase difference between voltage and current in AC circuits
- V_{PH} = Phase Voltage
- V_L = Line Voltage
- X_L = Inductive reactance
- X_L = 2 π fL... Where L = Inductance in Henry
- X_C = Capacitive reactance
- X_C = 1/2 π fC... Where C = Capacitance in Farads. Also, $\omega = 2\pi$ f

TECHNICAL DATA

CONVERSION OF MEASUREMENT UNITS

Length			
1 mil	=	0,0254	mm
1 in (inch)	=	25,4	mm
1 ft (foot)	=	0,305	m
1 yd (yard)	=	0,914	m
1 ch (chain)	=	20,1	m
1 mile (land mile)	=	1609	km
		1760	yards
1 mile (nautic mile)	=	1,852	km
1 mm	=	0,039370	inches
1 m	=	39,370079	inches

Area			
1 CM (circ. mil)	=	$0,507 \cdot 10^{-3}$	mm ²
1 MCM	=	0,5067	mm ²
1 sq. inch (sq. inch)	=	645,16	mm ²
1 sq. ft. (sq. foot)	=	0,0929	m ²
1 square yard	=	0,836	m ²
1 acre	=	4047	m ²
1 square mile	=	2,59	km ²

Volume			
1 cubic inch	=	16,39	cm ³
1 cubic foot	=	0,0283	m ³
1 cubic yard	=	0,765	m ³
1 pint	=	0,473	l
1 quart	=	0,946	l
1 Brit. gallon	=	4,55	l
1 US gallon	=	3,79	l
1 US barell	=	158,8	l

Mass			
1 grain	=	64,8	mg
1 dram	=	1,77	g
1 ounce (oz)= 16 drams	=	28,35	g
1 pound (lb)= 16 oz	=	453,59	g
1 stone = 14 lbs	=	6,35	kg
1 US ton (short ton)	=	907	kg
1 Brit. ton (long ton)	=	1,016	kg

Density			
1 lb/cu.ft	=	16,02	kg/m ³
1 lb/cu.in	=	27,68	t/m ³

Temperature			
F (Fahrenheit)	=	$(1,8 \times C) + 3^0$	
C (Celcius)	=	$0,5556 \times (F-32^0)$	

Force			
1 lb	=	4,448	N
1 brit. ton	=	9954	N
1 pdl (Poundal)	=	0,1383	N
1 kp	=	9,81	N
1 N	=	0,102	kp

Energy			
1 hp x h	=	1,0139	PS x h
	=	$2,684 \times 100000$	J
	=	746	W x h
1 BTU (brit. therm.unit)	=	1055	Joul

Power			
1 PS	=	0,736	kW
1 kW	=	1,36	PS
1 hp	=	0,7457	kW
1 kW	=	1,31	hp

Electrical units			
1 ohm/1000 yd	=	1,0936	Ω /km
1 ohm/1000 ft	=	3,28	Ω /km
1 μ F/mile	=	0,62	μ F/km
1 megohm/mile	=	1,61	M Ω /km
1 $\mu\mu$ f/foot	=	3,28	pF/m
1 decibel/mile	=	71,5	mN/m

Abbreviations for multiples and submultiples			
Prefix	mark	power	name
Tera	T	10^{12}	billion*
Giga	G	10^9	milliard*
Mega	M	10^6	million
Kilo	k	10^3	thousandth
Hekto	h	10^2	hundred
Deka	da	10^1	ten
Piko	p	10^{-12}	billionth*
Nano	n	10^{-9}	milliarth*
Mikro	μ	10^{-6}	millionth
Milli	m	10^{-3}	thousandth
Zenti	c	10^{-2}	hundredth
Dezi	d	10^{-1}	tenth

* In USA 10^9 indicates a billion and 10^{12} indicates a trillion

TECHNICAL DATA

SOME OF MAIN TESTS FOR HFFR CABLES

IEC 60332/3 Fire test on bunched and vertical laid cables.
Test chamber

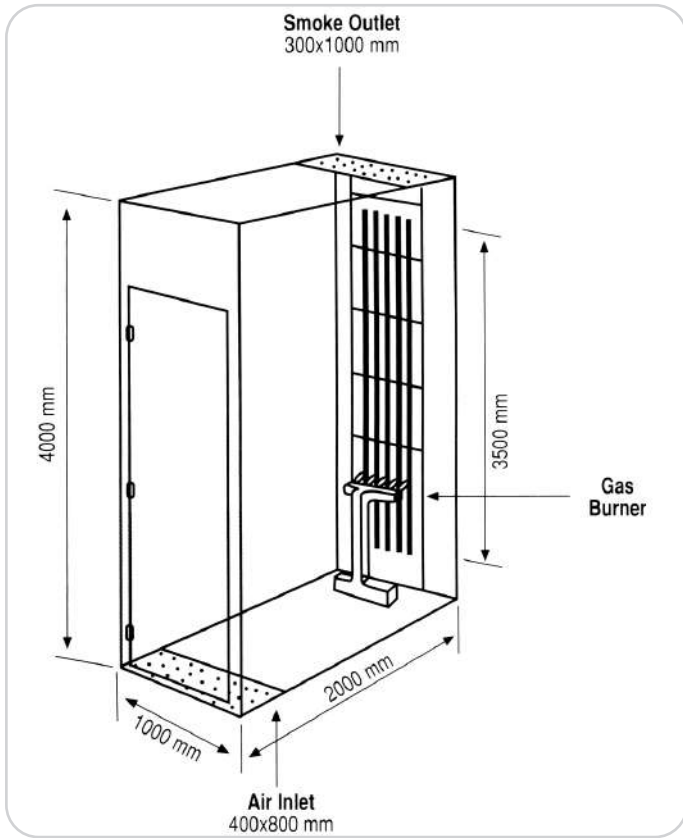

Flame application time

Required volume of combustible material per 1 m of cable bunch (lt) : V

IEC 60332/3 CATEGORY	V	MINIMUM BURNING TIME
A	7lt.	40 minutes
B	3.5lt.	40 minutes
C	1.5lt.	20 minutes

Test Conditions of IEC 60332/3

This test is to determine the fire propagation characteristics of a bunch of cables. The test should be carried out if the external wind speed measured by an anemometer fitted on the top of the test rig is not greater than 5 m/s and the temperature of the walls of the test chamber is in between 5 °C and 40 °C. The temperature inside of the chamber should be 23±5 °C before the test

IEC 60331 - 21 Fire Test for circuit integrity

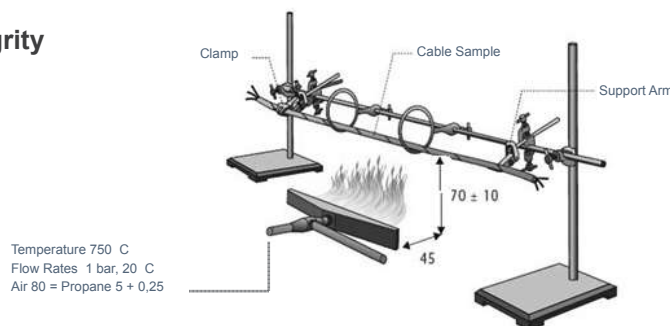

IEC 60332/1 Fire test on a vertical laid single cable. Test chamber

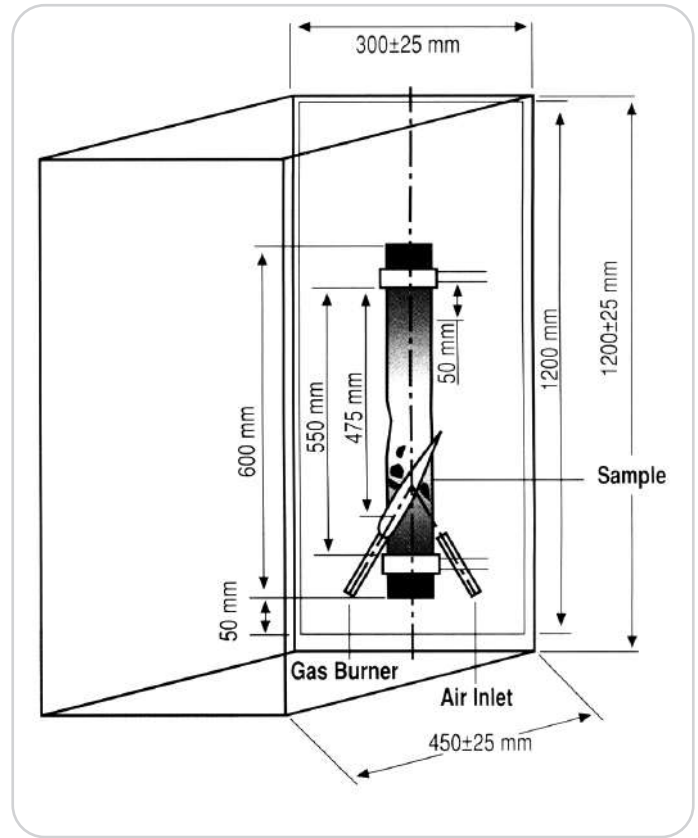

Flame application time

Weight of test piece (kg) : m
Flame application time (s) = 60+m/25

TECHNICAL DATA

Smoke Intensity

IEC 61034-2 / EN 61034-2 / DIN VDE 0482-1034-2

Cable bundle to be tested will be placed inside a metal tray containing $\pm 1\%$ alcohol mixture per 1 liter and will be ignited inside a cabinet with a size of 3 m^3 .

100W standard halogen and photocell based lamp and photometric system is positioned inside a cube with a height of 215 cm ($\pm 10 \text{ cm}$), in the horizontal position on a medium vertical axis. Light transmission of the generated smoke is measured optically.

- Test equipment and flame verification must be in compliance with IEC/EN 61034-1 Standard.

Overall Diameter mm	Sample Number	Light Transmission
$D > 40$	1	$> 60 \%$
$20 < D \leq 40$	2	$> 60 \%$
$10 < D \leq 20$	3	$> 60 \%$
$5 < D \leq 10$	N_1	$> 60 \%$
$1 < D \leq 5$	N_2	$> 60 \%$

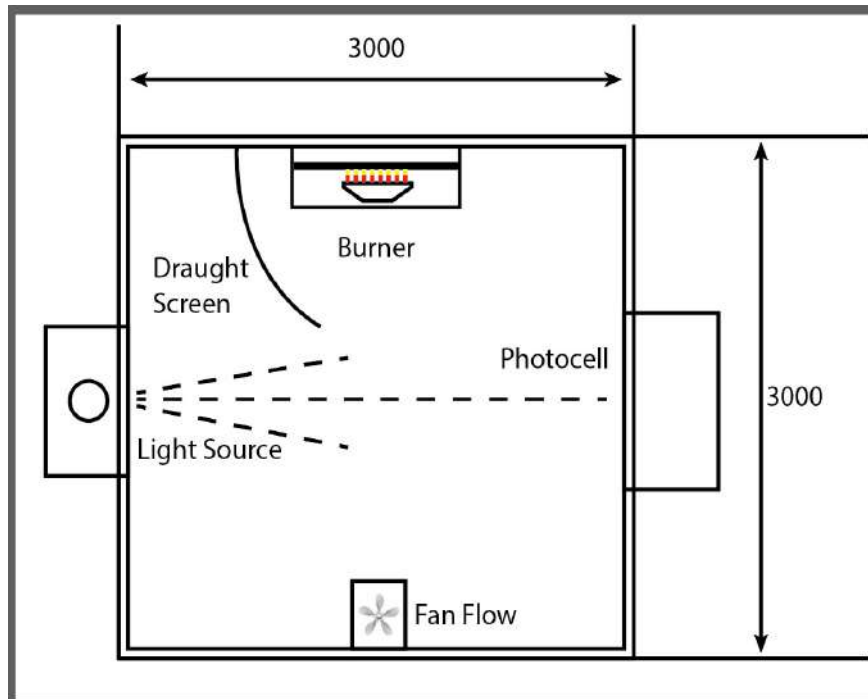

Compliance Requirement

In order for the cable to pass the test, light absorption assessed in photometric terms should be seen within 40 minutes. Also minimum 60% light transmission should be obtained. In such a case, the cable passes the test.

TECHNICAL DATA

pH Measurement and Conductivity Test

IEC 60754-2 / EN 60754-2

Cable to be subjected to this test which allows measuring corrosive gas emission of insulation or outer sheath composition must be 1 gram. Cable's insulation or outer sheath composition is heated at a temperature of 935°C. Gases formed as the result of test that lasts for 30 minutes are dissolved in distilled water with pH and conductivity. Halogen is calculated accordingly.

- Test equipment and flame verification must be in compliance with EN 50267-1 Standard.

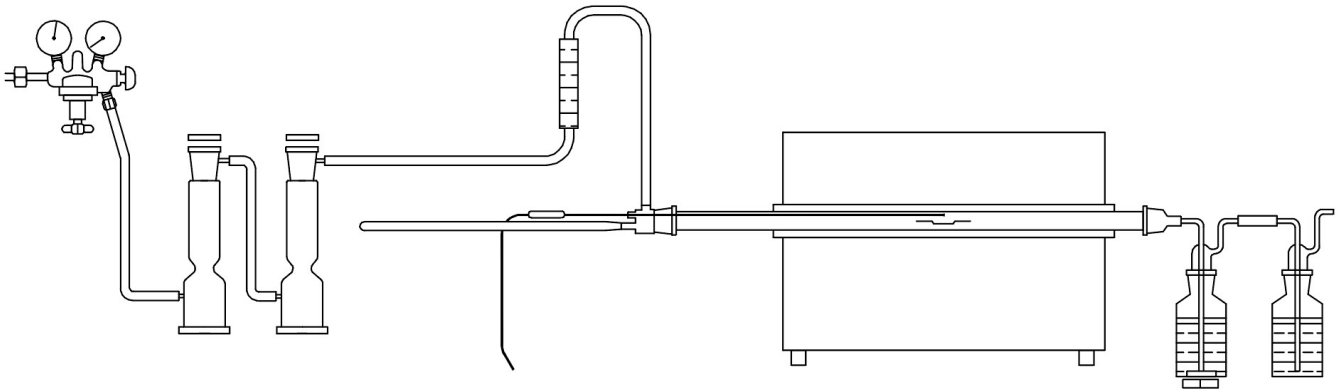

Test apparatus - method 2

Compliance Requirement

In order for the cable to pass the test, pH value measured should be 4.3 or higher. Also it is expected for the electrical conductivity to be 10 μ S/mm or less.

TECHNICAL DATA

CONSTRUCTION PRODUCTS REGULATION - CPR

What is the CPR?

CPR is an acronym for the European Construction Product Regulation (CPR). Any product manufactured and launched on the market that will constitute a permanent part of a building, and which performance will affect the performance of the Building.

The fire properties of cables are important for fire safety in buildings and due to this importance cables have been included in the European classification system under the CPR (Construction Products Regulation) and EN 50575:2014 standard describes "Power, control and communication cables – Cables for general applications in construction works subject to reaction to fire requirements".

EN 50575:2014 standard describes "Power, control and communication cables – Cables for general applications in construction works subject to reaction to fire requirements". Effective 1 July 2016, cable manufacturers may include CE marking on those of their products that have been tested and certified by a notified body, and issue a corresponding Declaration of Performance.

Power, Control, Communication and Optical Fiber cables which are permanently installed in structures is governed by EU Regulation 305/2011 (known as the "Construction Products Regulation"). The Construction Products Guideline 89/10/EEC has been superseded by the Construction Products Regulation (CPR) 305/2011.

At the moment the Regulation does not apply to lift cables, cables inside machinery and cables for use in industrial plant and marine, shipboard and offshore cables as well.

The EU Construction Products Regulation defines the conditions for CE marking and also requires manufacturers to issue a Declaration of Performance regarding the following key product features derived from the protection goals: fire safety (flame propagation, heat development, smoke production, acid formation, and flaming droplets) and the absence of harmful constituents.

Starting from 01 July 2017, the inclusion of CE marking and the issuing of a Declaration of Performance will become mandatory.

The Declaration of Performance certifies compliance with the fire classes and thus forms the requirement for using the cables for the applications defined by the EU countries.

Cables offering insulation and total system integrity (resistance to fire) will be treated in a separate standard to be harmonized in the future. Accordingly, they are neither governed by the current implementation of the Construction Products Regulation (CPR) nor is an application of the CPR to these kinds of cables expected before 2017.

For detailed information you can refer to below web-links;

<http://eur-lex.europa.eu/eli/reg/2011/305/oj>

https://ec.europa.eu/growth/sectors/construction/product-regulation_en

EN 50399 Common test methods for cables under fire conditions

EN 50399 specifies the test apparatus and test procedures for the assessment of the reaction to fire performance of cables to enable classification under the Construction Products Directive to be achieved.

The test method describes an intermediate scale fire test of multiple cables mounted on a vertical cable ladder and is carried out with a specified ignition source to evaluate the burning behavior of such cables and enable a direct declaration of performance.

The following parameters may be determined under defined conditions during the test:

- flame spread;
- heat release rate;
- total heat release;
- smoke production rate;
- total smoke production;
- fire growth rate index;
- occurrence of flaming droplets/particles

TECHNICAL DATA

CONSTRUCTION PRODUCTS REGULATION - CPR

Euro Classification of Cables:

The fire behavior classes are summarized in the following table, which classifies the requirements from Aca (non-flammable) to B1ca or B2ca (very high), Cca (high), Dca (moderate), Eca (low) and Fca (no requirement). The index “ca” stands for cable.

Digit 1: Fire propagation and heat emission performance, cable class (Aca, B1ca, B2ca, Cca, Dca, Eca, Fca).

Aca	They do not contribute to the fire.
B1ca -B2ca	Minimum contribution to the fire.
Cca – Dca – Eca	Combustible, they contribute the fire, from lower to higher contribution.
Fca	Undetermined contribution properties.

Digit 2: Smoke emission properties (s1, s1a, s1b, s2, s3).

This classification provides information about the opacity of the emitted smoke (s: smoke).

s1	Little smoke production and slow smoke propagation.
s1a	Transmittance >80%.
s1b	Transmittance >60% and <80%.
s2	Average smoke production and propagation.
s3	None of the above.

Digit 3: Burning droplets/particles (d0, d1, d2).

This classification provides information about the dripping of burning material during the fire (d: droplet).

d0	No burning droplets or particles.
d1	No burning droplets or particles that last more than 10 seconds.
d2	None of the above.

Digit 4: Acidity performance (a1, a2, a3) in addition applying the test described in standard EN 50267-2-3.

This classification provides information about the emission of acid gases during the fire (a: acidity).

a1	Conductivity < 2,5 µS/mm and pH > 4,3.
a2	Conductivity < 10 µS/mm and pH > 4,3.
a3	None of the above.

This performance code (fire reaction class and additional classification) according to the CPR must appear in the cable marking and in packing together with the rest of the marks. This classification system ranks equally in all European Union countries.

Assessment and Verification of Constancy of Performances

Depending on the main class of a product, a specific conformity procedure (AVPC) must be applied by the manufacturer. The systems 1+, 3 and 4 have been assigned for cable products. Depending on the system, different tasks are required of the manufacturer and the notified body. These tasks include production control and sample testing by the manufacturer, as well as an evaluation of the product performance, ongoing monitoring and product audits by the notified body.

System 1+

Classes B2ca and Cca—**Third Party Notified Body** issues a Certificate based on:

- Initial Type Test
- Factory Audit and regular factory production control (2 times per year)
- Audit Test (once per year on up to 4 families) on product taken from the warehouse

System 3

Classes Dca and Eca—**Third party Notified Laboratory** issues a Laboratory report based on:

- Initial Type Test on product sent by Manufacturer

System 4

Class Fca – The producer prepares and shows on demand an AVCP (similar in future to LVD)

TECHNICAL DATA

CLASSES OF REACTION TO FIRE PERFORMANCE FOR ELECTRIC CABLES

Class	Test method(s)	Classification criteria	Additional classification
A _{ca}	EN ISO 1716	PCS ≤ 2,0 MJ/kg ⁽¹⁾	
B1 _{ca}	EN 50399 (30 kW flame source) and	FS ≤ 1,75 m and THR _{1200s} ≤ 10 MJ and Peak HRR ≤ 20 kW and FIGRA ≤ 120 Ws ⁻¹	Smoke production ^(2,5) and Flaming droplets/particles ⁽³⁾ and Acidity ⁽⁴⁾
	EN 60332-1-2	H ≤ 425 mm	
B2 _{ca}	EN 50399 (20,5 kW flame source) and	FS ≤ 1,5 m; and THR ₁₂₀₀ ≤ 15 MJ; and Peak HRR ≤ 30 kW; and FIGRA ≤ 150 Ws ⁻¹	Smoke production ^(2,6) and Flaming droplets/particles ⁽³⁾ and Acidity ⁽⁴⁾
	EN 60332-1-2	H ≤ 425 mm	
C _{ca}	EN 50399 (20,5 kW flame source) and	FS ≤ 2.0 m; and THR _{1200s} ≤ 30 MJ; and Peak HRR ≤ 60 kW; and FIGRA ≤ 300 Ws ⁻¹	Smoke production ^(2,6) and Flaming droplets/particles ⁽³⁾ and Acidity ⁽⁴⁾
	EN 60332-1-2	H ≤ 425 mm	
D _{ca}	EN 50399 (20,5 kW flame source) and	THR _{1200s} ≤ 70 MJ; and Peak HRR ≤ 400 kW; and FIGRA ≤ 1300 Ws ⁻¹	Smoke production ^(2,6) and Flaming droplets/particles ⁽³⁾ and Acidity ⁽⁴⁾
	EN 60332-1-2	H ≤ 425 mm	
E _{ca}	EN 60332-1-2	H ≤ 425 mm	
F _{ca}	No performance determined		

(1) For the product as a whole, excluding metallic materials, and for any external component (i.e. sheath) of the product.

(2) s1 = TSP_{1200s} ≤ 50 m² and Peak SPR ≤ 0.25 m²/s

s1a = s1 and transmittance in accordance with EN 61034-2 ≥ 80 %

s1b = s1 and transmittance in accordance with EN 61034-2 2 ≥ 60 % < 80 %

s2 = TSP_{1200s} ≤ 400 m² and Peak SPR ≤ 1,5 m²/s

s3 = not s1 or s2

(3) d0 = No flaming droplets/particles within 1200 s; d1= No flaming droplets/ particles persisting longer than 10s within 1200 s; d2 = not d0 or d1.

(4) EN 50267-2-3: a1 = conductivity < 2,5 μS/mm and pH > 4,3; a2 = conductivity < 10 μS/mm and pH > 4,3; a3 = not a1 or a2. No declaration= No Performance Determined.

(5) The smoke class declared for class B1ca cables shall originate from the test according to EN 50399 (30 kW flame source)

(6) The smoke class declared for class B2ca, Cca, Dca cables shall originate from the test according to EN 50399 (20,5 kW flame source)

TECHNICAL DATA

DRUM HANDLING AND STORAGE

1.1.Position of Drums

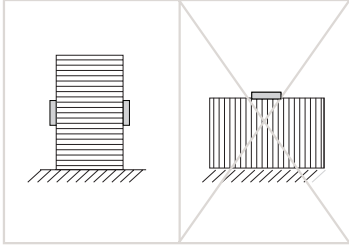

1.2.Loading

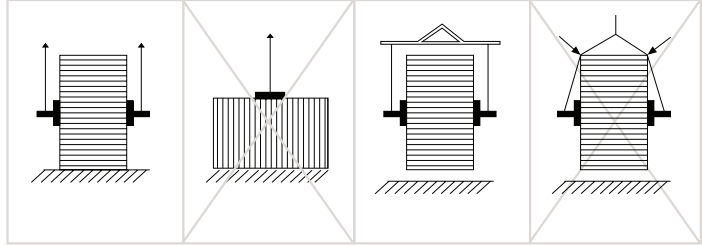

1.3.Unloading

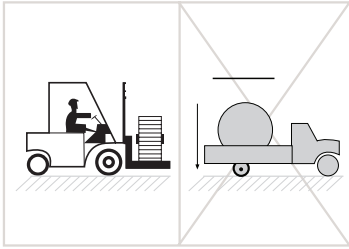

1.4.Handling by forklift

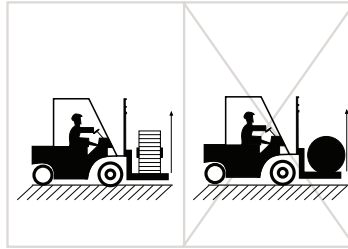

1.5.Rolling

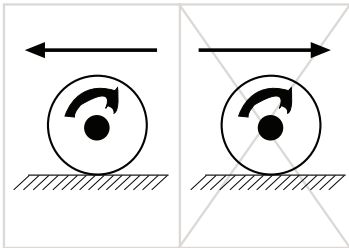

1.6.Paying-off the Cable

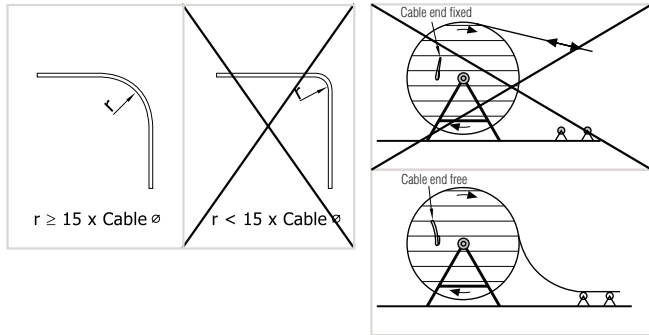

Transport Requirements

2.1.Position of the Drums

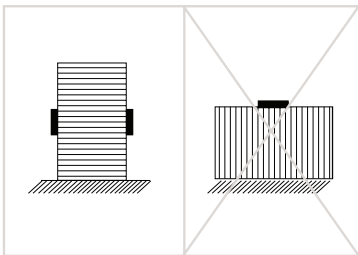

2.2.Fastening Drums

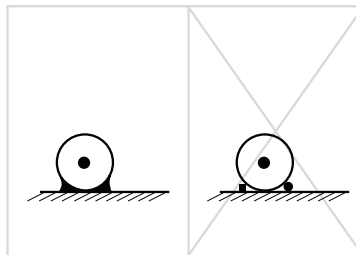

Cables and Drums User Guide

2.3.Use of nails

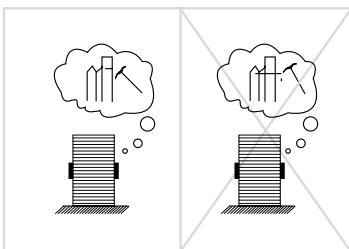

2.4.Bigger Drums

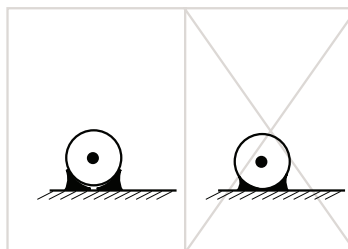

TECHNICAL DATA

DRUM HANDLING AND STORAGE

2.5. Binding of the Drums

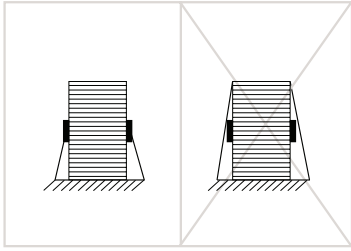

2.6. Multiple Drum Storage

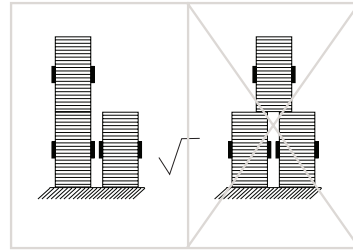

Storage Requirements

3.1. Do not store near heat sources

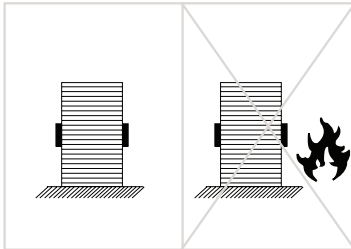

3.2. Do not store on vibrating surfaces. (Ship engine room etc.)

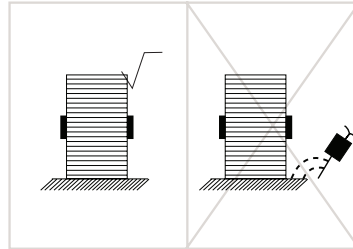

3.3. Do not store on irregular surfaces.

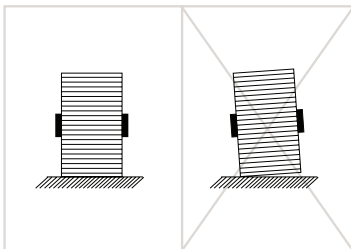

3.4. Do not store on soft surfaces

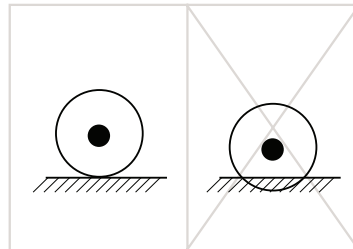

Cables and Drums User Guide

3.5. Do not store on areas liable of flooding. All cable ends must be fully sealed at all times to prevent the ingress of water. It is preferable to store reels off the ground on timbers or other supports. In damp locations, it is advisable to allow at least 3 inches between reels to permit circulation of air.

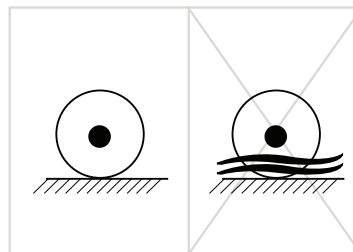

3.6. If storage is likely to last more than 6 months, drums should be stored in order to be protected from effects like rain, sunlight etc.

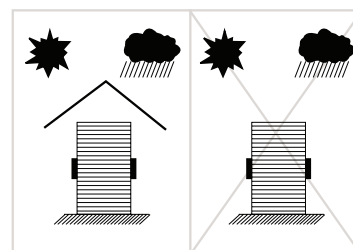

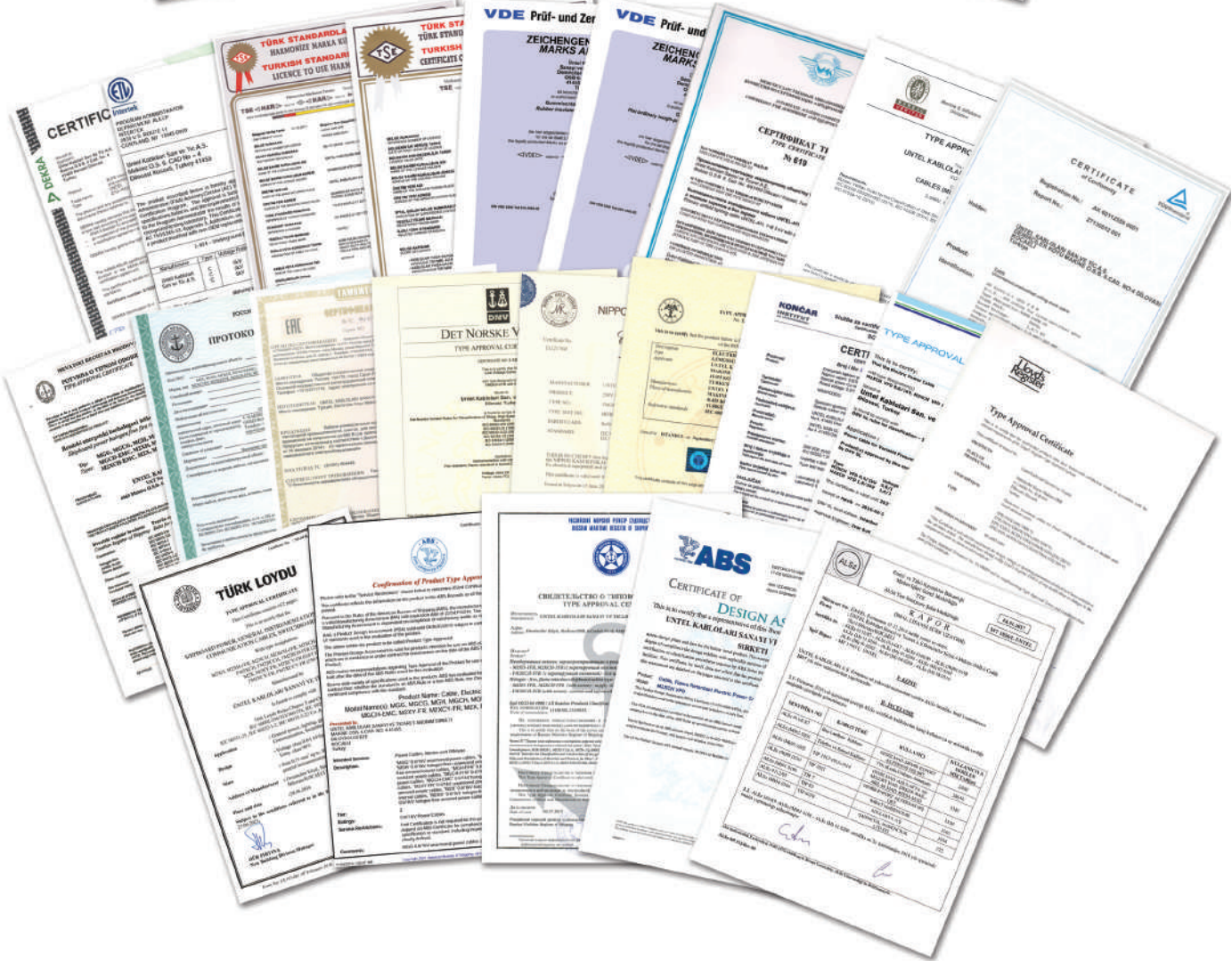
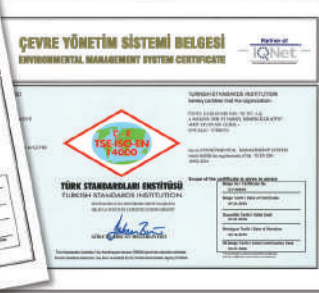
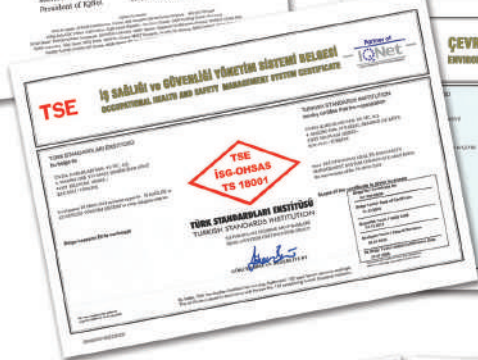

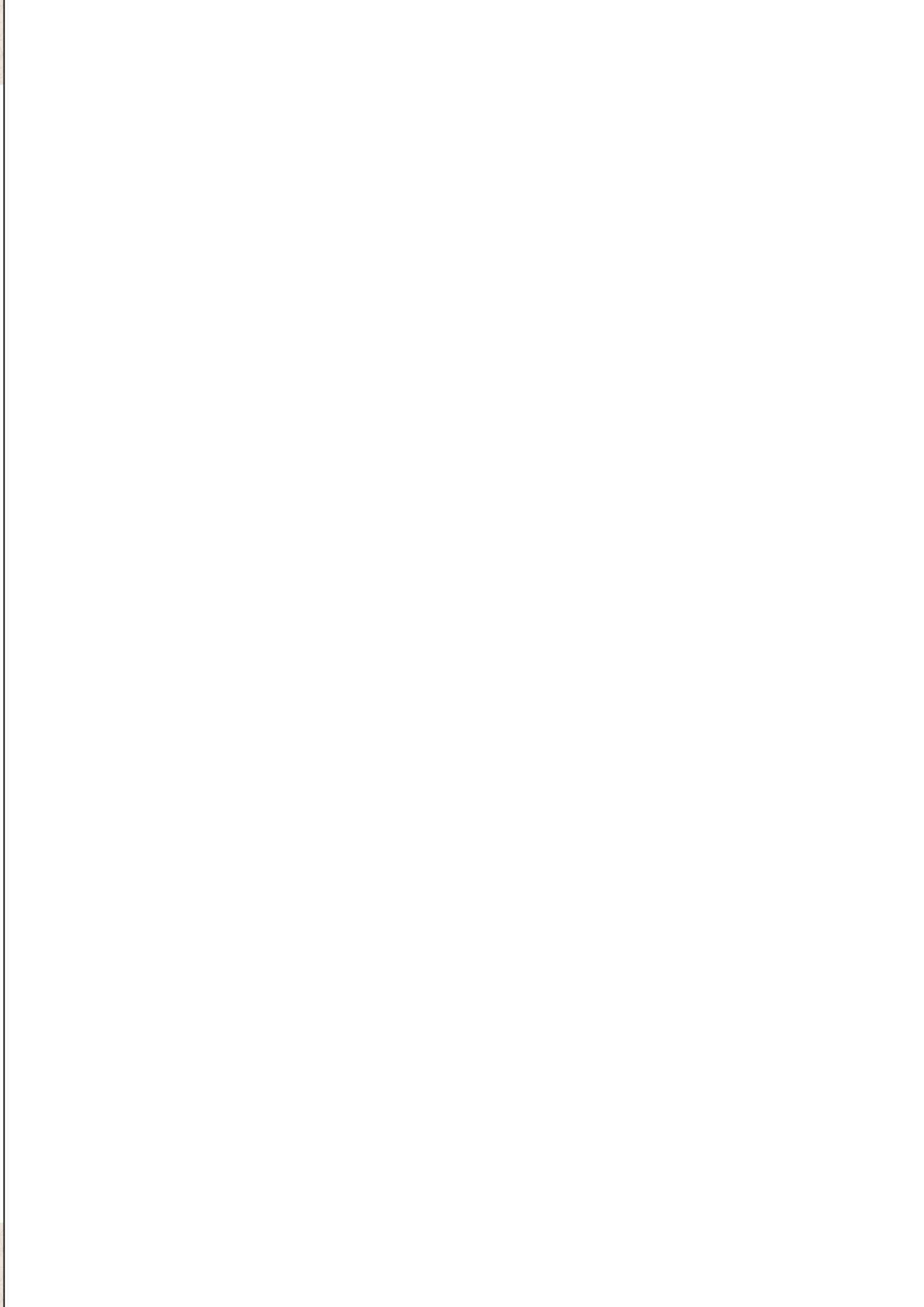

**OFFSHORE
CABLES**



**AIRPORT
CABLES**



**CRANE
CABLES**



**MINING
CABLES**



**DEFENSE
INDUSTRY
CABLES**

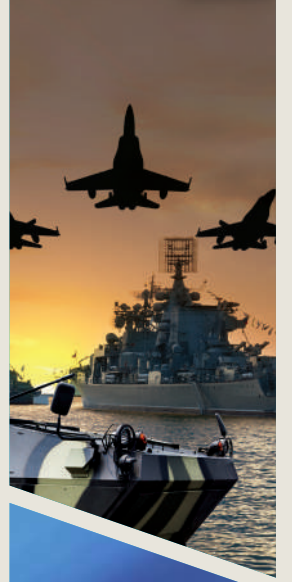

**MARINE
CABLES**



**RAILWAY
CABLES**



**INDUSTRIAL
CABLES**



**TUNNELLING
CABLES**



**INSTRUMENTATION
CABLES**



Üntel Kabloları San. ve Tic. A.Ş.

Makine O.S.B. 6. Cadde No:4/41455 Dilovası, Kocaeli - TÜRKİYE

Tel: +90 262 722 93 30 Fax: +90 262 722 94 43

info@untel.com.tr | www.untel.com.tr